

7-25-2016

Cell and Molecular Biology : What We Know & How We Found It (Second Edition, An Annotated iText)

Gerald Bergtrom

University of Wisconsin - Milwaukee, bergtrom@uwm.edu

Follow this and additional works at: https://dc.uwm.edu/biosci_facbooks_bergtrom

Recommended Citation

Bergtrom, Gerald, "Cell and Molecular Biology : What We Know & How We Found It (Second Edition, An Annotated iText)" (2016).
Cell and Molecular Biology 3e: What We Know and How We Found Out - All Versions. 5.
https://dc.uwm.edu/biosci_facbooks_bergtrom/5

This Book is brought to you for free and open access by UWM Digital Commons. It has been accepted for inclusion in Cell and Molecular Biology 3e: What We Know and How We Found Out - All Versions by an authorized administrator of UWM Digital Commons. For more information, please contact open-access@uwm.edu.

Second Edition
AN ANNOTATED iTEXT

Cell and Molecular Biology

*What We Know
& How We Found Out*

Gerald Bergtrom

Image Adapted From: [Microarray](#)

Cell and Molecular Biology

What We Know & How We Found Out

2nd edition (CMB 2e)

An *Annotated* Creative Commons (Open Access)
iText

By

Gerald Bergtrom

New in CMB 2e:

- ✓ New format
- ✓ New chapter on repetitive DNA and transposons
- ✓ New chapter on the origins of life
- ✓ Many updates and additional readings, including New or expanded sections on DNA repair, prions, novel RNA, cancer biology and more
- ✓ Two versions + Sample Chapter

To my wife, son and our now extended family whose patience
and encouragement made this work possible, to my mentor
Herbert Oberlander who gave me the chance and the tools
to do science *and*, to my students from whose curiosity
I received as much as I gave

Written, Compiled and Curated Under (*Creative Commons with Attribution*) License and *Fair Use* Rules of Distribution

Creative Commons Licensure and Permissions

The following is a human-readable summary of (and not a substitute for) the *cc-by* 4.0 [license](#).

You are free to:

- **Share** — copy and redistribute the material in any medium or format
- **Adapt** — remix, transform, and build upon the material for any purpose, even commercially. The licensor cannot revoke these freedoms as long as you follow the license terms.

Under the following terms:

- **Attribution** — You must give [appropriate credit](#), provide a link to the license, and [indicate if changes were made](#). You may do so in any reasonable manner, but not in any way that suggests the licensor endorses you or your use.
- **No additional restrictions** — You may not apply legal terms or [technological measures](#) that legally restrict others from doing anything the license permits.

Notices:

- You do not have to comply with the license for elements of the material in the public domain or where your use is permitted by an applicable [exception or limitation](#).
- No warranties are given. The license may not give you all of the permissions necessary for your intended use. For example, other rights such as [publicity, privacy, or moral rights](#) may limit how you use the material.

Citation Information:

2nd Edition, Published 2016



ISBN: 978-0-9961502-1-7

Preface to CMB 2e

Most introductory science courses start with a discussion of scientific method. The 2nd edition of this *interactive Cell & Molecular Biology* electronic textbook, or *iText* is no exception. A key feature of **CMB 2e** is still a focus on experimental support for what we know about cell and molecular biology. A sense of how science is practiced and how investigators think about experimental results is essential to understanding the relationship of cell structure and function, not to mention the rest of the world around us. Rather than trying to be a comprehensive reference book, **CMB 2e** selectively details essential methods and experiments that are the basis of our current understanding of the biochemical and molecular basis of cell structure and function. This focus is nowhere more obvious than in the list of **learning objectives** and in the Voice-Over PowerPoint (**VOP**) presentations provided for each chapter. *Learning objectives* align with chapter content and serve as an aid and guide to learning. They ask students to use new-found knowledge to make connections and demonstrate deeper concept understanding and critical thinking skills. The *VOPs* are freely available on Youtube™ (with optional closed captioning), as are most of the videos linked elsewhere in the *iText*.

There are two versions of **CMB 2e iText** (all versions of the first edition are still available). The **Annotated CMB-2e iText**, contains many embedded *just-in-time* links to external resources including links to animations of cell process, relevant current research summaries, etc. *Challenge* text boxes raise provocative questions about the *iText* content, and may be used to provoke class or online discussion (assessed or not!). A **CMB-2e iText For Instructors** (available on request) includes these features and adds writing assessments that the author has actually assigned for course credit. These appear in the right margin of the text and are **25 Words or Less** writing assignments that aim to strengthen critical thinking and writing skills. Some of these features are modeled in the **CMB 2e Sample Chapter**, such as online discussions and low-stakes formative objective quizzes (note that hyperlinks to assessments in the *Sample* and *Instructor iText* versions require student/instructor login to a course management system and are therefore inactive).

While not comprehensive, this *iText* was written with the goal of creating content that is engaging, free and comparable in quality to very expensive commercial textbooks. To that end, illustrations created especially for the *iText* are supplemented by online open sources (with appropriate attribution). So, whichever CMB 2e version you are use, we encourage instructors to use the interactive features in this *iText* to challenge students. For their part, we encourage students to think about how great experiments were inspired and designed, how alternative experimental results were predicted, how actual data was interpreted, and finally, and what questions the investigators (and we!) might want to ask next. Although the online *iText* is the most efficient way to access links and complete online assignments, students are free to download, read, study, and add your own annotations off-line... or print it out and write in the margins the old fashioned way! Your instructor will undoubtedly provide more detailed instructions for using your *iText*.

Special Note to Instructors from the Author

All features of the **Annotated** version of the CMB 2e *iText* are freely available to you and your students. The **Complete** version of the *iText* is available after filling out a short form identifying you as an instructor. Feel free to add, subtract, modify or embellish any part of any version of the text or interactive content to suit your purposes... and then provide your customized version of the text to your students. Feel free also to ask your students participate in the improvement of the *iText*... for fun or for credit and then..., share the results your efforts with others!

One final bit of advice: where I provide content updates e.g., in links to very current sources, please be aware (and let the students know) that I refer to the content as new, interesting and not necessarily definitive (i.e., it is subject to confirmation). I hope that you (and perhaps your students!) will enjoy creating and customizing interactive elements in the *iText*. Above all, I hope that your students will achieve a better understanding of how scientists use skills of inductive and inferential logic to ask questions and formulate hypotheses..., and to how they apply concept and method to testing those hypotheses.

Acknowledgements

First and foremost, credit for my efforts has to go to the University of Wisconsin-Milwaukee and the 35-plus years of teaching and research experience that inform the content, concept and purpose of this digital *Open Education Resource* (OER). I want to thank my colleagues in the *Center for Excellence in Teaching and Learning* (CETL) and the Golda Meir Library at UW-M for the opportunity and the critical input that led to what I have defined as an *iText* (interactive text). Many thanks to Matthew Russell, Megan Haak, Melissa Davey Castillo, Jessica Hutchings, Dylan Barth for help and the inspiration to suggest at least a few ways to model how open course content can be made interactive and engaging. Thanks also to Tim Gritten and Kristen Woodward for putting competent editorial eyes on the *iText*. Finally special thanks to Tim Gritten for walking me through the intricacies of publication of the *iText* on the UW-M Digital Commons... with uncommon patience!

About the Author

Dr. Bergtrom is Professor (Emeritus) of Biological Sciences and a Learning Technology Consultant (formerly in the Center for Excellence in Teaching and Learning at the University of Wisconsin-Milwaukee. Scientific interests are cell and molecular biology and evolution. Pedagogic interests include blended and online instruction and the use of technology in the service of better teaching and learning. Dedicated to an active learning approach, he has taught face-to-face, blended and so called “flipped” classes, as well as fully online undergraduate and graduate courses in cell and molecular biology. He also developed and co-instructed *Teaching with Technology*, an interdisciplinary course aimed at graduate students that might someday find themselves struggling to teach others. With more than 40 years of experience in teaching and research, he has frequently tested and incorporated pedagogically proven teaching technologies into his courses. In addition to many research publications in cell biology and evolution, he has published on aspects of active blended, online and flipped classroom methods¹⁻³. In 2015 Dr. Bergtrom published ***Cell and Molecular Biology – What We Know & How We Found Out***, an Open Access/Creative Commons (i.e., no-cost) electronic textbook⁴. The updated second edition (***CMB 2e***) of this textbook was published in 2016⁴. Access to the older editions remain available on the UWM Digital Commons website.

1. Bergtrom, G. (2006) *Clicker Sets as Learning Objects*. Int. J. Knowl. & Learn. Obj. 2:105-110. (<http://www.ijello.org/Volume2/v2p105-110Bergtrom.pdf>)
2. Bergtrom, G. (2009) *On Offering a Blended Cell Biology Course*. J. Res. Center Ed. Tech. 5(1) (<http://www.rcetj.org/?type=art&id=91609&>).
3. Bergtrom, G. (2011) *Content vs. Learning: An Old Dichotomy in Science Courses*. J. Asynchr. Learning Networks 15:33-44 (http://jaln_v15n1_bergtrom.pdf)
4. Bergtrom, G. *Cell and Molecular Biology: What We Know & How We Found Out* [CMB1e, (2015) and CMB2e (2016), all versions] (http://dc.uwm.edu/biosci_facbooks_bergtrom/)

Table of Contents

(Click title to see first page of chapter or section.)

[Preface](#)

[Chapter 1: Cell Tour, Life's Properties and Evolution, Studying Cells](#)

[Chapter 2: Basic Chemistry, Organic Chemistry and Biochemistry](#)

[Chapter 3: Details of Protein Structure](#)

[Chapter 4: Bioenergetics](#)

[Chapter 5: Enzyme Catalysis and Kinetics](#)

[Chapter 6: Glycolysis, the Krebs Cycle and the Atkins Diet](#)

[Chapter 7: Electron Transport, Oxidative Phosphorylation and Photosynthesis](#)

[Chapter 8: DNA Structure, Chromosomes, Chromatin, Replication & DNA Repair](#)

[Chapter 9: Repetitive DNA, A Eukaryotic Genomic Phenomenon](#)

[Chapter 10: Transcription and RNA Processing](#)

[Chapter 11: The Genetic Code and Translation](#)

[Chapter 12: Gene Regulation and Epigenetic Inheritance](#)

[Chapter 13: DNA Technologies](#)

[Chapter 14: Membrane Structure](#)

[Chapter 15: Membrane Function](#)

[Chapter 16: The Cytoskeleton and Cell Motility](#)

[Chapter 17: Cell Division and the Cell Cycle](#)

[Chapter 18: The Origins of Life](#)

[List of Videos on YouTube](#)

Chapter 1: Cell Tour, Life's Properties and Evolution, Studying Cells

Scientific Method; Cell structure, methods for studying cells (microscopy, cell fractionation, functional analyses); Common ancestry, genetic variation, evolution, species diversity; cell types & the domains of life



http://4.bp.blogspot.com/_gKeCFUjzm0/Txv2D4ume2I/AAAAAAAAAaA/ICz5Njupghs/s1600/cd8a4fe01ef3012f2fe800163e41d65b.gif/31109bms.jpg

I. Introduction

The first two precepts of Cell Theory were enunciated near the middle of the 19th century, after many observations of plant and animal cells revealed common structural features (e.g., a nucleus, a wall or boundary, a common organization of cells into groups to form multicellular structures of plants and animals and even lower life forms). These precepts are (1) Cells are the basic unit of living things; (2) Cells can have an independent existence. The 3rd statement of cell theory had to wait until late in the century, when Louis Pasteur disproved notions of spontaneous generation, and German histologists observed mitosis and meiosis, the underlying events of cell division in eukaryotes: (3) Cells come from pre-existing cells (i.e., they reproduce)

We begin this chapter with a reminder of the scientific method, a way of thinking about our world that emerged formally in the 17th century. We then take a tour of the cell, reminding ourselves of basic structures and organelles. After the 'tour', we consider the origin of cells from a common ancestor (the *progenote*) and the subsequent evolution of cellular complexity and the incredible diversity of life forms. Finally, we consider some of the methods we use to study cells. Since cells are small, several techniques of microscopy, cell dissection and functional/biochemical analysis are described to illustrate how we come to understand cell function.

Voice-Over PowerPoint Presentations

[Cell Tour Part 1](#)

[Cell Tour Part 2](#)

[Comments on Life's Properties, Origins and Evolution](#)

[Techniques for Studying Cells](#)

Learning Objectives

When you have mastered the information in this chapter and the associated VOPs, you should be able to:

1. compare and contrast *hypotheses* and *theories* and place them and other elements of the scientific enterprise into their place in the cycle of the *scientific method*
2. compare and contrast structures common to and that distinguish *prokaryotes*, *eukaryotes* and *archaea*, and groups within these *domains*
3. articulate the function of different cellular substructures and compare how *prokaryotes* and *eukaryotes* accomplish the same functions, i.e. display the same essential *properties of life*, despite the fact that prokaryotes lack most of the structures
4. outline a procedure to study a specific cell *organelle* or other substructure
5. describe how the different structures (particularly in eukaryotic cells) relate/interact with each other to accomplish specific functions
6. place cellular organelles and other substructures in their evolutionary context, i.e., describe their origins and the selective pressures that led to their *evolution*
7. distinguish between the random nature of *mutation* and *natural selection* in evolution
8. relate archaea to other life forms and engage in informed speculation on their origins in evolution
9. answer the questions “Why does evolution lead to more complex ways of sustaining life when simpler organisms are able to do with less, and are so prolific?” & “Why are *fungi* more like animals than plants?”

II. Scientific Method – The Practice of Science

You can read the link at [Scientific Method – The Practice of Science](#) for a full discussion of this topic. For an amusing look at how scientists think, check out Richard Feynman [(1999) *The Pleasure of Finding Things Out: The Best Short Works of Richard Feynman*. New York, Harper Collins]. Here we focus on the essentials of the method and then look at how science is practiced. As you will see, scientific method refers to a standardized protocol for observing, asking questions about and investigating natural phenomena. Simply put, it says look/listen, infer a cause and test your inference. But observance of the method is not strict and is more often honored in the breach than by adherence to protocol! As captured by the Oxford English Dictionary, the essential inviolable commonality of all scientific practice is that it relies on “systematic observation, measurement, and experiment, and the formulation, testing and modification of hypotheses.”

In the end, scientific method in the actual practice of science recognizes human biases and prejudices and allows deviations from the protocol. At its best, it provides guidance to the investigator to balance personal bias against the leaps of intuition that successful science requires. As followed by most scientists, the practice of scientific method would indeed be considered a success by almost any measure. Science “as a way of knowing” the world around us constantly tests, confirms, rejects and ultimately reveals new knowledge, integrating that knowledge into our world view.

Here are the key elements of the scientific method, in the usual order:

- Observe natural phenomena (includes reading the science and thoughts of others).
- Propose an explanation based on objectivity and reason, an inference, or hypothesis. An hypothesis is a declarative sentence that sounds like a fact... but isn't! Good hypotheses are testable - turn them into *if/then (predictive)* statements or *yes-or-no* questions.
- Design an experiment to test the hypothesis: results must be measurable evidence for or against the hypothesis.
- Perform the experiment and then observe, measure, collect data, and test for statistical validity (where applicable).
- Repeat the experiment.
- Publish! Integrate your experimental results with earlier hypotheses and prior knowledge. Shared data and experimental methods will be evaluated by other scientists. Well-designed experiments are those that can be repeated and results reproduced, verified and extended.

Beyond these most common parts of the scientific method, most descriptions add two more precepts:

- A *Theory* is a statement well-supported by experimental evidence and widely accepted by the scientific community. One of the most enduring, tested theories is of course the theory of evolution. Even though theories are more generally thought of as ‘fact, they are still subject to being tested, and can even be overturned! Even Darwin’s notions have been modified over time, but those modifications have only strengthened our understanding that species diversity is the result of natural selection. You can check out some of Darwin’s own work [Darwin C. (1859, 1860) *The Origin of Species*] at <http://literature.org/authors/darwin-charles/the-origin-of-species/>. For more recent commentary on the evolutionary underpinnings of science, check out Dobzhansky T (1973, *Nothing in biology makes sense except in the light of evolution*. Am. Biol. Teach. 35:125-129) and Gould, SJ (2002, *The Structure of Evolutionary Theory*. Boston, Harvard University Press).

- Scientific Laws are even closer to ‘fact’ than theories! These Laws are thought of as universal and are most common in math and physics. In life sciences, we recognize Mendel’s *Law of Segregation* and *Law of Independent Assortment* as much in his honor as for their universal and enduring explanation of genetic inheritance in living things. But we do not call these Laws *facts*. They are always subject to experimental test. Astrophysicists are actively testing universally accepted laws of physics even Mendel’s *Law of Independent Assortment* should not be called law (strictly speaking) since it is not true as he stated it (go back and see how chromosomal crossing over was found to violate this law!).

In describing how we do science, the Wikipedia entry suggests that the goal of a scientific inquiry is to obtain knowledge in the form of testable explanations (hypotheses) that can predict the results of future experiments. This allows scientists to gain an understanding of reality, and later use that understanding to intervene in its causal mechanisms (such as to cure disease). The better an hypothesis is at making predictions, the more useful it is, and the more likely it is to be correct.

In the last analysis, think of hypotheses as *educated guesses* and think of Theories and/or Laws as one or more experimentally supported hypothesis that everyone agrees should serve as *guideposts* to help us evaluate new observations and hypotheses.

CHALLENGE: Since “An hypothesis is a declarative sentence that sounds like a fact...”, and since both theories and hypotheses are stated as declarative sentences, articulate in your own words the difference between an hypothesis and a theory.

Here is how Wikipedia presents the protocol of the Scientific Method:

The cycle of formulating hypotheses, testing and analyzing the results, and formulating new hypotheses, will resemble the cycle described below:

- *Characterizations: observations, definitions, and measurements of the subject of inquiry*
- *Hypotheses: possible explanations of observations and measurements*
- *Predictions: reasoning by deductive and inferential logic from the hypothesis (note that even widely accepted theories are subject to testing in this way)*
- *Experiments (tests of predictions)*
- *New Characterizations: observations, definitions, and measurements of the subject of inquiry*

A linearized, pragmatic scheme of the five points above is sometimes offered as a guideline for proceeding:

1. Define a question
2. Gather information and resources (observe)
3. Form an explanatory hypothesis
4. Test the hypothesis by performing an experiment and collecting data in a reproducible manner
5. Analyze the data
6. Interpret the data and draw conclusions that serve as a starting point for new hypothesis

...To which we would add the requirement that the work of the scientist be disseminated by publication!

Why did philosophers (not scientists!) come up with systems of deductive and inductive logic so essential to the scientific method? Perhaps because experimental science only became common in the 19th century, when the term *scientist* began to define one who investigated natural phenomena by doing experiments. But long before this, philosophers developed formal rules of logic to try to understand nature, humanity's relationship to nature, and the relationship of humans to each other. The scientific method grew along with increasing empirical observation and experimentation. We recognize these origins when we award the Ph.D. (*Doctor of Philosophy*), our highest academic degree!

III. Domains of Life

We believe with good reason (as you shall see) that all life on earth evolved from the *progenote*, a cell that existed soon after the origin of life on the planet. *Prokaryotes* lack nuclei (*pro* meaning *before* and *karyon* meaning *kernel*, or *nucleus*). Prokaryotic cells, among the first descendants of the *progenote*, fall into two groups, *archaea* and *eubacteria* (including *bacteria* and *cyanobacteria*, or blue-green algae). Prokaryotes were long defined as a major life grouping, alongside *eukaryotes*. But the recent discovery of *archaea* changed all that! Cells that thrive in inhospitable environments like boiling hot springs or arctic ice were the first to be characterized as *archaea*, but now we know that these unusual organisms inhabit more temperate environments. As of 1990, *eubacteria*, *archaea* and *eukaryotes* characterize the *three domains of life*. That all living organisms can be shown to belong to one of these three domains has dramatically changing our understanding of evolution.

A. The Prokaryotes (*eubacteria* = *bacteria* and *cyanobacteria*)

Compared to eukaryotes, prokaryotic cells typically lack a nucleus as well as mitochondria, chloroplasts, internal membranes and other organelles (e.g., endoplasmic reticulum, assorted vesicles and internal membranes). They are typically

unicellular, although a few live colonial lives at least some of the time (e.g., cyanobacteria). Typical rod-shaped bacteria are shown (below left). A schematic diagram of typical bacterial structure is also shown (below right).

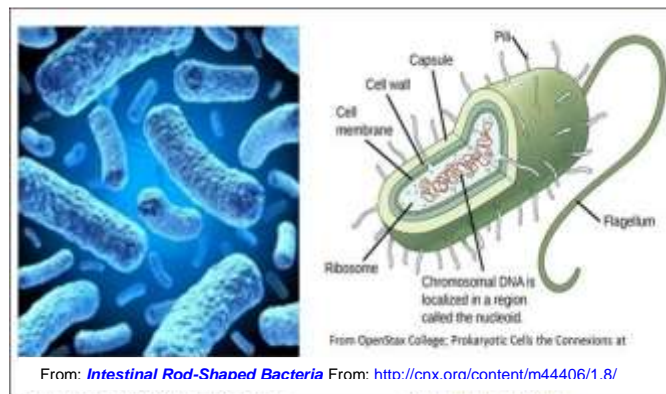

1. Bacterial Reproduction

Without the compartments afforded by the internal membrane systems common to eukaryotic cells, all intracellular events, from DNA replication to transcription and translation to the biochemistry of life all happen in the cytoplasm of the cell. DNA is a circular double helix that duplicates as the cell grows. While not enclosed in a nucleus, bacterial DNA is concentrated in a region of the cell called the *nucleoid*. Bacteria replicate their DNA throughout the life of the cell, ultimately dividing by *binary fission*. The result is the equal partition of duplicated bacterial “chromosomes” into new cells. The bacterial chromosome is essentially naked DNA, unassociated with chromosomal proteins. In contrast, eukaryotic cells divide by mitosis, a time when their DNA is organized into tightly packed chromosomes associated with many different proteins (see below). Just to make life more interesting, we should note that one group of prokaryotes (the *Planctomycetes*) have surrounded their nucleoid DNA with a membrane!

CHALLENGE: How do you imagine these cells would divide their DNA equally between daughter cells during cell division?

2. Cell Motility and the Possibility of a Cytoskeleton

Movement of bacteria is typically by *chemotaxis*, a response to environmental chemicals. They can move to or away from nutrients or noxious/toxic substances. Bacteria exhibit one of several modes of motility. For example, many move using

flagella made up largely of the protein *flagellin*. While the cytoplasm of eukaryotic cells is organized by a cytoskeleton of rods and tubes made of *actin* and *tubulin* proteins, prokaryotes were long thought not to contain cytoskeletal analogs (never mind homologs!). However, two bacterial genes were recently discovered and found to encode proteins homologous to eukaryotic actin and tubulin. The *MreB* protein forms a *cortical ring* in bacteria undergoing *binary fission*, similar to the actin cortical ring that pinches dividing eukaryotic cells during *cytokinesis* (the actual division of a single cell into two smaller daughter cells). This is modeled in the cross-section near the middle of a dividing bacterium, drawn below.



The *FtsZ* gene encodes a homolog of tubulin proteins. Together with flagellin, the MreB and FtsZ proteins may be part of a primitive prokaryotic *cytoskeleton* involved in cell structure and motility.

3. **Some Bacteria have Internal Membranes**

While lacking organelles (the membrane-bound structures in eukaryotic cells), internal membranes that appear to be inward extensions (*invaginations*) of plasma membrane have been known in a few prokaryotes for some time. In some prokaryotic species and groups, these membranes perform capture energy from sunlight (photosynthesis) or from inorganic molecules (*chemolithotrophy*). *Carboxysomes*, membrane bound photosynthetic vesicles in which CO₂ is actually fixed (reduced) in cyanobacteria (shown below).

From: http://en.wikipedia.org/wiki/File:Carboxysomes_EM.jpg



Less elaborate internal membrane systems are found in photosynthetic bacteria.

4. ***Bacterial Ribosomes do the Same Thing as Eukaryotic Ribosomes... and look like them!***

Ribosomes are the protein synthesizing machines of life. The *ribosomes* of prokaryotes are smaller than those of eukaryotes, but *in vitro* they can be made to translate eukaryotic messenger RNA (mRNA). Underlying this common basic function is the fact that the ribosomal RNAs of all species share base sequence and structural similarities indicating an evolutionary relationship. It was these similarities that revealed the closer relationship of archaea to eukaryotes than prokaryotes.

Clearly, prokaryotes are a diverse group of organisms, occupying almost every wet or dry or hot or cold nook and cranny of our planet. But despite of this diversity, all prokaryotic cells share many structural and functional metabolic properties with each other... and with the archaea and eukaryotes! As we have seen with ribosomes, shared structural and functional properties support the common ancestry of all life. Finally, we not only share common ancestry with prokaryotes, we even share living arrangements with them. Our gut bacteria represent up to 10X more cells than our own! Read more at [The NIH Human Microbiome Project](#). Also check out the following link for [A Relationship Between Microbiomes, Diet and Disease](#).

B. The Archaeobacteria (Archaea)

Allessandro Volta, a physicist for whom the Volt is named, discovered methane producing bacteria (*methanogens*) way back in 1776! He found them living in the extreme environment at the bottom of Lago Maggiore, a lake shared by Italy and Switzerland. These unusual bacteria are *cheomoautotrophs* that get energy from H₂ and CO₂ and generate methane gas in the process. It was not until the 1960s that Thomas Brock (from the University of Wisconsin-Madison) discovered *thermophilic* bacteria living at temperatures approaching 100°C in Yellowstone National Park in Wyoming. The nickname *extremophiles* was soon applied to describe organisms living in any extreme environment. One of the thermophilic bacteria, now called *Thermus aquaticus*, became the source of *Taq* polymerase, the heat-stable DNA polymerase that made the *polymerase chain reaction* (PCR) a household name in labs around the world!

Extremophile and “normal” bacteria both lack nuclei are similar in size and shape(s), which initially suggested that they were closely related to bacteria and were therefore prokaryotes (see the electron micrograph of *Methanosarcina* and *Pyrolobus*, below). But Carl Woese [Woese CR (2004) *A new biology for a new century*. Microbiol. Mol. Biol. Rev. 68:173-186] compared the sequences of genes for ribosomal RNAs in normal bacteria and an increasing number of extremophiles, including the methanogens. Based on sequence similarities and differences, the extremophiles seemed to form a separate group from the rest of the bacteria as well as from

eukaryotes. They were named *archaebacteria*, or *archaea* because these organisms were thought to have evolved even before bacteria.

Woese concluded that *Archaea* were a separate group, or *domain* of life from bacteria and eukaryotes profoundly changing our understanding of phylogenetic relationships. The three domains of life (Archaea, Eubacteria and Eukarya) quickly supplanted the older division of living things into *Five Kingdoms* (*Monera*, *Protista*, *Fungi*, *Plants*, and *Animals*). Another big surprise from rRNA gene sequence comparisons was that the archaea were more closely related to eukaryotes than bacteria! The evolution of the three domains is illustrated below.

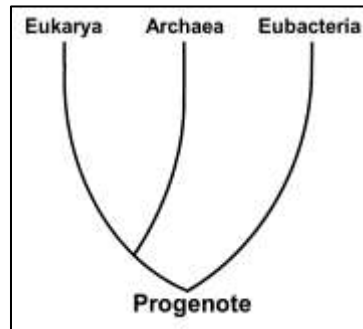

Archaea contain genes and proteins as well as metabolic pathways found in eukaryotes but not in bacteria, speaking to their closer evolutionary relationship to eukaryotes. They also contain genes and proteins as well as metabolic pathways unique to the group, testimony to their domain status.

While some bacteria and eukaryotes can live in extreme environments, the archaea include the most diverse extremophiles:

- Acidophiles: grow at acidic (low) pH.
- Alkaliphiles: grow at high pH.
- Halophiles: require high salt concentrations of salt for growth; *Halobacterium salinarium* is shown below (at the left).

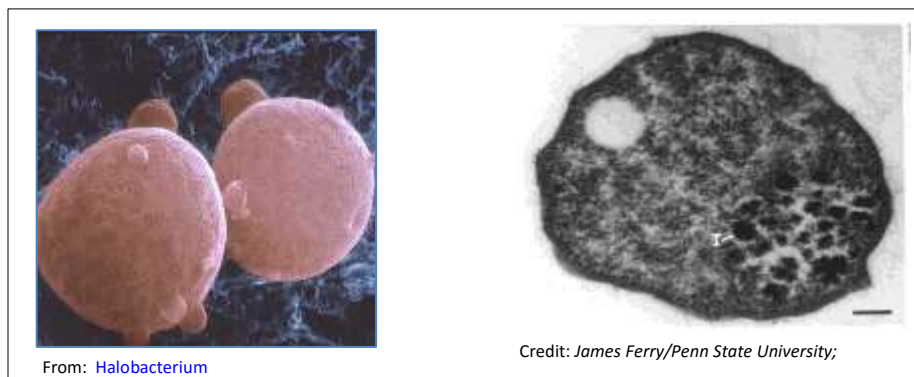

- Methanogens: produce methane; a cross section of *Methanosarcina acetivorans* is shown, above right. Note the absence of significant internal structure.
- Barophiles: grow best at high hydrostatic pressure.
- Psychrophiles: grow best at temperature 15 °C or lower.
- Xerophiles: growth at very low water activity (i.e., drought conditions).
- Thermophiles/hyperthermophiles: organisms that grow best at 40 °C or higher, or 80°C or higher, respectively. *Pyrolobus fumarii*, shown below, can live at a temperature 113°C.



- Toxicolerants: grow in the presence of high levels of damaging elements (e.g., pools of benzene, nuclear waste).

Finally, the Archaea are not only extremophiles thriving in unfriendly environments. They include organisms living in more moderate places including soils, oceans and marshes... and even in the human colon. In oceans, they are a major part of plankton. Originally seen as a sideshow among living things, Archaea are particularly abundant in the oceans where they are a major part of plankton, participating in the carbon and nitrogen cycles. In the guts of cows, humans and other mammals, methanogens facilitate digestion, generating methane gas in the process. Cows have even been cited as a major cause of global warming because of their prodigious methane emissions. Methanogenic Archaea are being exploited to create biogas and to treat sewage, while some extremophiles are the source of enzymes that function at high temperatures or in organic solvents. As noted above, some of these have become part of the biotechnology toolbox.

C. The Eukaryotes

1. Large Compartmentalized Cells

The volume of a typical eukaryotic cell is 1000 times that of a typical bacterial cell. Eukaryotic life would not even have been possible if not for a division of labor of eukaryotic cells among different *organelles* (membrane-bound structures). Imagine a bacterium as a 100 square foot room with one door (the size of a small bedroom,

or a large walk-in closet!). Now imagine a room 1000 times as big. That is, imagine a 100,000 square foot 'room'. Not only would you expect multiple entry and exit doors in the eukaryotic cell membrane, but you would expect lots of interior "rooms" with their own entry ways and exits, to make more efficient use of this large space. The smaller prokaryotic "room" has a much larger *surface area/volume ratio* than a typical eukaryotic "room", enabling necessary environmental chemicals to enter and quickly diffuse throughout the cytoplasm of the bacterial cell. The chemical communication between parts of a small cell is rapid, while communication within eukaryotic cells over a larger expanse of cytoplasm requires the coordinated activities of subcellular components and might be expected to be slower. In fact, eukaryotic cells have lower rates of metabolism, growth and reproduction than do prokaryotic cells. The existence of large cells must therefore have involved an evolution of a *division of labor* supported by *compartmentalization*. Since prokaryotes were the first organisms on the planet, some must have evolved or acquired membrane-bound organelles.

2. Animal and Plant cell Structure Overview

Eukaryotic cells and organisms are diverse in form but similar in function, sharing many biochemical features with each other and as we already noted, with prokaryotes. Typical animal and plant cells showing their organelles and other structures are illustrated below (left and right, respectively):

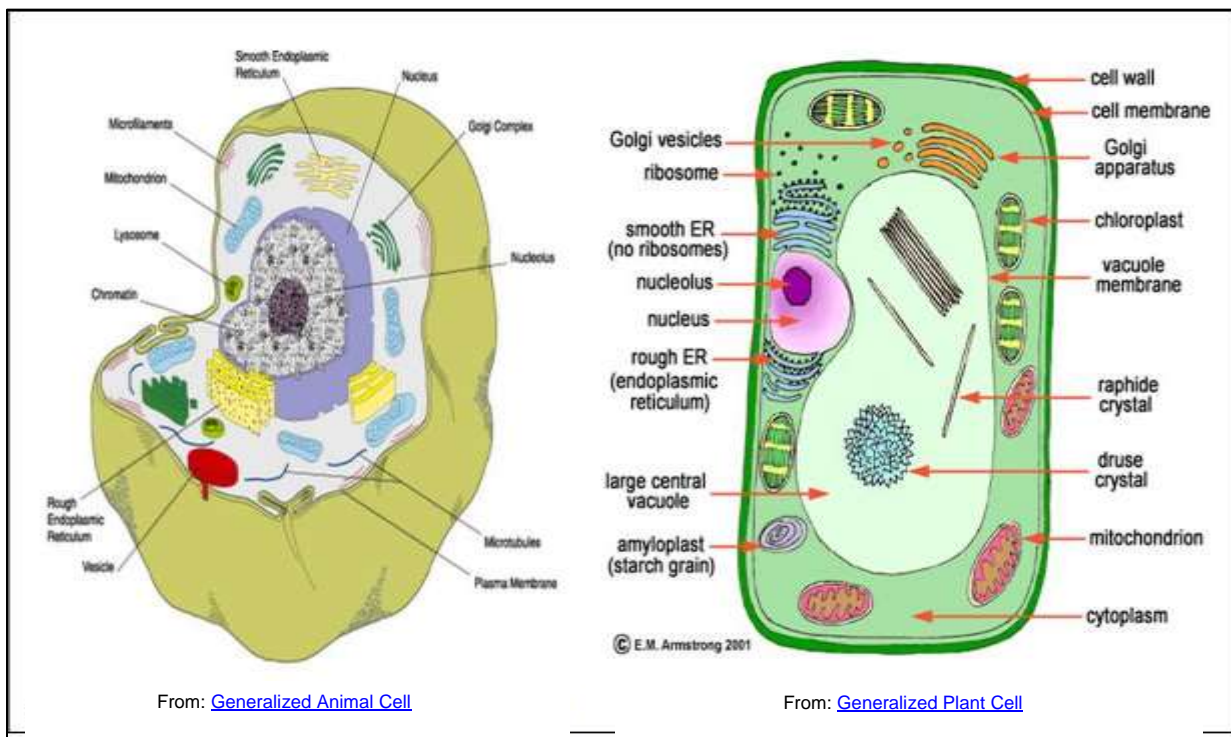

Most of the internal structures and organelles of animal cells are also found in plant cells, where they perform the same or similar functions. We begin a consideration of the function of cellular structures and organelles with a brief description of the function of some of these structures and organelles.

Fungi are actually more closely related to animal than plant cells, and contain some unique cellular structures. While fungal cells contain a wall, it is made of chitin rather than cellulose. Chitin is the same material that makes up the exoskeleton or arthropods (including insects and lobsters!). The organization of fungi and fungal cells is somewhat less defined than animal cells. Structures between cells called *septa* separate fungal hyphae, allowing passage of cytoplasm and even organelles between cells. There are even primitive fungi with few or no septa, in effect creating *coenocytes* that are a single giant cell with multiple nuclei. As for flagella, they are found only in the most primitive group of fungi.

We end this look at the domains of life by noting that, while eukaryotes are a tiny minority of all living species, “their collective worldwide biomass is estimated at about equal to that of prokaryotes” (Wikipedia). On the other hand, our bodies contain 10 times as many microbial cells as human cells! In fact, it is becoming increasingly clear that a human owes as much to its being to its microbiota (see above) as it does to its human cells.

IV. Tour of the Eukaryotic Cell

A. Ribosomes

As noted, these are the protein synthesizing machines in the cell. They are an evolutionarily conserved structure found in all cells, consisting of two subunits, each made up of multiple proteins and one or more molecules of ribosomal RNA (rRNA). Ribosomes bind to messenger RNA (mRNA) molecules and then move along the mRNA, translating 3-base code-words (codons) and using the information to link amino acids into polypeptides. The illustration below shows a ‘string’ group of ribosomes, called a ***polyribosome*** or ***polysome*** for short.

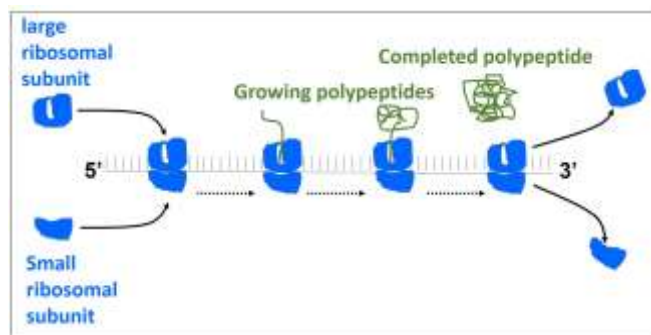

The ribosomes are each moving along the same mRNA simultaneously translating the protein encoded by the mRNA. The granular appearance of cytoplasm in electron micrographs is largely due to the ubiquitous distribution of ribosomal subunits and polysomes in cells. In the electron micrographs of leaf cells from a quiescent and an active desert plant (*Selaginella lepidophylla*), you can make out randomly distributed ribosomes/ribosomal subunits and polysomes consisting of more organized strings of ribosomes (arrows, below left and right respectively).

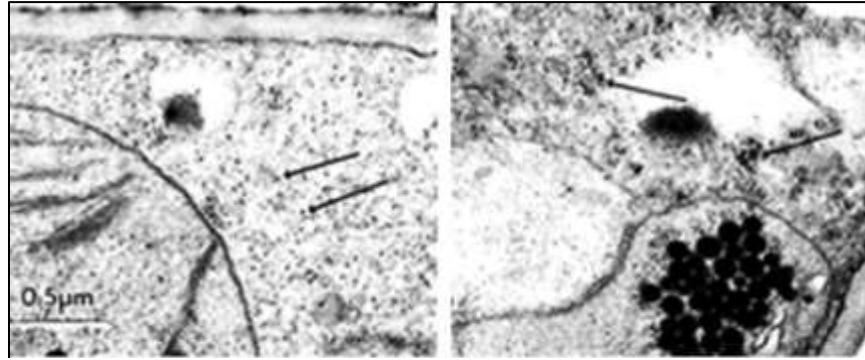

From Bergtrom et al. (1982) J. Ultrastr. Res. 78:269-282

Eukaryotic and prokaryotic ribosomes differ in the number of RNA and proteins in their large and small subunits, and thus in their overall size. When isolated and centrifuged in a sucrose density gradient, they move at a rate based on their size (or more specifically, their *mass*). Their position in the gradient is represented by an “S” value (after *Svedborg*, who first used these gradients to separate particles and macromolecules by mass). The illustration below shows the difference in ribosomal ‘size’, their protein composition and the number and sizes of their ribosomal RNAs.

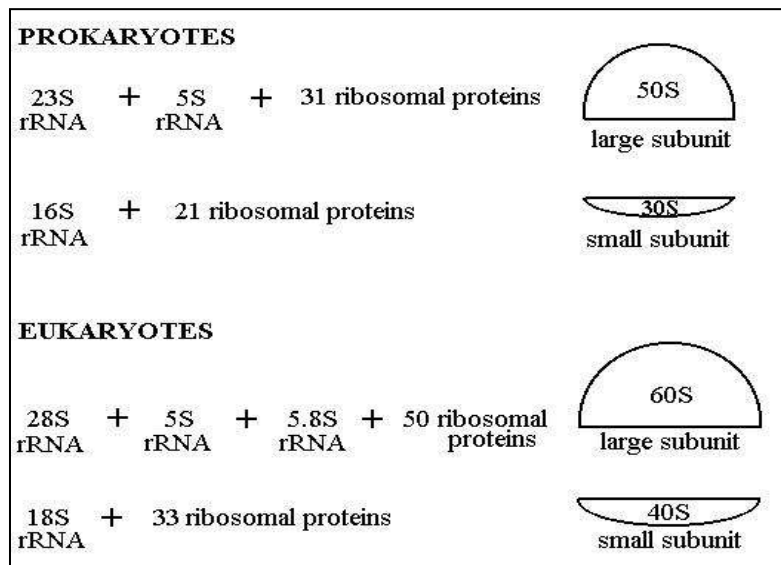

B. Internal membranes and the Endomembrane System

Many of the *vesicles* and *vacuoles* in cells are part of an *endomembrane system*, or are produced by it. The endomembrane system participates in synthesizing and packaging proteins dedicated to specific uses into organelles. Proteins synthesized on the ribosomes of the rough endoplasmic reticulum and the outer nuclear envelope membrane will enter the interior space or lumen, or become part of the RER membrane itself. Proteins incorporated into the RER bud off into *transport vesicles* that then fuse with *Golgi bodies*. See some Golgi bodies (G) in the electron micrograph below.

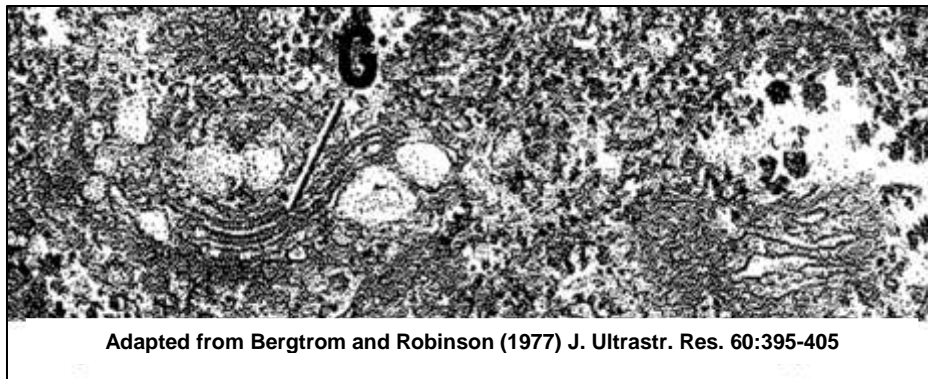

Packaged proteins move through the endomembrane system where they undergo different maturation steps before becoming biologically active, as illustrated below.

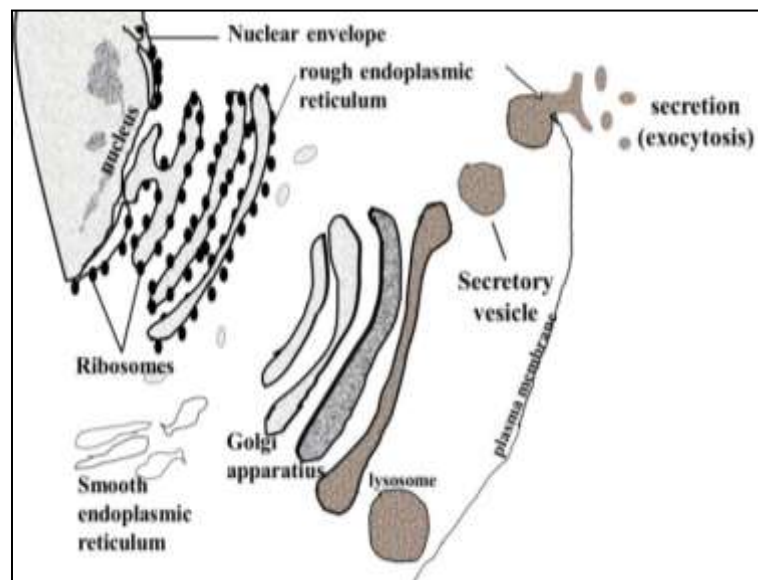

Some proteins produced in the endomembrane system are secreted by *exocytosis*. Others end up in organelles like *lysosomes*. Lysosomes contain enzymes that break down the contents of *food vacuoles* that form by endocytosis. *Microbodies* are a class of vesicles smaller than lysosomes, but formed by a similar process. Among them are *peroxisomes* that break down toxic peroxides formed as a by-product of cellular biochemistry.

The *contractile vacuoles* of freshwater protozoa expel excess water that enters cells by *osmosis*; *extrusomes* in some protozoa release chemicals or structures that deter predators or enable prey capture. In higher plants, most of a cell's volume is taken up by a central vacuole, which primarily maintains its osmotic pressure. These and other vesicles include some that do not originate in the endomembrane pathway, but are formed when cells ingest food or other substances by the process of *endocytosis*. Endocytosis occurs when the outer membrane *invaginates* and then pinches off to form a vesicle containing extracellular material.

C. Nucleus

The nucleus is surrounded by a double membrane (commonly referred to as a *nuclear envelope*), with *pores* that allow material to move in and out. As noted, the outer membrane of the nuclear envelope is continuous with the *RER* (rough endoplasmic reticulum), so that the lumen of the RER is continuous with the space between the inner and outer nuclear membranes. The electron micrograph of the nucleus below has a prominent *nucleolus* (labeled n) and is surrounded by RER.

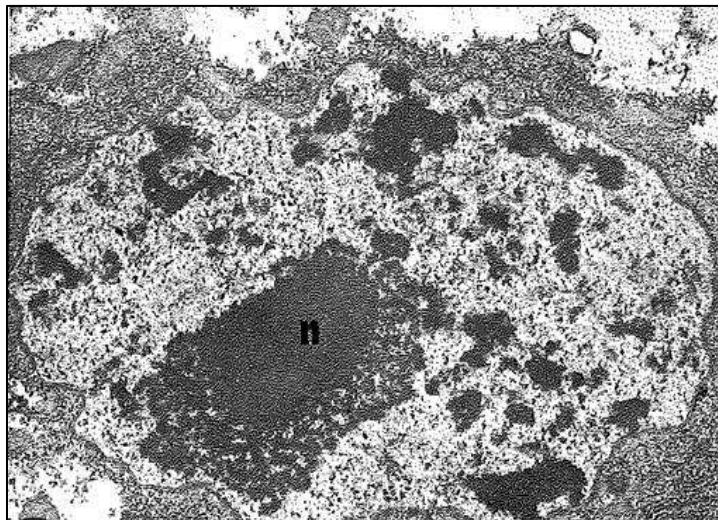

From Bergtrom et al. (1977) J. Ultrastr. Res. 60:395-405

You can almost see the double membrane of the nuclear envelope in this image. Perhaps you can also make out the ribosomes looking like grains bound to the RER as well as to the outer membrane of the nucleus. The nucleus of eukaryotic cells separates the DNA and its associated protein from the cell cytoplasm, and is where the status of genes (and therefore of the proteins produced in the cell) is regulated. Most of the more familiar RNAs (rRNA, tRNA, mRNA) are transcribed from these genes and processed in the nucleus, and eventually exported to the cytoplasm through *nuclear pores* (not visible in this micrograph). Other RNAs function in the nucleus itself, typically participating in the regulation of gene activity. You may recall that when chromosomes form in the run-up to mitosis or meiosis, the nuclear envelope and nucleus disappear, eventually reappearing in the new daughter cells. These events mark the major difference between cell division in bacteria and eukaryotes.

In both, dividing cells must produce and partition copies of their genetic material equally between the new daughter cells. As already noted, bacteria duplicate and partition their naked DNA chromosomes at the same time during growth and binary fission. Growing eukaryotic cells experience a *cell cycle*, within which duplication of the genetic material (DNA replication) is completed well before cell division. The DNA is associated with proteins as *chromatin* during most of the cell cycle. As the time of cell division approaches, chromatin associates with even more proteins to form *chromosomes*.

Every cell contains pairs of *homologous chromosomes*, both of which must be duplicated. In *mitosis*, the chromosomes are pulled apart by the microtubules of the spindle apparatus (green fluorescence in the micrograph below).

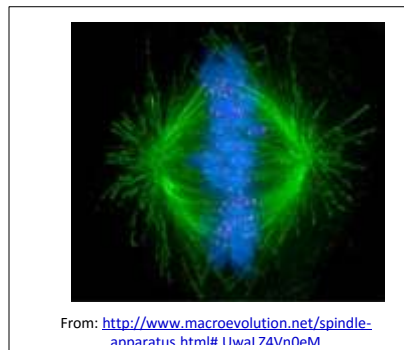

Cytokinesis, the division of one cell into two, begins near the end of mitosis. *Sexual reproduction*, a key characteristic of eukaryotes, involves meiosis rather than mitosis. The mechanism of *meiosis*, the division of *germ cells* leading to production of sperm and eggs, is similar to mitosis except that the ultimate daughter cells have just one each of the parental chromosomes, eventually to become the gametes. These aspects of cellular life are discussed in more detail elsewhere.

D. Mitochondria and Plastids

Nearly all eukaryotic cells contain *mitochondria*, seen in the electron micrograph below.

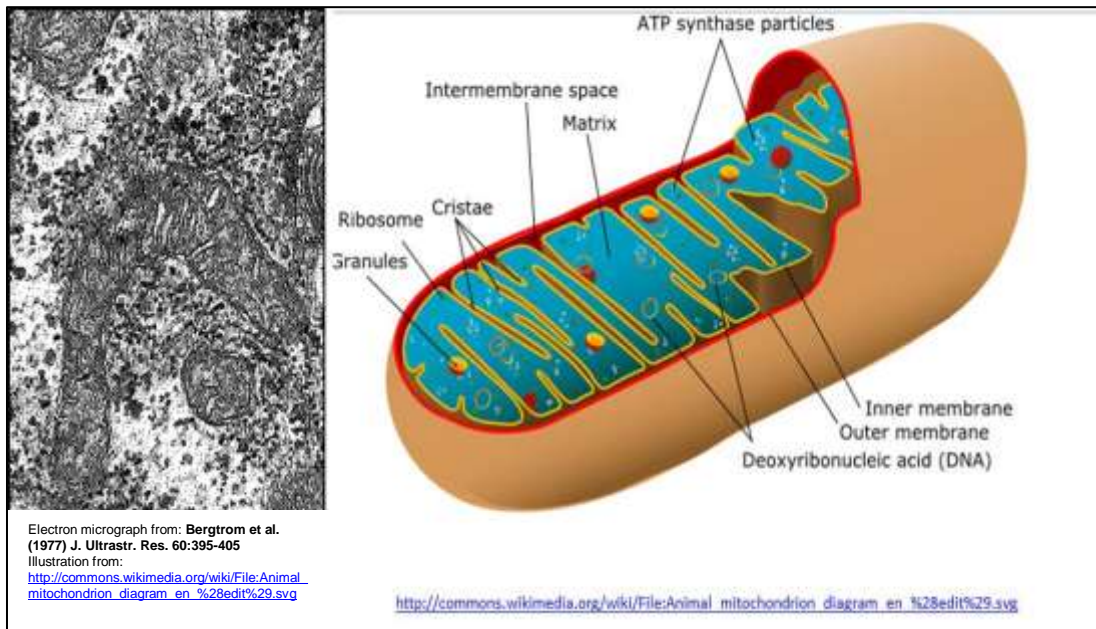

These organelles are surrounded by a double membrane and contain (and replicate) their own DNA, with genes for some mitochondrial proteins. In the illustration above, note that the surface area of the inner membrane is increased by being folded into *cristae*, the site of *cellular respiration* (the oxidation of nutrients in aerobic organisms).

Mitochondria most likely evolved from aerobic bacteria (or protobacteria) engulfed by an early eukaryotic cell that later survived to become *endosymbionts* in the cell cytoplasm. The Endosymbiotic Theory was first proposed by Lynn Margulis [*Sagan, L (1967) On the origin of mitosing cells. Journal of Theoretical Biology* **14** (3): 225–274. (available at: [Margulis L. Endosymbiotic theory](#))]. She also proposed an endosymbiotic origin of chloroplasts (see below).

The few protozoa that lack mitochondria have been found to contain mitochondrion-derived organelles, such as *hydrogenosomes* and *mitosomes*; and thus probably lost the mitochondria secondarily. Like mitochondria, the plastids of plants and some algae have their own DNA and evolved from cyanobacteria that were engulfed by primitive eukaryotic cells. These endosymbionts became chloroplasts and other plastids.

Chloroplasts (illustrated below) and cyanobacteria contain chlorophyll and use a similar photosynthetic mechanism to make glucose.

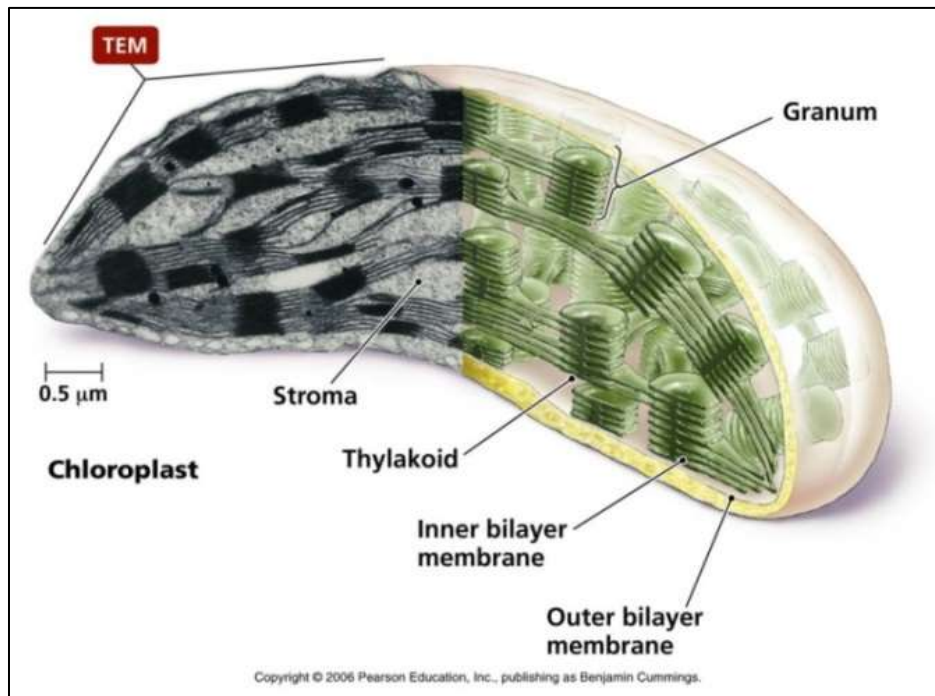

Others plastids develop from chloroplasts to store food; an example is the leucoplast shown below (S is a starch granule). You can see that as a result of starch accumulation, the grana have become dispersed.

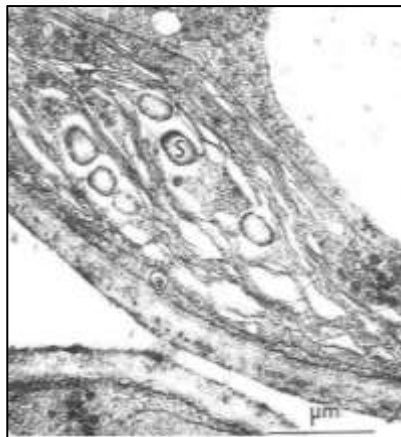

From Bergtrom et al., J. Ultrastr. Res. 78:269-282

E. Cytoskeletal structures

We have come to understand that the cytoplasm of a eukaryotic cell is highly structured, permeated by rods and tubules. The three main components of this cytoskeleton are *microfilaments*, *intermediate filaments* and *microtubules*, with structures illustrated below.

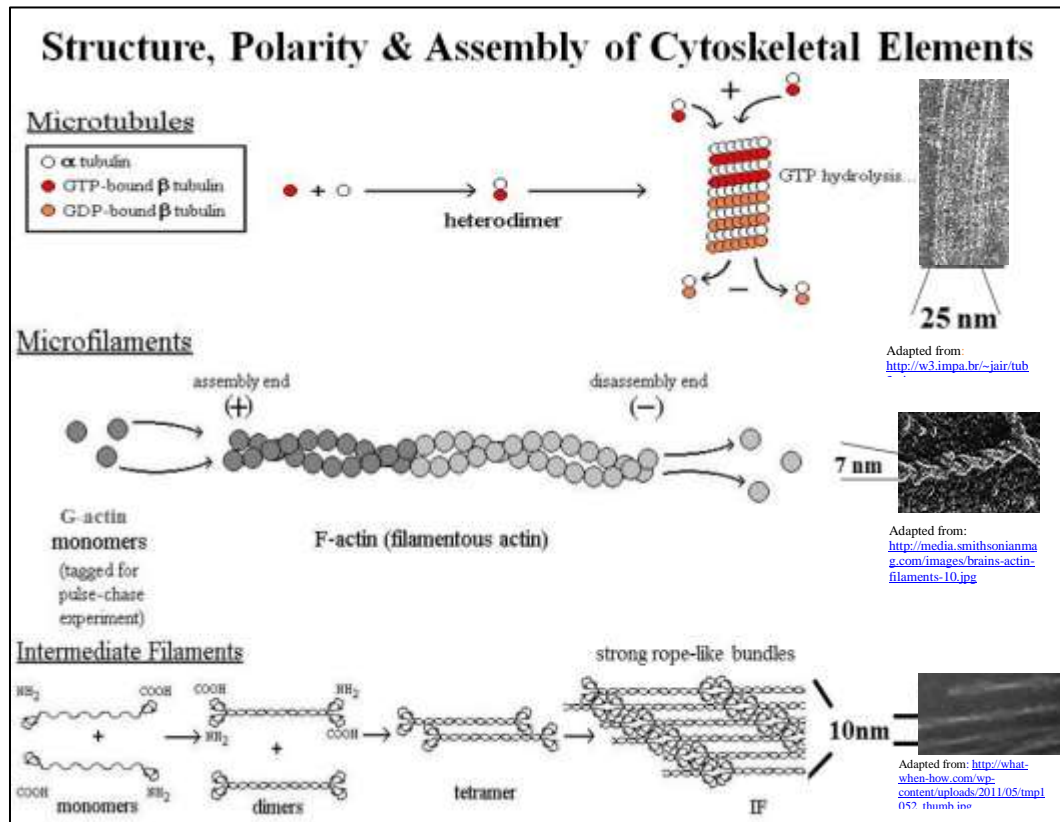

Microfilaments are made up of *actin* monomer proteins. Intermediate filament proteins are related to *keratin*, the same protein found in hair, fingernails, bird feathers, etc. Microtubules are composed of α - and β -*tubulin* proteins. Cytoskeletal rods and tubules not only determine *cell shape*, but also play a role in *cell motility*. This includes the movement of cells from place to place and the movement of structures within cells. We've already noted that a prokaryotic cytoskeleton exists that is in part composed of proteins homologous to actins and tubulins that are expected to play a role in maintaining or changing cell shape. Movement powered by a bacterial flagellum relies on other proteins, notably flagellin (above). Bacterial flagellum structures are actually attached to a molecular motor in the cell membrane that spins a more or less rigid

flagellum to propel the bacterium through a liquid medium. Instead of a molecular motor, eukaryotic *microtubules slide* past one another causing the flagellum to undulate in wave-like motions. The motion of eukaryotic cilia (there is no counterpart structure in prokaryote) is also based on sliding microtubules, in this case causing the cilia to beat rather than undulate. Cilia are involved not only in motility, but in feeding and sensation.

Despite the difference in motion, microtubules in eukaryotic flagella and cilia arise from a basal body (also called a kinetosome or centriole). In the axoneme inside a flagellum or cilium, the microtubules are seen in cross-section to be characteristically arranged as nine doublets surrounding two singlets (see the axoneme below).

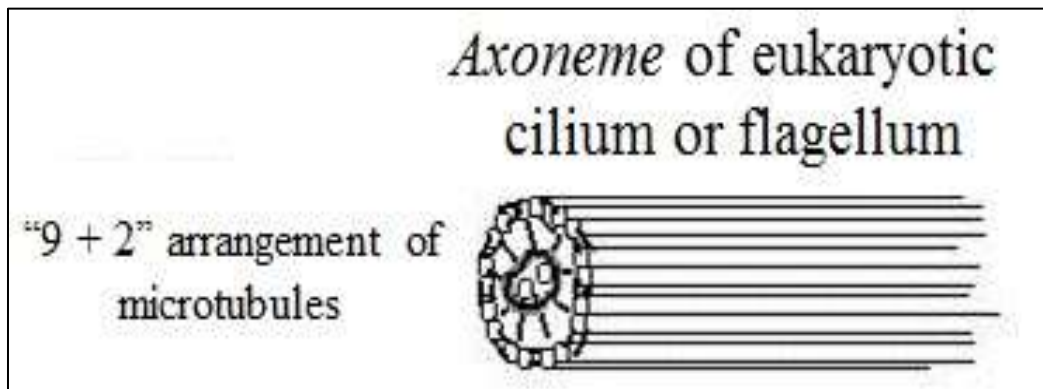

Centrioles are often present in animal cells, and participate in spindle fiber formation during mitosis. They are also the point from which microtubules radiate through the cell to help form and maintain its shape. These structures are themselves comprised of a ring of microtubules. The spindle apparatus in plant cells, which typically lack centrioles, form from an amorphous structure called the *MTOC*, or *MicroTubule Organizing Center*, which serves the same purpose as centrioles in animal cells.

Elsewhere, you will see how microfilaments and microtubules interact with motor (*dynein*, *kinesin*, *myosin*...) and other proteins to generate force that results in the sliding of filaments and tubules to allow cellular movement. You will also see that motor proteins can carry cargo molecules from one place to another in a cell.

F. Cell wall

We noted that plant (also algal) and fungal cells are surrounded by a rigid cell wall, that creates a rigid structure outside the cell membrane supporting cell shape. The cell wall also prevents cells from swelling too much when water enters the cell. The major polysaccharides of the plant cell wall are cellulose, hemicellulose, and pectin, while the principal fungal cell wall component is *chitin*.

V. How We Know about Organelle Function

A. Cell Fractionation

We could see and describe cell parts in the light or electron microscope, but we could not definitively know their function until it became possible to release them from cells and separate them from one another. This became possible with the advent of differential centrifugation, a cell fractionation technique that separates sub-cellular structures by differences in their mass. Cell fractionation (illustrated below) and biochemical analysis of the isolated cell fractions were combined to reveal what different organelles do.

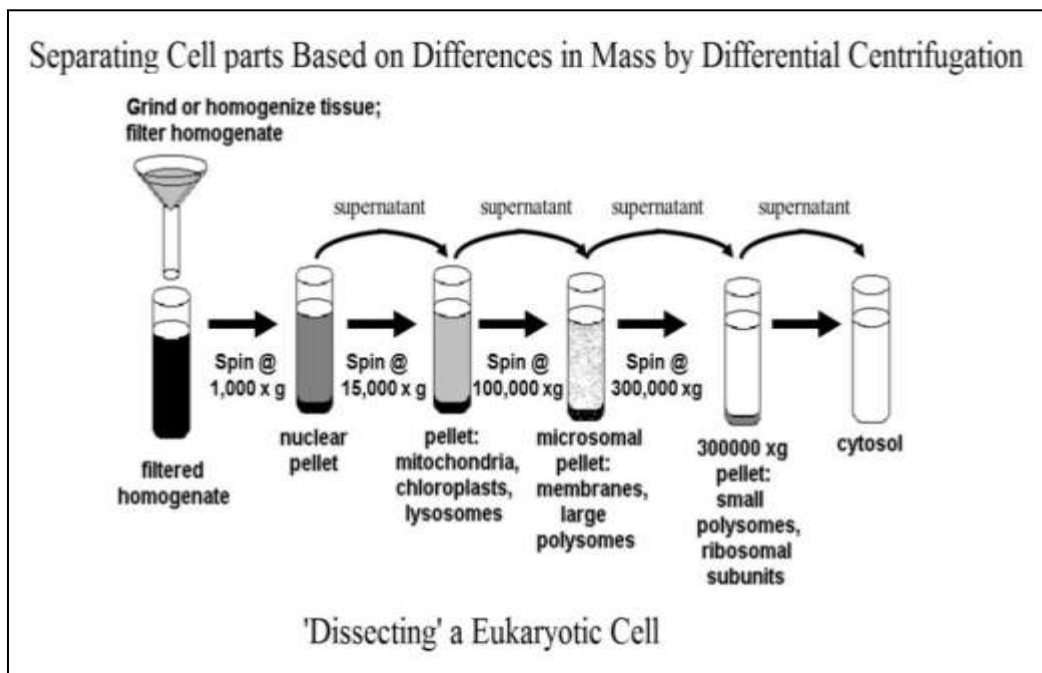

Cell fractionation is a combination of various methods used to separate a cell organelles and components. There are two phases of cell fractionation: homogenization and centrifugation.

1. *Homogenization* is the process of breaking cells open. Cells are broken apart by physical means (such as grinding in a mortar and pestle, tissue grinder or similar device), or treatment with chemicals, enzymes, or sound waves. Some scientists even force the cells through small spaces at high pressure to break them apart.
2. *Centrifugation* is the isolation of the cell organelles based on their different masses. Therefore at the end of this process, a researcher has isolated the mitochondria, the nucleus, the chloroplast, etc.

Scientists use cell fractionation to increase their knowledge of organelle functions. To be able to do so they isolate organelles into pure groups. For example, different cell fractions end up in the bottom of the centrifuge tubes. After re-suspension, the pellet contents can be prepared for electron microscopy. Below are electron micrographs of several such fractions.

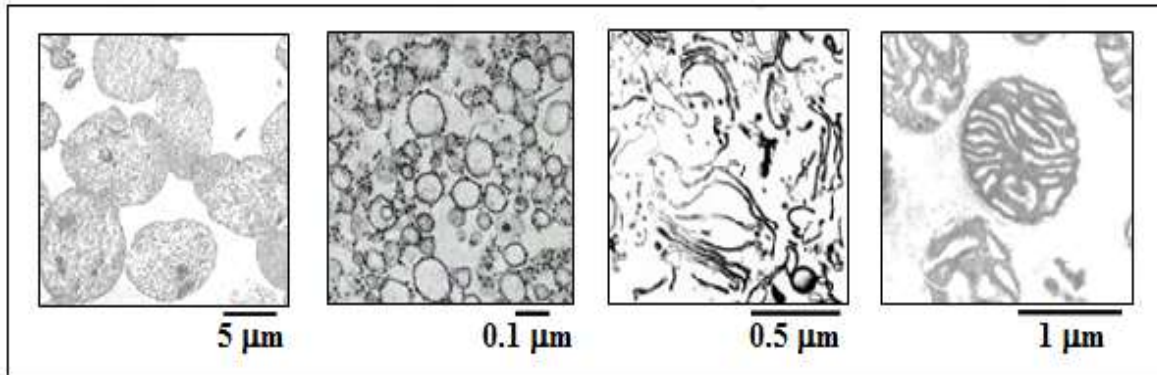

From: openi.nlm.nih.gov

From: [Isolated RER](#)

From: [Isolated Golgi](#)

From: [Isolated Mitochondria](#)

The structures can be identified based (at least tentatively) based on the dimensions and appearance of these structures. Can you tell what organelles have been purified in each of these fractions? The functions of sub-cellular structures isolated in this fashion were worked out by investigating their contents and testing them for function. As an example, the structures on the left were found in a low speed centrifugal pellet, implying that they are large structures. They look a bit like nuclei, which are in fact the largest structures in a eukaryotic cell. If you wanted to be sure, what biochemical or functional test might you do to confirm that the structures in the left panel were indeed nuclei? This method has already resulted in our understanding not only of the identity of subcellular structures, but of previously un-noticed functions of many if not all cell organelles.

For a detailed description of the biochemical analysis, review your instructors VOP and/or un-narrated presentation on cell fractionation. This course is devoted to understanding cell structure and function and how prokaryotic and eukaryotic cells (and organisms) use their common biochemical inheritance to meet very different survival strategies. As you progress in the course, you will encounter one of the recurring themes involving the *dissection* of cells. Look for this theme, involving the *isolation* and *analysis of function* of the cell components, and where possible, the re-assembly (*reconstitution*) of cellular structures and systems. Look also for another theme, namely how evolution can account for the biochemical and genetic of life..., and its structural diversity.

V. Evolution, Speciation and the Diversity of Life

Natural selection was Charles Darwin's theory for how evolution led to the *structural* diversity of species. New species arise when beneficial traits are naturally selected from genetically different individuals in a population, with the concomitant culling of less fit individuals from populations over time. If natural selection acts on individuals, evolution results from the persistence and spread of selected, heritable changes through successive generations in a population. Evolution is reflected as **an increase in diversity and complexity** at all levels of biological organization, from species to individual organisms to molecules like DNA and proteins. For an easy read about the evolution of eyes (whose very existence according to creationists could only have formed by intelligent design by a creator), see the article in National Geographic by E. Yong (Feb., 2016, with its beautiful photography by D. Littschwager).

We say that life on earth originated and then evolved from the **progenote** some 3.7-4.1 billion years ago. But the progenote may have been only one of many experimental cells formed when conditions on earth were permissive to origins of life. **Evolution** began with these first cells; by definition, all cells had all of the properties of life. Therefore, the descendants of "first cells" with their separate origins, would have found different genetic and biochemical solutions to achieving and maintaining life's properties. But all cells and organisms alive today also share the same genetics and biochemistries, suggesting that all life forms other than the progenote never gained a foothold on the planet. At the same time, the descendants of the progenote were evolving, diversifying and generating new species. Since, it is possible that many lineages of its progeny (species) also went extinct..., except for one, which we now call the last Universal Common Ancestor, or LUCA. Repeated speciation, the continual divergence of life forms from this LUCA through natural selection and evolution, is supported by the shared cellular structures, nucleic acid, protein and metabolic chemistries (the 'unity' of life). Since the revolution in molecular biology, shared gene and other DNA sequences have confirmed the shared common ancestry of diverse organisms across all three of life's domains.

These relationships largely confirm what we have learned from the species represented in the fossil record. Morphological, biochemical and genetic traits that are shared across species are defined as *homologous*, and can be used to reconstruct evolutionary histories. The biodiversity that scientists (and environmentalists in particular) try to protect has resulted from millions of years of speciation and extinction. It needs protection from the unwanted evolutionary acceleration from human activities, including blatant extinctions (think passenger pigeon), near extinction (think American bison by the late 1800s), the introduction of invasive aquatic and terrestrial species, and the effects of climate change.

Let's take a closer look at the biochemical and genetic unity among living things. Albert Kluver first recognized that cells and organisms vary in form appearance in spite of the essential biochemical unity of all organisms (http://en.wikipedia.org/wiki/Albert_Kluver).

We've already considered some of the consequences cells getting larger in evolution when we tried to explain how larger cells divided their labors among smaller intracellular structure (organelles). When eukaryotic cells evolved into multicellular organisms, it became necessary for the different cells to communicate with each other and to respond to environmental cues. Some cells evolved mechanisms to "talk" directly to adjacent cells and others evolved to transmit electrical (neural) signals to other cells and tissues. Still other cells produced hormones to communicate with cells to which they had no physical attachment. As species diversified to live in very different habitats, they also evolved very different nutritional requirements, along with more extensive and elaborate biochemical pathways to digest their nutrients and capture their chemical energy. Nevertheless, Kluver and many others eventually recognized that despite billions of years of obvious evolution and astonishing diversification, the underlying genetics and biochemistry of living things on this planet is remarkably unchanged. This unity amidst the diversity of life is an apparent paradox of life that we will probe in this course.

A. Genetic Variation, the Basis of Natural Selection

DNA contains the genetic instructions for the structure and function of cells and organisms. When and where a cell or organism's genetic instructions are used (i.e., to make RNA and proteins) is regulated. Genetic variation results from random mutations. Genetic diversity arising from mutations is in turn, the basis of natural selection during evolution.

B. The Genome: an organisms complete genetic instructions

The genome of an organism is the entirety of its genetic material (DNA, or for some viruses, RNA). The genome of a common experimental strain of *E. coli* was sequenced by 1997. For details, see Blattner FR et al. (1997) *The complete genome sequence of Escherichia coli K-12*. Science 277:1452-1474. That of humans was completed by 2001, well ahead of the predicted schedule! For more details, see Venter JC (2001) *The sequence of the human genome*. Science 291:1304-1351. Through mutation, genomes exhibit genetic variation, not only between species, but between individuals of the same species.

C. Genomic 'Fossils' Can Confirm Evolutionary relationships.

It has been known for some time that gene and protein sequencing can reveal evolutionary relationships and even familial relationships. Read about an early demonstration of such relationships based on amino acid sequence comparisons across evolutionary time in Zuckerkandl E and Pauling L. (1965) *Molecules as documents of evolutionary theory*. J. Theor. Biol. 8:357-366. It is now possible to extract DNA from fossil bones and teeth, allowing comparisons of extant, ancient and

even extinct species. Thus, DNA has been extracted from the fossil remains of humans, other hominids, and many animals. Sequencing this DNA (see the chapter on DNA Technologies) has revealed our relationship to some of our hominid ancestors and some of these ancient species. The reality though, is that DNA from organisms much older than 10,000 years is typically so damaged or simply absent that relationship building beyond that time is not possible. Now in a clever twist, using what we know of extant gene sequences, investigators recently '*constructed*' a genetic phylogeny suggesting the sequences of some of our long-gone progenitors, including bacteria (click here to learn more: http://www.eurekalert.org/pub_releases/2010-12/miot-sd3121510.php). The comparison of these '*reconstructed*' ancestral DNA sequences suggests when photosynthetic organisms diversified and when our oxygenic planet became a reality.

D. Origins of Life

Living things were once divided into 5 kingdoms. This classification has been replaced by 3 domains of life. For more detail, check out Woese CR (1998) *The universal ancestor*. Proc. Nat. Acad. Sci. 95:6854-6859. The molecular analyses discussed above lead to the conclusion that all organisms alive today descended from a last universal common ancestor, the **LUCA**. It is now accepted that there was a time, however brief or long, when the earth was a lifeless (prebiotic) planet. But the question of how life began has been with us since the beginnings or recorded history. We will consider how we approach and suggest answers to questions about the origins of life in a later chapter.

VI. Microscopy Reveals Life's Diversity of Structure and Form

For a gallery of light, fluorescence and transmission and scanning electron micrographs, check out this site (compare these with PowerPoint lecture images): [Gallery of Micrographs](#). The following is a brief description of different microscopic techniques and what they can reveal.

- Light microscopy reveals much of cellular diversity ([The Optical Microscope](#)). Check this site through the section on fluorescence microscopy. Click on links to different kinds of light microscopy to see sample micrographs of cell and tissue samples. Also check micrographs and corresponding [Drawings of Mitosis](#) section for a reminder of how eukaryotic cells divide.
- A 100 year-old variant of light microscopy, [Lattice Light-Sheet Microscopy](#), was recently updated to allow us to follow subcellular structures and macromolecules moving about in living cells. It was recently applied to follow the movement and sub-cellular cellular location of RNA molecules associated with proteins in structures called RNA granules (check it out at [RNA Organization in a New Light](#)).

- Confocal microscopy is a special form of fluorescence microscopy that enables imaging through thick samples and sections. The result is often 3D-like, with much greater depth of focus than other light microscope methods. Click at [Gallery of Confocal Microscopy Images](#) to see a variety of confocal micrographs and related images; look mainly at the specimens.
- Transmission electron microscopy (TEM) achieves more power and resolution than any form of light microscopy ([Transmission Electron Microscopy](#)). Together with biochemical and molecular biological studies continues to reveal how different cell components work with each other (see cell fractionation, below). The higher voltage in *High Voltage Electron microscopy* is an adaptation that allows TEM through thicker sections than regular (low voltage) TEM. The result is micrographs with greater resolution and contrast.
- Scanning Electron Microscopy (SEM) allows us to examine the surfaces of tissues, small organisms like insects, and even of cells and organelles ([Scanning Electron Microscopy](#); check this web site through *Magnification* for a description of scanning EM, and look at the gallery of SEM images at the end of the entry).

Some iText & VOP Key words and Terms

Actin	Eukaryotes	Nuclear envelope
Archaea	Eukaryotic flagella	Nuclear pores
Bacterial cell walls	Evolution	Nucleoid
Bacterial Flagella	Exocytosis	nucleolus
Binary fission	Extinction	Nucleus
Cell fractionation	Hypothesis	Optical microscopy
Cell theory	Inference	Plant cell walls
Chloroplasts	Intermediate filaments	Plasmid
chromatin	keratin	Progenote
Chromosomes	Kingdoms	Prokaryotes
Cilia	LUCA	Properties of life
Confocal microscopy	Lysosomes	Rough endoplasmic reticulum
Cytoplasm	Meiosis	Scanning electron microscopy
Cytoskeleton	Microbodies	Scientific method
Cytosol	Microfilaments	Secretion vesicles

Deduction	Microtubules	Smooth endoplasmic reticulum
Differential centrifugation	Mitochondria	Speciation
Diversity	Mitosis	Theory
Domains of life	Motor proteins	Tonoplast
Dynein	Mutation	Transmission electron microscopy
Endomembrane system	Natural selection	Tubulins

Chapter 2: Basic Chemistry, Organic Chemistry and Biochemistry

Basic chemistry (chemical bonding (covalent, polar covalent, ionic, H-bonds; Water properties, water chemistry, pH); Organic molecules and Biochemistry (chemical groups, monomers, polymers, condensation and hydrolysis); Macromolecules (polysaccharides, lipids, polypeptides & proteins, DNA, RNA)

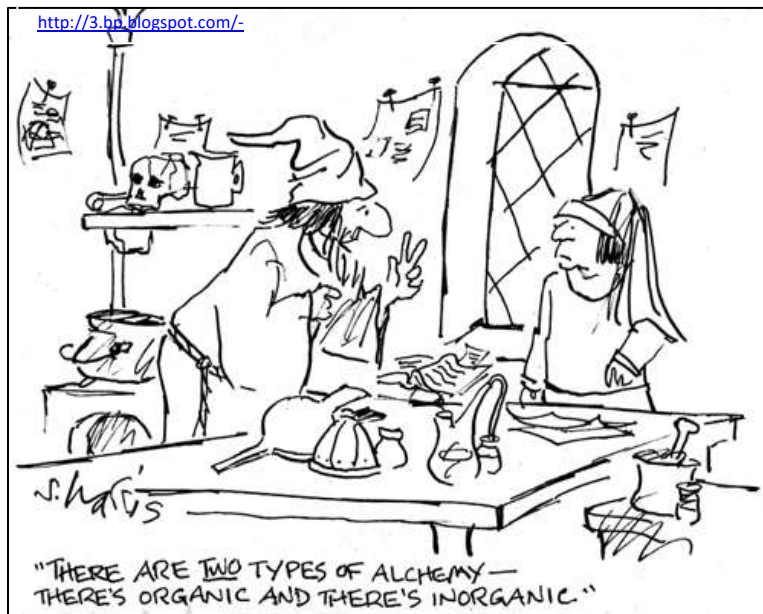

I. Introduction

In this chapter we review basic chemistry from atomic structure to molecular bonds to the structure and properties of water, followed by a review of key principles of organic chemistry - the chemistry of carbon-based molecules. You may find it useful to have your old general chemistry textbook handy, or check out [Pauling L (1988) *General Chemistry* New York, Springer-Verlag] for an excellent introduction to general chemistry.

We'll see how the *polar covalent* structure of water explains virtually all properties of water from the energy required to melt or vaporize a gram of water to its surface tension to its ability to hold heat... not to mention its ability to dissolve a wide variety of *solutes* from salts to proteins and other macromolecules. We'll distinguish *hydrophilic* interactions from water's *hydrophobic* interactions with lipids and fatty components of molecules. Finally, we'll review some basic biochemistry. We'll look common reactions by which small

monomers get linked to form large polymers (macromolecules) like polysaccharides, polypeptides and polynucleotides (DNA, RNA). We'll also see the reactions that break macromolecules down to their constituent monomers. For example amylose, a component of starch, is a large simple *homopolymer* of repeating glucose monomers. Polypeptides are *heteropolymers* of 20 different *amino acids*, while the DNA and RNA nucleic acids are *heteropolymers* made using only 4 different *nucleotides*. So, when we eat a meal, we digest the plant or animal polymers back down to monomers by a process called *hydrolysis*. In hydrolysis, a water molecule is 'added' across the bonds linking the monomers in the polymer. When the monomeric digestion products get into our cells, they can be assembled into our own macromolecules by removing those water molecules, the process called *condensation*, or *dehydration*. While fats (triglycerides) and phospholipids are not (strictly speaking) macromolecules, we'll see that they breakdown and form by hydrolysis and condensation, respectively. Fats are of course an important energy molecule, and phospholipids, chemical relatives of fats that are the basis of cellular membrane structure.

Many cellular structures are based on macromolecules interacting with each other via many relatively weak bonds (H-bonds, electrostatic interactions, Van der Waals forces). Even the two complementary DNA strands are held in a stable double helix by millions of H-bonds between the bases in the nucleotides in opposite chains. Monomers also serve other purposes related to energy metabolism, cell signaling etc. The links to websites (mostly Wikipedia) on atoms and basic chemistry are more detailed than required for this course, but depending on your chemistry background, you may find "googling" these subjects interesting and useful. Of course, use the VOPs and/or the un-narrated PowerPoints as the guide to what you must understand about the basic chemistry and biochemistry presented here.

Voice-Over PowerPoint Presentations

[Chemistry and the Molecules of Life](#)

[Biochemistry Part 1: Carbohydrates, Lipids & Proteins](#)

[Biochemistry Part 2: DNA, RNA, Macromolecular Assembly](#)

Learning Objectives

When you have mastered the information in this chapter and the associated VOPs, you should be able to:

1. compare and contrast the definitions of *atom*, *element* and *molecule*
2. articulate the difference between *energy* and *position*-based *atomic models* and the behavior of sub-atomic particles that can absorb energy from and release energy to the environment

3. state the difference between atomic *shells* and *orbitals*
4. state the difference between *kinetic* and *potential* energy and how it applies to atoms and molecules
5. explain the behavior of atoms or molecules that fluoresce when excited by high-energy radiation, and those that don't
6. be able to distinguish between *polar* and *non-polar covalent bonds* between atoms in molecules, and their physical-chemical properties
7. predict the behavior of electrons in compounds held together by *ionic interactions*
8. predict the behavior of highly *soluble* and *insoluble salts* when placed in water and explain that behavior in atomic/molecular terms
9. compare and contrast the different *properties of water* and explain how water's atomic/molecular structure supports these properties
10. draw *monomers* and show how they undergo *dehydration synthesis* to form linkages in *polymers*
11. distinguish between chemical "bonds" and "linkages" in polymers
12. categorize different bonds on the basis of their strengths
13. place hydrolytic and dehydration synthetic reactions in a *metabolic context*

II. Atoms and Basic Chemistry

A. Overview of Elements and Atoms

Let's first deal with the difference between *elements* and *atoms*, which are often confused in casual conversation! Both terms describe *matter*, substances with *mass*. The atom is the fundamental unit of matter. Every atom consists of a nucleus surrounded by a cloud of electrons in motion. The different elements are different kinds of matter distinguished by different physical and chemical properties. These properties are in turn defined by differences in the mass and structure of their atoms, i.e., the number of protons and neutrons in the nucleus and the arrangement of the orbiting electrons. The nuclei of atoms of most elements contain positively charged *protons* and uncharged (electrically neutral) *neutrons*; the exception is hydrogen, whose most stable atoms lack neutrons. Electrons are negatively charged and are maintained in their atomic orbits because of electromagnetic forces created in part by their attraction to the positively charged nuclei. Protons and neutrons account for most of the mass of atoms. They are about 2000X (more precisely, between 1836X-1839X) more massive than electrons.

The same electromagnetic forces that keep electrons orbiting their nuclei may cause atoms to combine to form molecules in which atoms are linked by chemical bonds. Whether or not a given element can form chemical bonds with another element is determined by the unique mass and structure of their atoms. Recall that atoms are physically most stable when they are electrically uncharged, with an equal number of protons and electrons. But atoms of the same element can have a different number of neutrons. *Isotopes* are atoms of the same element with different than the usual number of neutrons. For example, the most abundant isotope of hydrogen contains one proton and one electron. The nucleus of the hydrogen isotope *deuterium* contains a neutron; *tritium* contains 2 additional neutrons. While some isotopes may be less stable than others (tritium is radioactive and subject to nuclear decay over time), they all share the same chemical properties and behave the same way in chemical reactions. In chemical interactions, some atoms can gain or lose electrons, becoming charged ions; atoms do not lose protons or neutrons as a result of chemical interactions. Up to two electrons move in a space defined as an *orbital*. In addition to occupying different areas around the nucleus, electrons exist at different *energy levels*, moving with different *kinetic* energies. Electrons can also absorb or lose energy, jumping or falling between energy levels. The number and arrangement of electrons in the atoms of an element ultimately determine its chemical and physical (electromagnetic) properties. We model atoms to illustrate the average physical location of electrons (*the orbital model*) on one hand, and their energy levels (the *Bohr*, or *shell model*) on the other (illustrated for helium, below).

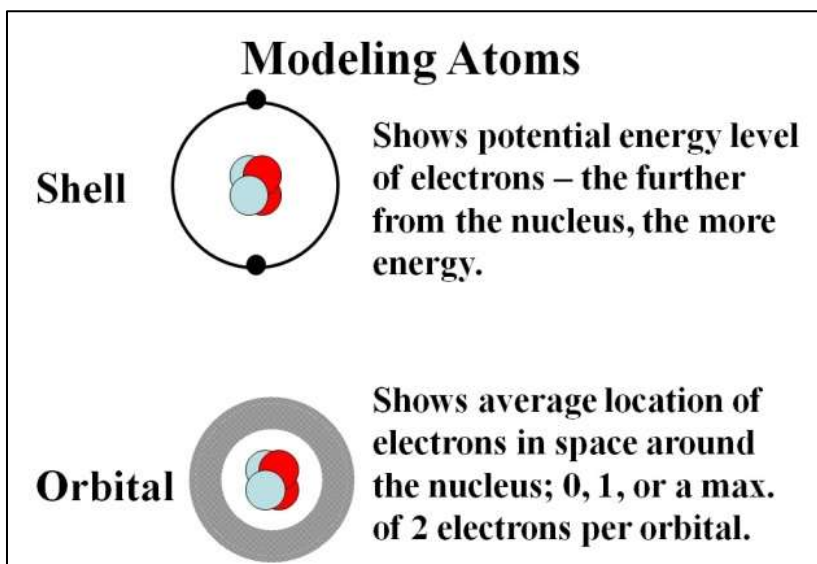

Atoms of different elements are characterized by their *atomic number* (the number of their protons) and their atomic mass (*mass number*, usually measured in *Daltons*, or *Da*). Take the element carbon: the mass of the most common isotope of carbon is 12, its atomic mass number. Each element has a symbol whose atomic structure is defined by superscripted atomic number and its subscripted atomic mass. In the partial periodic table below, note the elements essential for life in greater or lesser amounts, as well as some that may also be essential in humans.

Elements Found in Organisms
...based on the distribution of electrons in shells

Valence: # of unpaired electrons in outer shell; determines chemical properties of the element

1																	0		
¹ ₁ H																	² ₂ He		
1	2													3	4	3	2	1	0
Li	Be													⁵ ₁₁ B	⁶ ₁₂ C	⁷ ₁₄ N	⁸ ₁₆ O	⁹ ₁₉ F	He
¹¹ ₂₃ Na	¹² ₂₄ Mg													Al	¹⁴ ₂₈ Si	¹⁵ ₃₁ P	¹⁶ ₃₂ S	¹⁷ ₃₅ Cl	Ar
¹⁹ ₃₉ K	²⁰ ₄₀ Ca	Sc	Ti	²³ ₅₁ V	²⁴ ₅₂ Cr	²⁵ ₅₅ Mn	²⁶ ₅₆ Fe	²⁷ ₅₉ Co	²⁸ ₅₉ Ni	²⁹ ₆₄ Cu	³⁰ ₆₅ Zn	Ga	Ge	As	³⁴ ₇₈ Se	Br	Kr		
Rb	Sr	Y	Zr	Nb	⁴² ₉₀ Mo	Tc	Ru	Rh	Pd	Ag	Cd	In	Sn	Sb	Te	⁵³ ₁₂₇ I	Xe		

blue elements: 99.0% of atoms in the human body
purple elements: 0.9% of atoms in the human body
green elements: required in trace amounts
brown elements: may be required by human cells

The nucleus of the carbon isotope in this table contains 6 protons and 6 neutrons, and therefore has an atomic mass of 12 Da. At about 1/2000th the mass of the neutrons and protons, carbon's electrons do not amount to much of its atomic mass!

CHALLENGE: The most abundant isotope of hydrogen is shown in the table. What are the masses of the 3 common isotopes of hydrogen?

B. Electron Configuration – Shells and Subshells

The *Bohr* model of the atom allows a convenient way to think about the *kinetic energy* of electrons, and how electrons can absorb and release energy. The shells indicate the energy levels of electrons. Typically, beaming radiation (visible or UV light for

example) at atoms can excite electrons. Electrons can absorb energy (radiation, light, electrical). If an electron absorbs a full *quantum* of energy (or *photon* radiant energy) it will be excited from the *ground state* (the shell it normally occupies) into a higher shell. Having absorbed this energy, the electron now moves at greater speed around the nucleus. Thus the excited electron has more kinetic energy than it did 'at ground' (below).

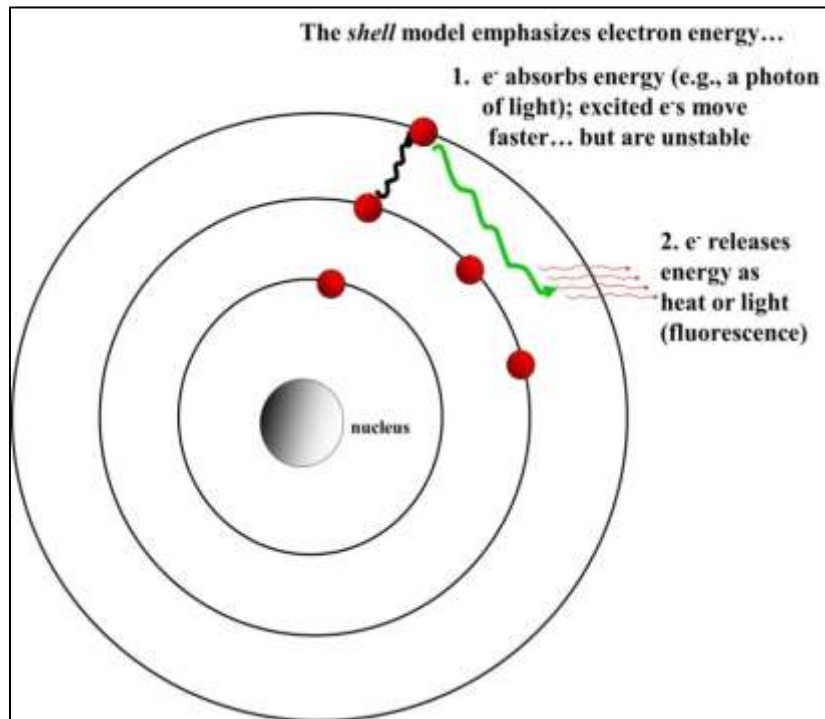

Excited electrons are unstable, and will eventually return to their ground state (and their lower energy shell). The ground state is sometimes also called the 'resting state', but electrons at ground are by no means resting! They simply move with less kinetic energy than when excited. Since electrons are more stable at ground state, excited electrons will release some of the energy they originally absorbed. In most cases, this energy is released as heat. But in some cases, they will release the energy as light. Atoms and molecules whose excited electrons release visible light as they return to ground state are called *fluorescent*. The most obvious example of this phenomenon is the fluorescent light fixture in which electrical energy excites electrons out of atoms in molecules coating the interior surface of the bulb. As all those excited electrons return to ground state (only to be re-excited again), they release the fluorescent light. As we shall see, biologists and chemists have turned fluorescence into a tool of biochemistry, molecular biology and microscopy.

III. Chemical bonds

Atoms combine to make molecules by forming bonds. *Covalent bonds* are strong bonds. They involve unequal or equal sharing of electrons, leading to *polar covalent bonds* vs. non-polar covalent bonds respectively. *Ionic bonds* are weaker than covalent bonds. They are created by electrostatic interactions between elements that gain or lose electrons. *Hydrogen (H-) bonds* are in a class by themselves! These electrostatic interactions account for the physical and chemical properties of water and are involved in the interactions between and within molecules and macromolecules. We'll look more closely at these bonds at how even the weak bonds are essential to life.

A. Covalent Bonds

Hydrogen gas is a molecule, not an atom! A single covalent bond forms between two H atoms that share their two electrons equally. Methane consists of a single carbon (C) atom and four hydrogen (H) atoms forming covalent bonds in which C and H electrons on the C and H atoms are shared equally (below).

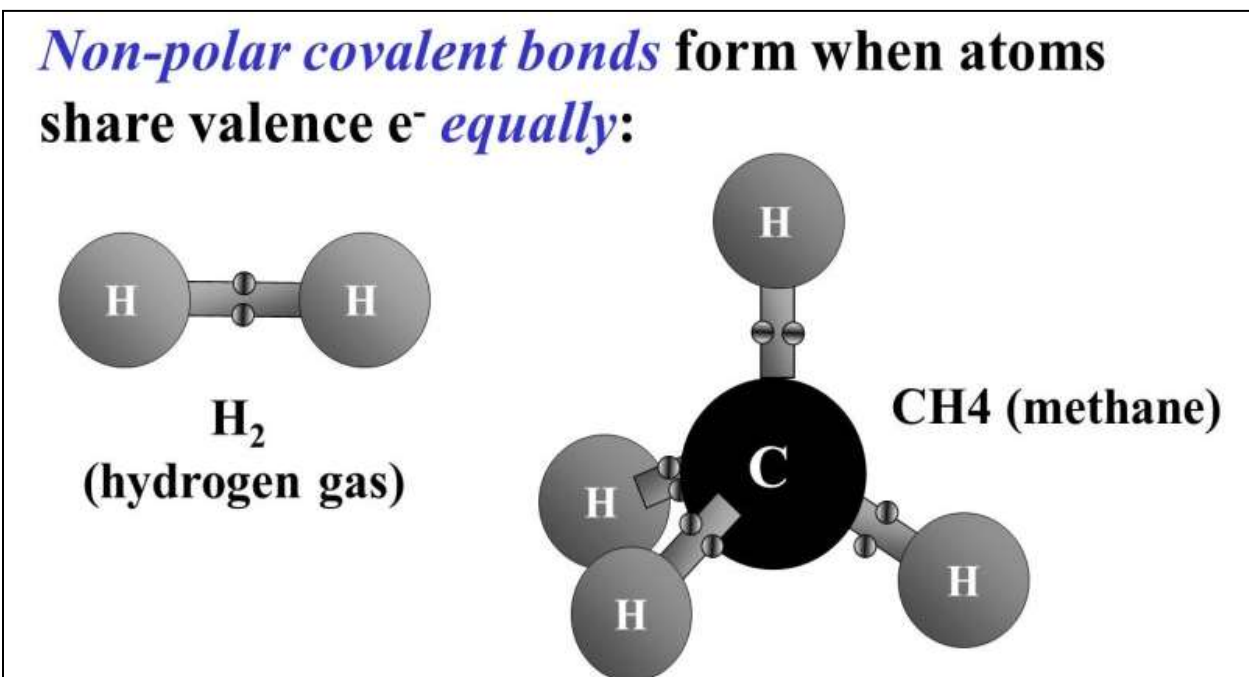

The C atom has 4 electrons in its outer shell which it can share. Each H atom has a single electron to share. If the C atom shares its four electrons with the four electrons in the four H atoms, there will be 4 paired electrons (8 in all) moving in filled orbitals around the C atom nucleus some of the time, and around each of the H atomic nuclei some of the time. In effect, the outer shell of the C atom and each

of the H atoms are filled at least some of the time. This stabilizes the molecule; recall that atoms are most stable when their outer shells are filled and each electron orbital is filled (i.e., with a pair of electrons). The bonds in methane and hydrogen gas are *non-polar covalent bonds* because the electrons in the bonds are shared equally.

If the nuclei of atoms in a molecule are more different in size than C and H, the electrons in the bonds might not be shared equally. This is the case with water (shown below).

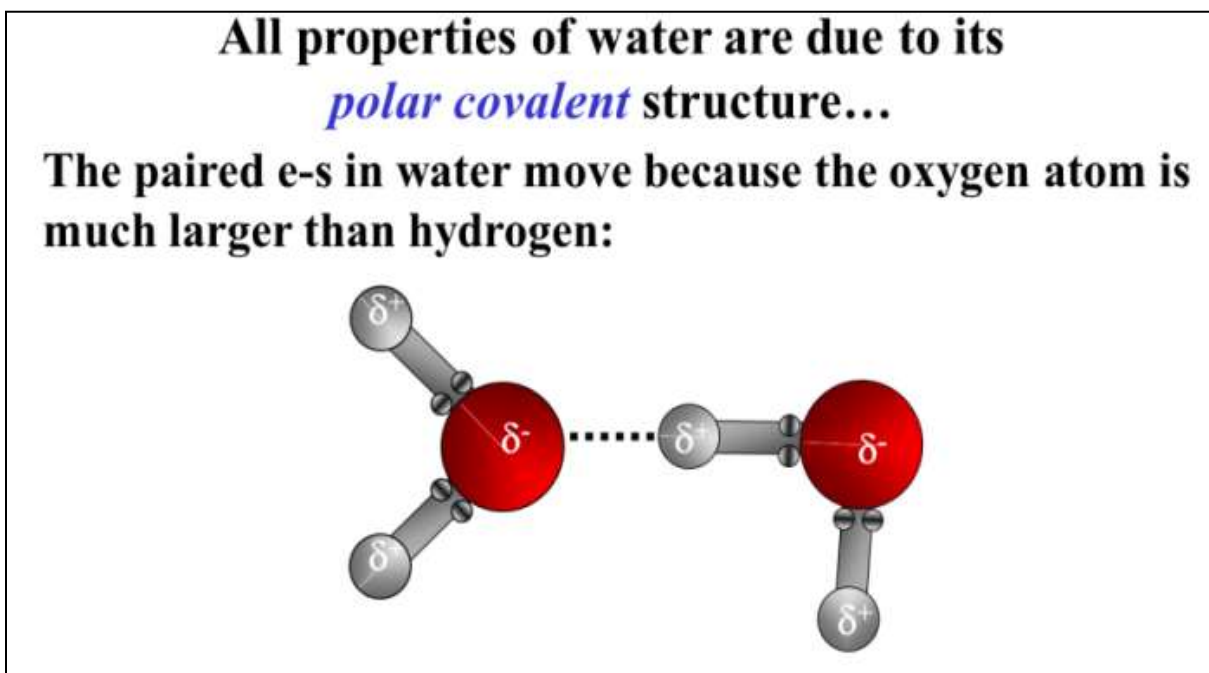

The larger nucleus of the oxygen atom in H₂O attracts electrons more strongly than the two H atoms, so that the shared electrons spend more of their time around the O atom. Compare the position of the paired electrons in water with those in hydrogen gas or methane). Such bonds are called *polar covalent bonds* because the O atom will carry a partial negative charge while each of the H atoms will carry a partial positive charge. The partial charges are indicated by the Greek letter delta (δ). The polar covalent nature of water allows it to interact with other polar molecules and with itself. In the illustration, the partial (and opposite) charges of two water molecules attract each other.

To see YouTube animations of the many properties of water arising out of its polar-covalent structure, click http://youtu.be/g6Ra9_c2laQ. The polar covalent nature of water goes a long way to explaining the physical and chemical properties of water... and why water is essential to life on this planet!

Both polar and non-polar covalent bonds play a major role on the structure of macromolecules, like insulin, the protein hormone shown below.

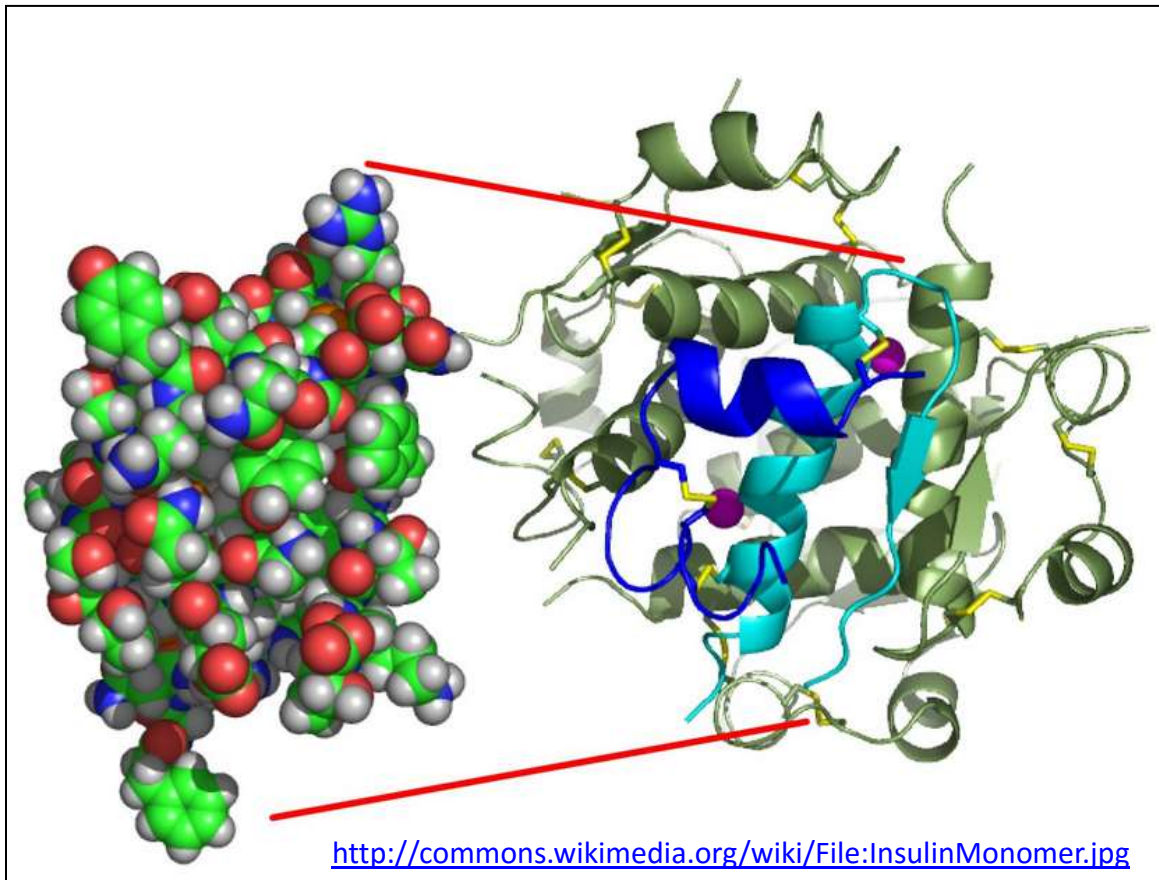

A space-filling model of the *hexameric form of stored insulin* on the left emphasizes its tertiary structure based on X-Ray crystallography... that is, how the structure might look if you could actually see it. The so-called *ribbon diagram* on the right highlights regions of internal secondary structure within the protein. When secreted from Islets of Langerhans cells in the pancreas, active insulin is a dimer of two polypeptides, shown here in turquoise and dark blue. Almost hidden towards the lower left of the illustration are the two disulfide bridges (yellow “V”s) holding together the two polypeptides. Except for these two covalent disulfide bonds, insulin subunit structure and the interactions holding the subunits together are based on many electrostatic interactions (including H-bonds) and other weak interactions, Protein structure is covered in more detail in a separate chapter.

For more about covalent bonds, see [About Covalent Bonds \(from Wikipedia\)](#).

B. Ionic Bonds

When atoms gain or lose electrons, they form ions, so by definition, ions carry either a negative or positive charge. Ions are produced when atoms can obtain a stable number of electrons by giving up or gaining electrons. Common table salt is a good example (illustrated below).

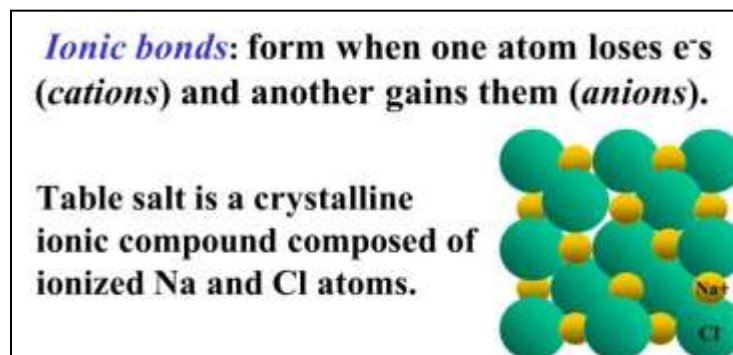

Na (sodium) can donate a single electron to Cl (chlorine) generating Na^+ and Cl^- . The ion pair is held together in crystal salt by the *electrostatic interaction* of opposite charges. Look up the Bohr models of these two elements and see how ionization of each leaves filled outer shells (energy levels) in the ions.

IV. A Close Look at Water Chemistry

A. Hydrogen Bonds, the Polarity and Properties of Water

Hydrogen bonds are a subcategory of electrostatic interaction (i.e., formed by the attraction of oppositely charges). As noted above, water molecules cohere (stick to one another) because of strong electrostatic interactions that form H-bonds. These interactions lead to the formation of hydrogen bonds, or *H-bonds*. Another consequence of water's polar covalent nature is that it is a good solvent because it is attracted to other charged molecules and molecular surfaces. In doing so, the water molecules typically form H-bonds with the dissolving molecules. Water-soluble molecules or molecular surfaces that are attracted to water are referred to as *hydrophilic*. Lipids like fats and oils are not polar molecules and therefore that do not dissolve in water; they are *hydrophobic*.

When soluble salts like NaCl are mixed with water, the salt dissolves because the Cl^- and Na^+ ions are more strongly attracted to the partial positive and negative charges (respectively) of multiple water molecules. The result is that the ions separate as they dissolve. We call this separation of salt *ionization*.

The dissolution of NaCl in water is an example of the solvent properties of water (shown below).

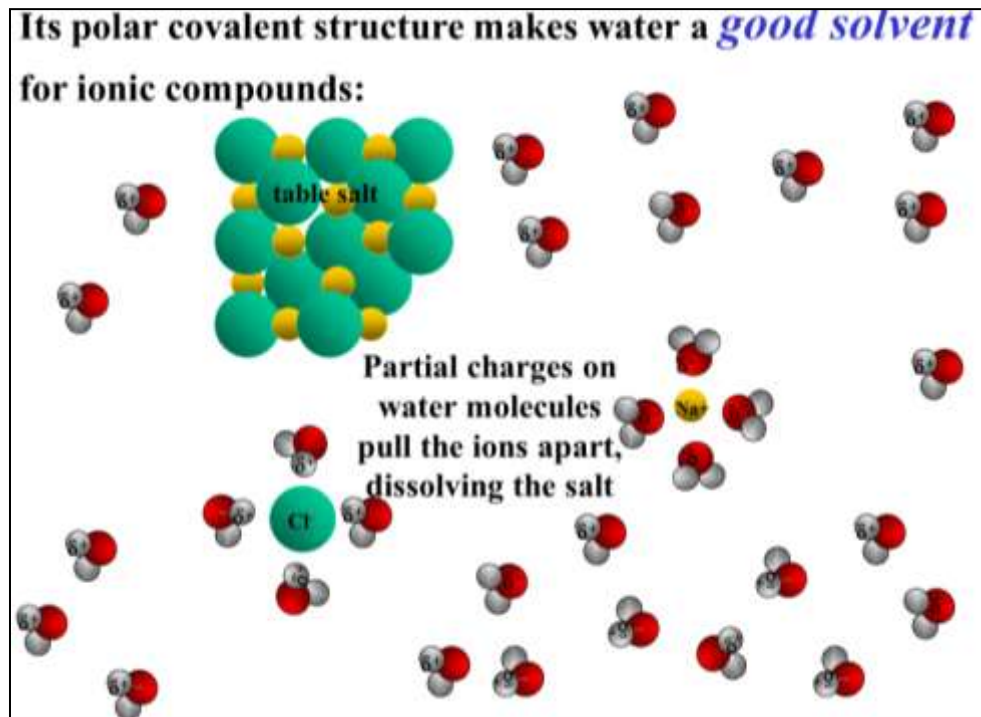

Water is also a good solvent for macromolecules (proteins, nucleic acids) with exposed polar chemical groups on their surfaces. These charged groups attract water molecules as shown below.

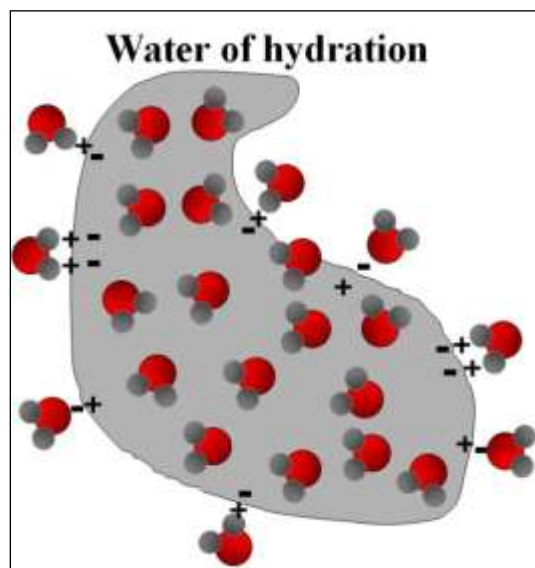

In addition to being a good solvent, we define the following properties of water:

- *Cohesion*: the ability of water molecules to stick together via hydrogen bonds (H-bonds).
- *High Surface tension*: water's high cohesion means that it can be hard to break the surface (think the water strider insect that "walks" on water).
- *Adhesion*: the ability of water to form electrostatic interactions with ions and other polar covalent molecules.
- *High specific heat*: water's cohesive properties are so strong that it takes a lot of energy to heat water (1 *Kcal*, or *Calorie*, with a capital C) to heat a gram of water by 1°C.
- *High heat of vaporization*: It takes even more energy/gram of water to turn it into water vapor!

In fact, all of these properties of water are based on its polar nature and H-bonding abilities that attract other water molecules as well as ions and other polar molecules.

B. Water Ionization and pH

One last property of water – it can ionize, forming H^+ and OH^- ions or more correctly, pairs of water molecules form H_3O^+ and OH^- ions. When an acid is added to water, H^+ ions (in fact, *protons*!) dissociate from the acid molecule, increasing the number of H_3O^+ ions in the solution. Acidic solutions have a pH below 7.0 (neutrality). When bases are added to water, they ionize and release OH^- (hydroxyl) ions which remove H^+ ions (protons) from the solution, raising the pH of the solution. To review the basics of acid-base chemistry:

When dissolved in water,

- Acids release H^+
- Bases accept H^+

Since the pH of a solution is the negative logarithm of the hydrogen ion concentration,

- at pH 7.0, a solution is neutral
- below a pH of 7.0, a solution is acidic
- above a pH of 7.0, a solution is basic

V. Some Basic Biochemistry: Monomers and Polymers; the Synthesis and Degradation of Macromolecules

The common themes for how living things build and break down macromolecules involve dehydration (or condensation) and hydrolysis reactions, respectively. One reaction is essentially the reverse of the other, as illustrated below:

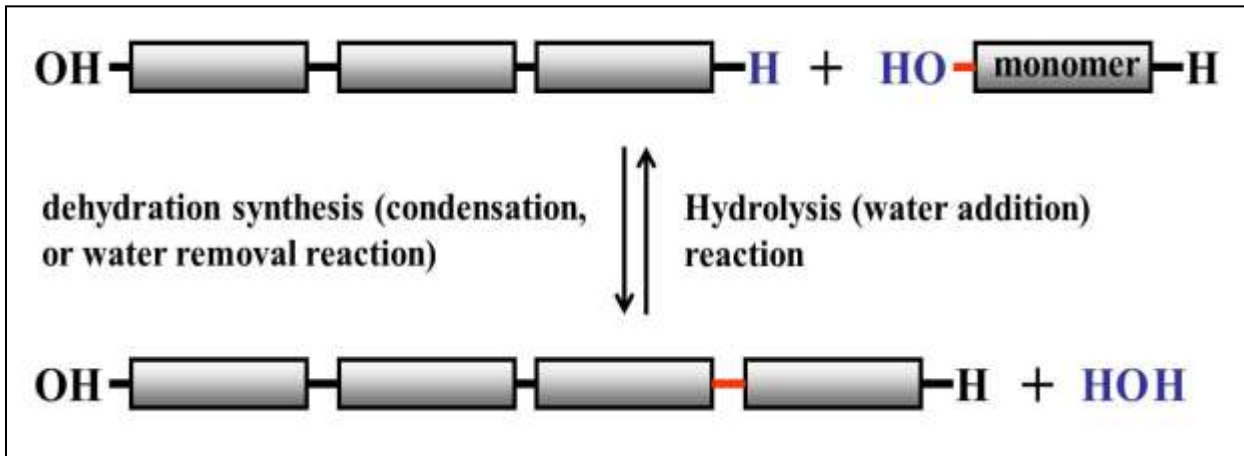

Dehydration synthesis (condensation) reactions build macromolecules by removing a water molecule from the interacting molecules. For example, the forward reaction between two amino acids (below left) forms a peptide bond (or *peptide linkage*) between the amino acids (below right).

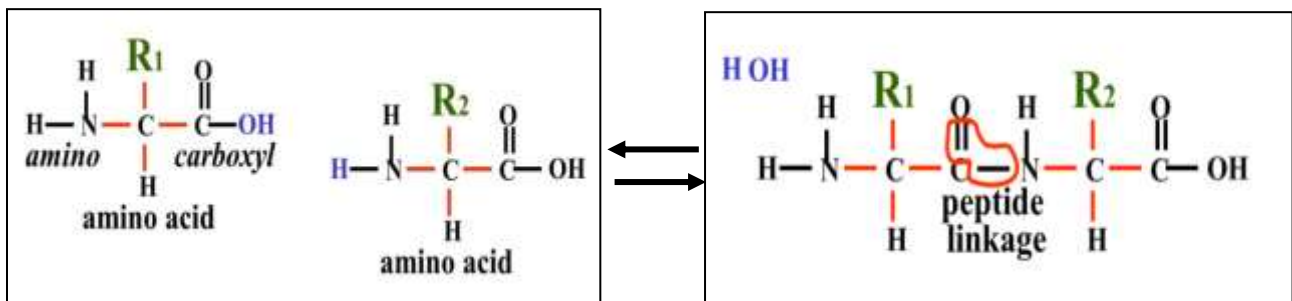

The bond that forms in a condensation reaction is really not a single bond, but a linkage involving several bonds! The linkage is formed by removing an OH on one monomer and an H group on the other (to make water and the linkage between the monomers). Subunits in other biological polymers, such as nucleic acids, carbohydrates, etc. are also linked by condensation reactions in which water is expelled.

Hydrolysis reactions involve the addition of water molecules across linkages connecting monomers or other molecular groups. The hydrolysis of peptide linkages, shown as the reverse reaction in the illustration, would happen in your stomach and small intestines after a protein-containing meal. Polymers are hydrolyzed by water addition across the linkages originally formed during condensation reactions.

Condensation reactions are key reactions in the synthesis of large molecules (macromolecules like polypeptides, polysaccharides, DNA, RNA, etc.). Glucose is a monomer of starch in plant and glycogen in animals. We build proteins from amino acids and we synthesize nucleic acids (DNA and RNA) from nucleotide monomers. Even fats and membrane phospholipids are built from smaller components in condensation reactions.

When we eat a meal, we digest the macromolecules in food back down to monomers by hydrolysis. That's how our cells get to finish the job of turning a cow or turnip into you and me! For more detail, check out other chapters in this text and see the links below:

- [About Glucose and its Polymers \(from Wikipedia\)](#)
- [About Amino Acids and Polypeptides \(from Wikipedia\)](#)
- [Nucleotides and Nucleic Acids \(from Wikipedia\)](#)
- [About Fats \(from Wikipedia\)](#)
- [About Phospholipids \(from Wikipedia\)](#)

Some iText & VOP Key Words and Terms

acids and bases	hydrogen bonds	photon
adhesion	hydrolysis	polar covalent bonds
amino acids	hydrophilic	polymers
atom	hydrophobic	polynucleotides
atomic mass	ionic bonds	polypeptides
Bohr model	ionization	polysaccharides
Carbohydrates	isotopes	potential energy
cohesion	kinetic energy	properties of water
dehydration synthesis	lipids	protons
digestion	macromolecules	quantum
DNA	molecule	RNA
electron shell	monomers	salts

electrons	neutrons	scanning tunneling microscope
electrostatic interaction	nucleotides	sharing electrons
element	orbitals	solutes
Ester linkage	partial charge	specific heat
excitation	peptide linkage	surface tension
fats	pH	triglycerides
fluorescence	phospholipids	valence
glycoside linkage	phosphate ester linkage	Van der Waals forces
heat of vaporization	phosphodiester linkage	water ions
		water of hydration

Chapter 3: Details of Protein Structure

Protein Structure and Configuration: Primary, Secondary, Tertiary, Quaternary; Protein Folding, Domains and Motifs, Studying Proteins

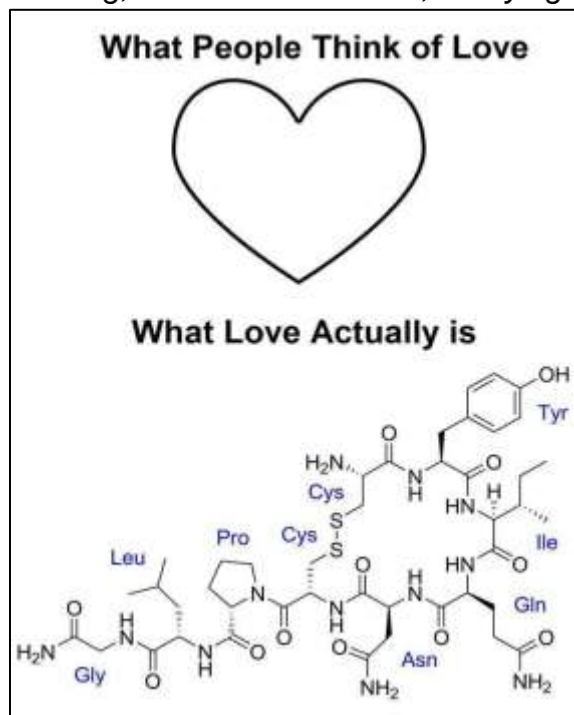

http://static.fjcdn.com/pictures/Chemistry_7fd285_5046342.jpg

I. Introduction

Proteins are the work-horses of cells, responsible for just about all aspects of life (look at oxytocin in the cartoon)! Comprised of one or more *polypeptides*, they:

- are the catalysts that make biochemical reactions possible
- are components of membranes that selectively let substances into and out of the cell,
- are the basis of a cell's ability to respond to changes in the environment and more generally to communicate with one another
- form the internal structure (*cytoskeleton*) of cells
- allow cells to move and muscles to contract
- are in fact responsible for many other cell functions

In this chapter, we look at the different *levels* of protein structure and what it takes to be a functional protein. The *primary* (1°) *structure* of a polypeptide is its amino acid

sequence. Amino acid interactions near each other in the sequence cause the polypeptide to fold into its *secondary* (2°) *structure* (α helix, β -, or pleated sheet). *Tertiary* (3°) *structure* forms when the polypeptide further folds into more a complex 3-dimensional structure. The accurate folding of a polypeptide into a correct and active molecule is typically mediated by other proteins (called *chaperones*!). Tertiary structure is the result of many non-covalent interactions occasionally stabilized by covalent bond formation between amino acid side-chains at some distance from one another in the primary sequence. *Quaternary* (4°) structure refers to proteins made up of two or more polypeptide subunits. Finally, some proteins associate with metal ions (e.g., Mg^{++} , Mn^{++}) or small organic molecules (e.g., heme) before they become functionally active. Finally, we'll look at some techniques for studying protein structure. As with any discussion of molecular (especially macromolecular) function, a recurring theme emerges: the function of a protein depends on its *conformation* - that is, the location of critical *functional groups* (usually amino acid side chains) and their *charge configuration*.

Conformation or *shape* defined this way accounts for what other molecules a protein can interact with. Watch for this theme as we look at enzymes catalysis, the movement of molecules in and out of cells, the response of cells their environment, the ability of cells and organelles to move, DNA replication, gene transcription and regulation, protein synthesis and more.

Voice-Over PowerPoint Presentations

[Proteins: Structure & Function](#)

[Proteins: How We Study Them](#)

Learning Objectives

When you have mastered the information in this chapter and the associated VOPs, you should be able to:

1. distinguish between the orders of protein structure based on the atomic and molecular interactions responsible for each order.
2. differentiate beta sheet, alpha helix and random coil structure based on the atomic interactions involved on each.
3. formulate an hypothesis for why the amino acid glycine is a disruptor of alpha helical polypeptide structure.
4. compare and contrast motif and domain structure of proteins and polypeptides, and their contribution to protein function.
5. describe different techniques for studying proteins and the physical/chemical differences between proteins that make each technique possible.
6. explain the relationship between shape/configuration, cell function and communication, and the notion of molecular communication.

II. Protein Structure

Refer to the 4 levels of protein structure below as you continue to explore them in detail.

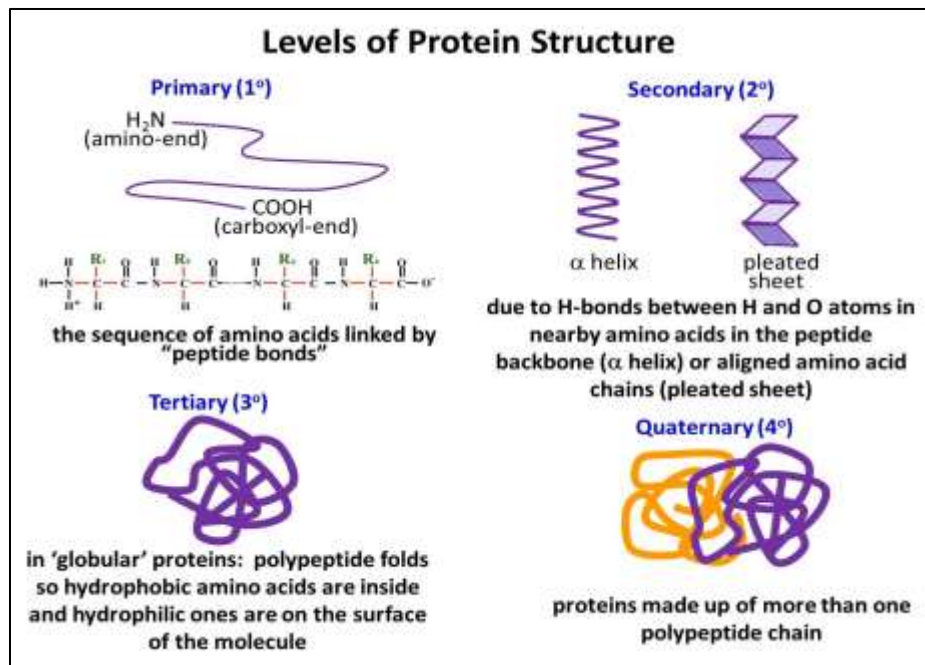

A. Primary structure

The *primary structure* refers to amino acid linear sequence of the polypeptide chain as shown below.

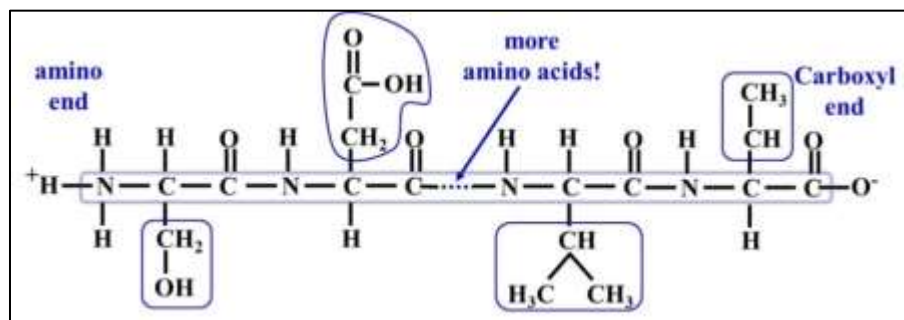

The polypeptide (C-N-C-N-...) *backbone* is indicated. The amino acid side chains (circled in blue) end up on alternate sides of the backbone because of the covalent bond angles along the backbone. You could prove this to yourself by assembling a short polypeptide with a very large version of the molecular modeling kit you might have used in a chemistry class! The amino acids are held together by *peptide bonds* created by dehydration synthesis during cellular protein synthesis (*translation*). The

peptide “bonds” are actually linkages involving multiple covalent bonds. They are formed between the carboxyl and amino groups of adjacent amino acids. The result is a polypeptide chain with a *carboxyl* end and an *amino* end.

Frederick Sanger was the first to demonstrate a practical method for sequencing proteins when he reported the amino acid sequence of the two polypeptides of *bovine insulin*. In brief, the technique involved a stepwise chemical hydrolysis of polypeptide fragments (called an Edman Degradation) leaving behind a fragment shortened by one amino acid, the amino acid *residue* which could then be identified. For this feat he received a Nobel Prize in 1958! Counting of amino acids always starts at the N-terminal end (with a free NH₂-group). Primary structure is dictated directly by the gene encoding the protein. A specific sequence of nucleotides in DNA is transcribed into mRNA, which is read by a ribosome during translation. For some time now, the sequencing of DNA has replaced most direct protein sequencing. The method of DNA sequencing, colloquially referred to as the *Sanger dideoxy* method, quickly became widespread and was eventually automated, enabling rapid gene (and even whole genome) sequencing. Now, instead of directly sequencing polypeptides, amino acid sequences are inferred from the sequences of genes isolated by cloning or revealed after complete genome sequencing projects. And yes... this is the same Sanger. And yes – he won a second Nobel Prize for DNA sequencing work in 1980!

We now think that there are 20,000-30,000 protein-coding genes in humans. For some idea of how such estimates are made, check out Pertea M and Salzberg S [(2010) *Between a chicken and a grape: estimating the number of human genes*. Genome Biology 11:206, available at [Estimating the number of genes in the human genome](#)]. But a cell can produce even more polypeptides than the number of genes in a genome! This is possible when cells produce different RNA variants. We knew early on that the proteins in all living things are composed of the same 20 amino acids, albeit in different sequence. This by itself speaks to a common ancestry of all living things. The conservation of some protein sequences in diverse species (e.g., eukaryotic histone proteins) is further testimony to our common ancestry with all eukaryotes.

Many polypeptides are modified after translation, for instance by *phosphorylation* or *glycosylation* (addition of one or more phosphates or sugars respectively, to specific amino acids in the chain). These modifications enhance the molecular and functional diversity of proteins within and across species. However the underlying basis of protein primary structure is the amino acid backbone in which the central or α -carbon atom of each amino acid is bound to four different groups in all but one amino acid. This makes this carbon *chiral* or *optically active* in 19 of the 20 amino acids; only glycine, whose side chain is an H atom, is not optically active (its central C is bound to an amino group, a carboxyl group and two hydrogens). By way of a reminder, optical activity around a carbon atom allows for two enantiomers, or optical isomers of the molecule. Light passing through a solution of one optical isomer will be bent (rotated) in one direction and light passing through the other isomer will be rotated in the

opposite direction. These directions are referred to as *l* (for *levo* meaning left) and *d* (for *dextro* meaning right). Even though both optical forms (*enantiomers*) of amino acids exist in cells, only the L-isomer occurs in biological proteins.

CHALLENGE: Both optical forms of amino acids exist in cells, only the L-isomer occurs in biological proteins. Why do you think that only L-isomers of amino acids might have been selected for use in proteins of living cells today?

The physical and chemical properties of amino acids result from unique side chains, seen above their common *N-C-C* backbones below.

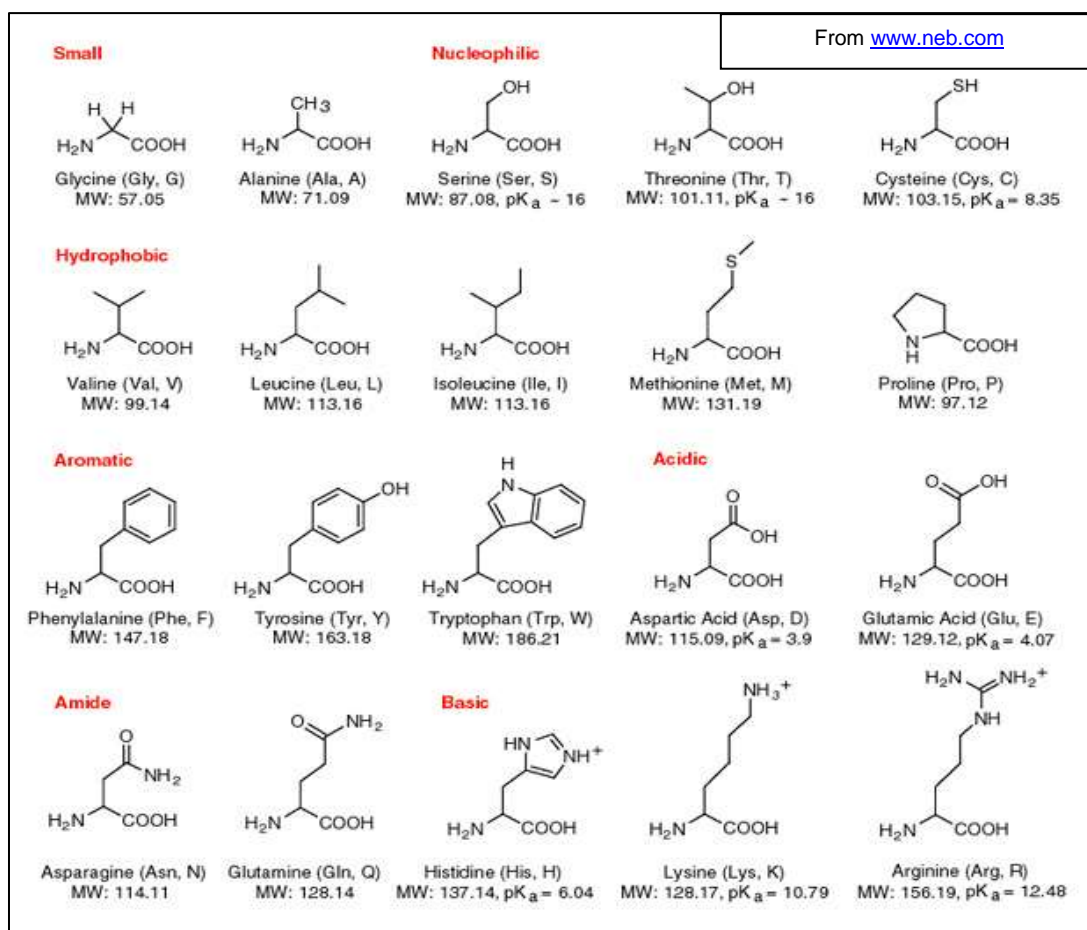

The unique physical and chemical properties of proteins are in turn, determined by the interaction of amino acid side chains within a polypeptide and between polypeptides.

B. Secondary structure

Secondary structure refers to highly regular local structures within a polypeptide (α *helix*) and either within or between polypeptides (β *sheets*). These two types of secondary structure were suggested in 1951 by Linus Pauling and coworkers. These conformations occur due to the spontaneous formation of hydrogen bonds between the main-chain peptide groups, as shown in the two left panels in the drawing below.

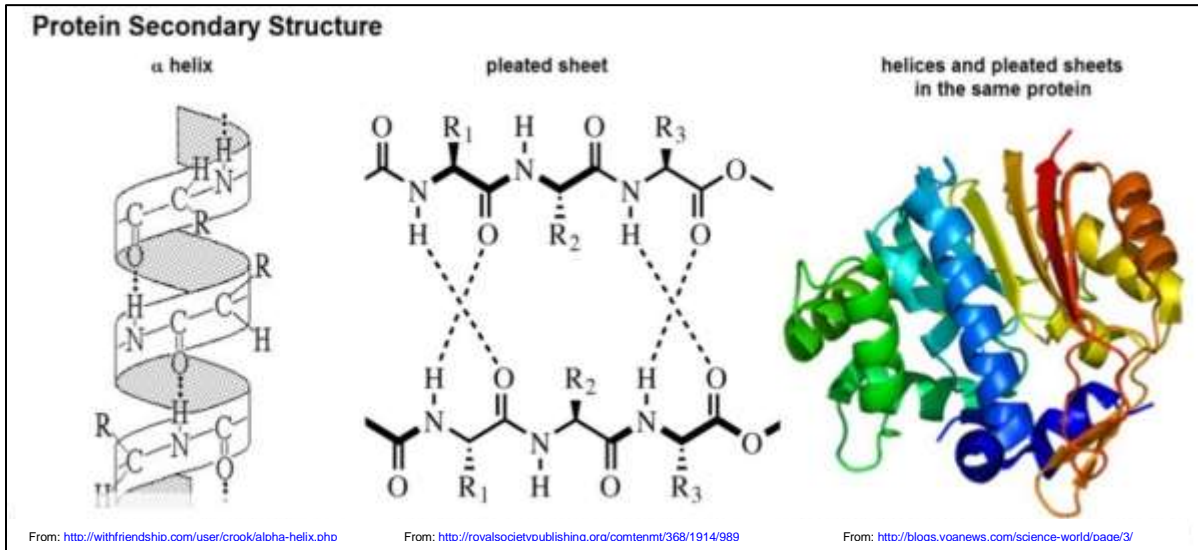

The α helix or β sheets form based on which configuration of hydrogen bonds is most stable. Some parts of a polypeptide may not form either helices or sheets, but are instead lengths of less structured amino acids called *random coils*; these typically connect more structured regions of the molecule. All three of these elements of secondary structure can occur in a single polypeptide or protein, as shown at the right in the illustration above. The pleated sheets are indicated as ribbons with arrow heads representing *N-to-C* or *C-to-N* polarity of the sheets. As you can see, a pair of peptide regions forming a pleated sheet may do so in either the parallel or antiparallel directions (look at the arrowheads of the ribbons), which will depend on other influences dictating protein folding to form tertiary structure.

C. Tertiary structure

When polypeptides fold into more 3-dimensional shapes, they are said to have *tertiary structure*. The α helix or β sheets are folded and incorporated into globular shapes when the more *hydrophobic* and non-polar side chains spontaneously come together to exclude water. In addition, *salt bridges* and hydrogen bonds form between polar side chains that find themselves inside the globular polypeptide. This leaves polar (*hydrophilic*) side chains with no partners on the outer surface of the "globule", where

they can interact with water and thus dissolve the protein (recall *water of hydration*). While based on non-covalent interactions, tertiary structure is relatively stable simply because of the large numbers of these otherwise weak interactions involved in forming the structure. Sometimes, when cysteines far apart in the primary structure of the molecule end up near each other in a folded polypeptide, the $-SH$ (*sulfhydryl*) groups in their side chains may be oxidized to form disulfide bonds, or covalent $-S-S-$ bridges between the two cysteine residues. The oxidation reaction is shown below.

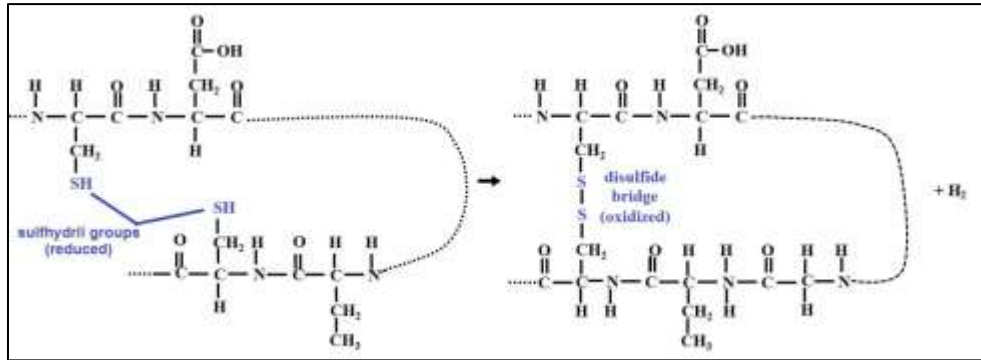

These covalent linkages help to stabilize the tertiary structure of proteins. Imagine a polypeptide with disulfide bridges like the one illustrated below.

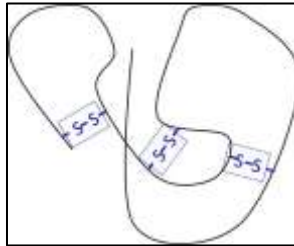

Now imagine a changing environment surrounding the protein. Blood is a good example. Changing the temperature or salt concentration surrounding a protein might disrupt some of the non-covalent bonds maintaining the shape of the active protein. But the disulfide bridges limit the disruption and enable the protein to fold correctly when conditions return to normal (think *homeostasis!*).

CHALLENGE: Proteins with disulfide bonds are more common in extracellular proteins (e.g., those in the circulatory system). Because the cytosol is typically a reducing environment, cysteines in proteins tend to be reduced, remaining in the *sulfhydryl* ($-SH$) state. What does this tell you about blood?

Less well understood is how (or why) some proteins can change conformation in cells, with devastating effects. This seems to be the case for *prions*. When prion proteins were first detected, they were seen to behave as “infectious agents that could reproduce without DNA or other nucleic acid. As you can imagine, this was a highly unorthodox and novel hereditary mechanism. Read about Stanley Prusiner’s Nobel Prize-winning (Medicine, 1997) research on the PrP (prion protein) at <https://en.wikipedia.org/wiki/Prion>. Of course, prions turned out *not* to be reproductive agents of infection after all!

In their normal configuration, prion proteins are harmless and presumably serve important functions in brain neurons. But when they seemingly spontaneously unfold and refold, they aggregate to form visible deposits in cells. In Alzheimer’s disease these deformed prion protein deposits form *amyloid plaques*. Not only that, the misfolded amyloid proteins cause normal prion proteins to refold as well, amplifying the deleterious effects of the plaques in humans with Alzheimer’s, Jacob-Kreutzfeld (“mad cow”) and related diseases. As suggested by its name, Mad Cow also affects animals. This process is illustrated below for Alzheimer’s disease.

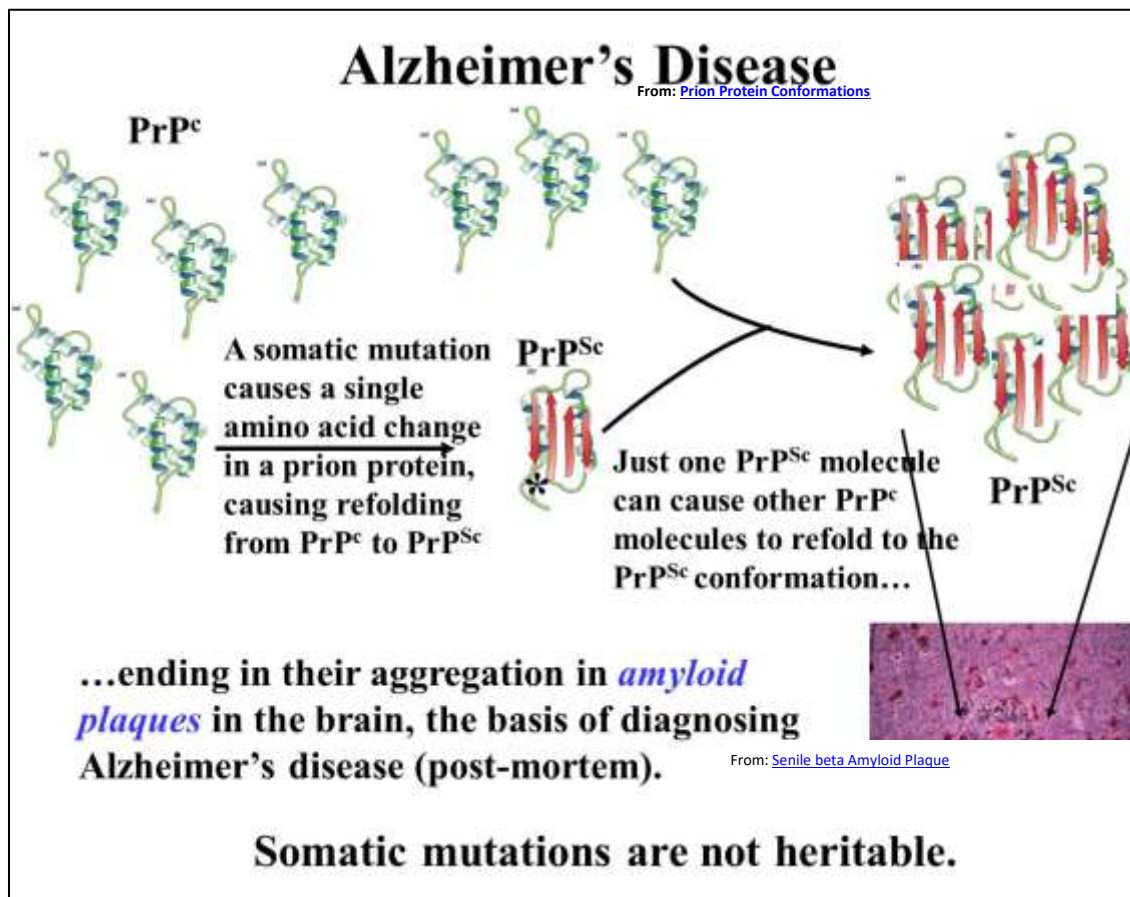

Well, what of a normal function of prion proteins? Recent studies of prions in mice and yeast suggest normal functions in memory formation and sporulation, respectively! Check for some details at: [Prion Proteins May Play a Role in Memory Formation](#) and [A Role for Amyloid Proteins in Yeast Sporulation](#).

Though not characterized as plaques, aggregates that form in brain cells when *alpha-synuclein* undergoes anomalous conformational change, resulting in *MSA (Multiple System Atrophy)* or *Parkinson's Disease* (click [Synuclein Allosterity and Aggregation in Parkinson's Disease](#) to read more details about this recent research). These are examples of other neurodegenerative diseases that result when a single protein changes shape in brain cells.

D. Quaternary structure

Quaternary structure is the three-dimensional structure of a protein composed of two or more polypeptides. In this context, the quaternary structure is stabilized by the same non-covalent interactions and disulfide bonds as the tertiary structure. Proteins with quaternary are called *multimers*. Specifically, a *dimer* contains two polypeptides, a *trimer* contains three polypeptides, a *tetramer* if it contains four polypeptides and so on. Multimers made up of identical subunits are referred to with a prefix of "homo-" (e.g. a homotetramer). Those made up of different subunits are *heteromers*. The vertebrate hemoglobin molecule, consisting of α - and two β - globins (shown below) is a *heterotetramer*.

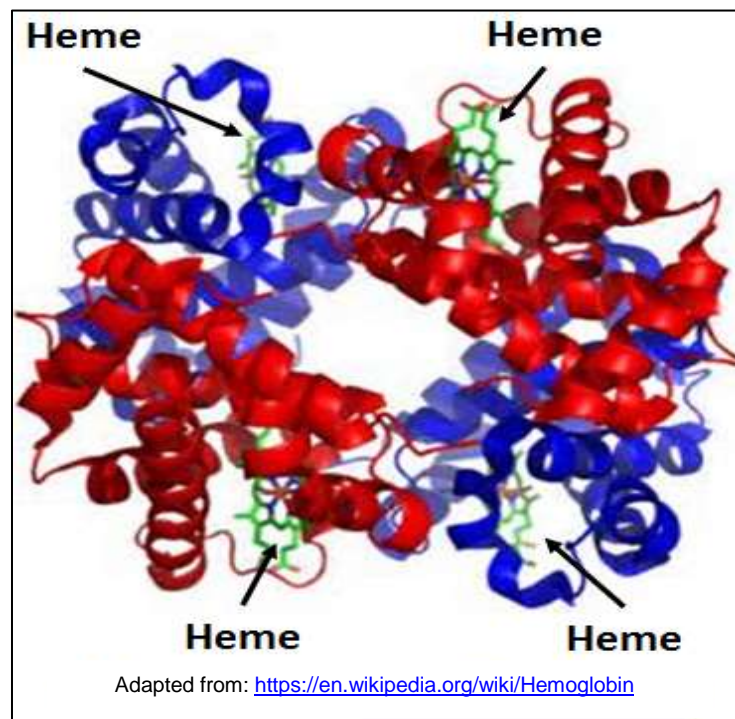

E. Some proteins require prosthetic Groups to be biologically active

Hemoglobins exemplify another feature of the structure of many proteins. To be biologically active, globin polypeptides must associate with a *prosthetic group*, in this case a cyclic organic molecule called *heme*. At the center of each heme is the iron which reversibly binds oxygen. Hemoglobins are found in all kinds of organisms, from bacteria to plants and animals... even some anaerobic organisms. Other proteins must be bound to different metal ions (magnesium, manganese, cobalt...) to be biologically active.

CHALLENGE: In animals, hemoglobins serve a clear function – they bind and distribute the oxygen necessary for respiration. Can you imagine a reason why anaerobic organisms would have hemoglobin?

F. Protein domains, motifs, and folds in protein structure

The structures of two different proteins shown below share a common domain (maroon).



This so-called *PH domain* is involved in binding a signal molecule, phosphatidyl-inositol triphosphate. The implication is that there are two cell signaling pathways, allowing a cell to respond to two different signals can lead to the same cellular response (albeit under different conditions and probably at different times).

Proteins are frequently described as consisting of several kinds of distinct sub-structures:

1. A *structural domain* is an element of the protein's overall structure that is stable and often *folds* independently of the rest of the protein chain. Many domains are not unique to the protein products of one gene, but instead appear in a variety of proteins.
2. Genes that encode these related proteins often belong to *gene families* (very closely related in evolution) or *gene superfamilies* (sharing domains but otherwise less related). Domains often are named and singled out because they figure prominently in the biological function of the protein they belong to, e.g., *the calcium-binding domain* of [calmodulin](#). Because they are independently stable, domains can be "swapped" by genetic engineering between one protein and another to make *chimeras*.
3. Structural and sequence *motifs* refer to smaller regions of protein three-dimensional structure or amino acid sequence that were found in a large number of different proteins. Motifs refer more to recognizable structures than to chemical or biological function.
4. [Supersecondary structure](#) refers to a combination of secondary structure elements, such as *beta-alpha-beta* units or the *helix-turn-helix motif*. Some of them may be also referred to as structural motifs. You can "google" these terms to find examples.
5. A *protein fold* refers to a general aspect of protein architecture, like *helix bundle*, *beta-barrel*, *Rossmann fold* or different "folds" provided in the [Structural Classification of Proteins](#) database. Click [Protein Folds](#) to read more about fold structures.

Despite the fact that there are about 100,000 different proteins expressed in eukaryotic systems, there are many fewer different domains, structural motifs and folds. This implies that the evolution of protein function has occurred at least as much by the recombinatorial exchange and sharing of DNA segments of genes encoding protein domains and motifs as by base substitutions in DNA changing the primary structure of polypeptides.

CHALLENGE: After reading this section (and if necessary, doing a bit of extra research), provide additional examples of different proteins that share a domain or motif, and why shared domains and motifs might have been selected in evolution.

III. View 3D Animated Images of Proteins in the NCBI Database.

We can't see them with our own eyes, but viewed by X-Ray diffraction, proteins exhibit exquisite diversity. Get an X-Ray's eye, three-dimensional animated view of protein structures at *National Center for Biological Information's* Cn3D database. Here's how:

- Download the Cn3D-4.3.1_setup file (for Windows or Mac) from the following link: <http://www.ncbi.nlm.nih.gov/Structure/CN3D/cn3dinstall.shtml>. The software will reside on your computer and will activate when you go to a macromolecule database search site.
- Click http://www.ncbi.nlm.nih.gov/Structure/MMDB/docs/mmdb_search.html to enter the protein structure database:

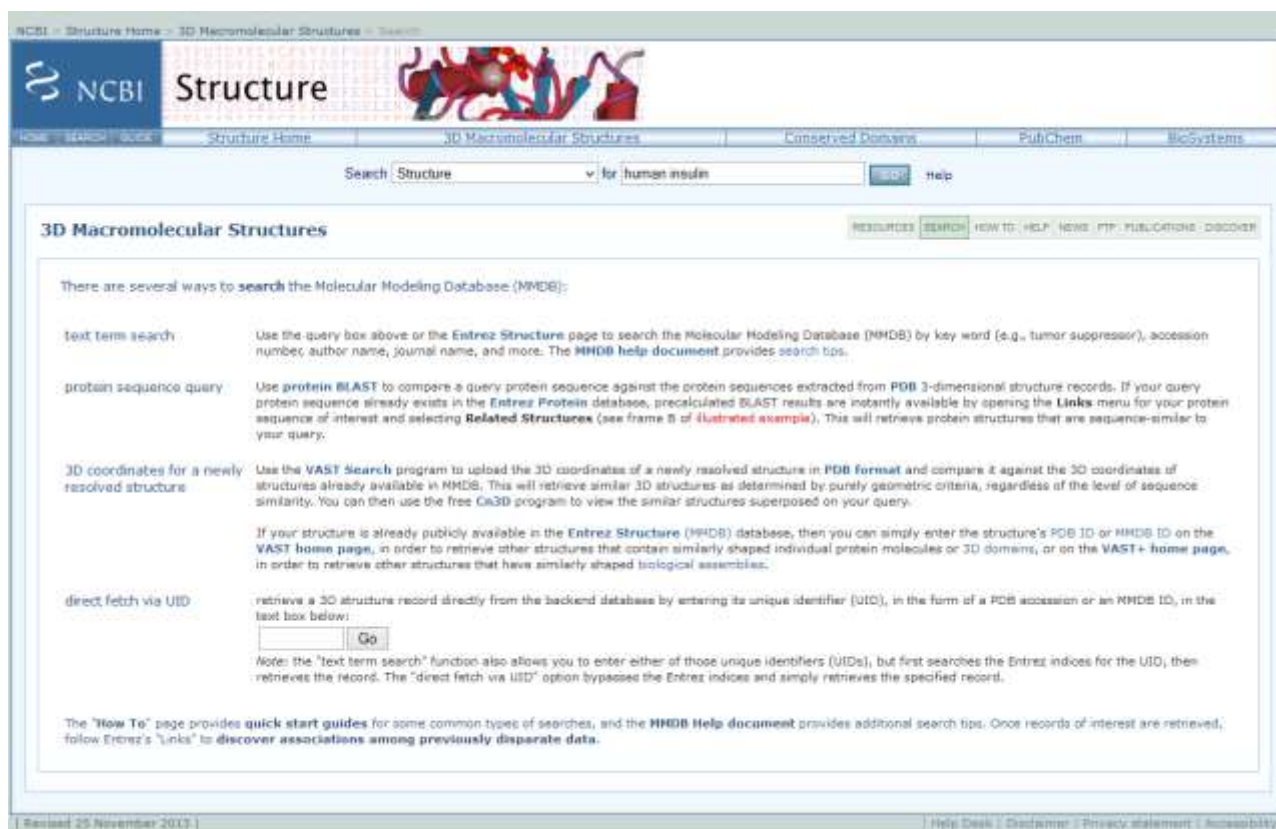

The screenshot displays the NCBI Structure website interface. At the top, there is a navigation bar with the NCBI logo and the word "Structure". Below this, a search bar contains the text "Structure" and "for human insulin". The main content area is titled "3D Macromolecular Structures" and provides several search methods for the Molecular Modeling Database (MMDB):

- text term search:** Use the query box above or the Entrez Structure page to search the Molecular Modeling Database (MMDB) by key word (e.g., tumor suppressor), accession number, author name, journal name, and more. The [MMDB help document](#) provides search tips.
- protein sequence query:** Use protein BLAST to compare a query protein sequence against the protein sequences extracted from PDB 3-dimensional structure records. If your query protein sequence already exists in the Entrez Protein database, precalculated BLAST results are instantly available by opening the **Links** menu for your protein sequence of interest and selecting **Related Structures** (see frame 8 of [Illustrated example](#)). This will retrieve protein structures that are sequence-similar to your query.
- 3D coordinates for a newly resolved structure:** Use the VAST Search program to upload the 3D coordinates of a newly resolved structure in PDB format and compare it against the 3D coordinates of structures already available in MMDB. This will retrieve similar 3D structures as determined by purely geometric criteria, regardless of the level of sequence similarity. You can then use the free Cn3D program to view the similar structures superposed on your query. If your structure is already publicly available in the Entrez Structure (MMDB) database, then you can simply enter the structure's PDB ID or MMDB ID on the [VAST home page](#), in order to retrieve other structures that contain similarly shaped individual protein molecules or 3D domains, or on the [VAST+ home page](#), in order to retrieve other structures that have similarly shaped biological assemblies.
- direct fetch via UID:** retrieve a 3D structure record directly from the backend databases by entering its unique identifier (UID), in the form of a PDB accession or an MMDB ID, in the text box below:

Note: the "text term search" function also allows you to enter either of those unique identifiers (UIDs), but first searches the Entrez indices for the UID, then retrieves the record. The "direct fetch via UID" option bypasses the Entrez indices and simply retrieves the specified record.

At the bottom of the page, there is a footer with the text: "The 'How To' page provides quick start guides for some common types of searches, and the [MMDB Help document](#) provides additional search tips. Once records of interest are retrieved, follow Entrez's 'links' to discover associations among previously disparate data."

- The search example shown above for human insulin takes you to this link: <http://www.ncbi.nlm.nih.gov/structure/?term=human+insulin&SITE=NcbiHome&submit.x=12&submit.y=12> The website is shown below:

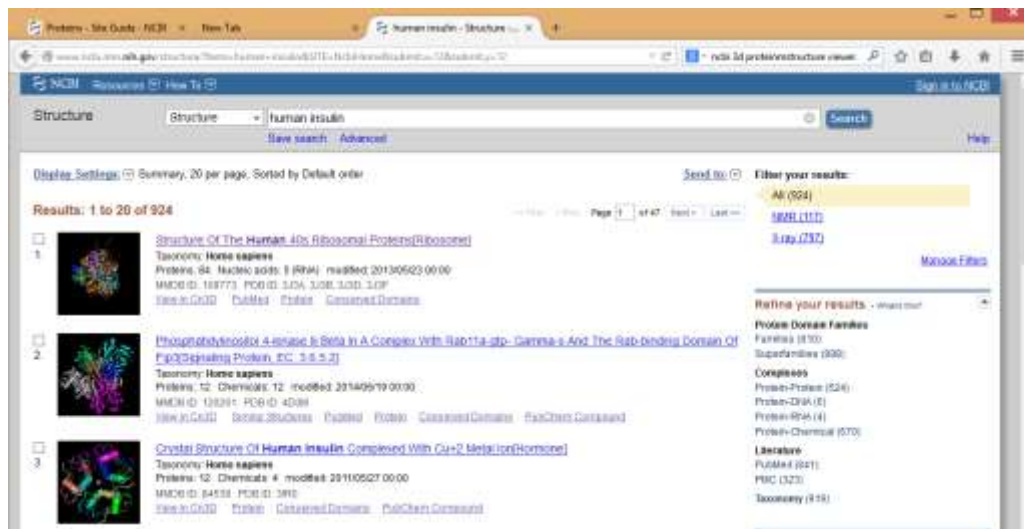

- Click *View in Cn3D* for the desired protein. For human insulin see this:

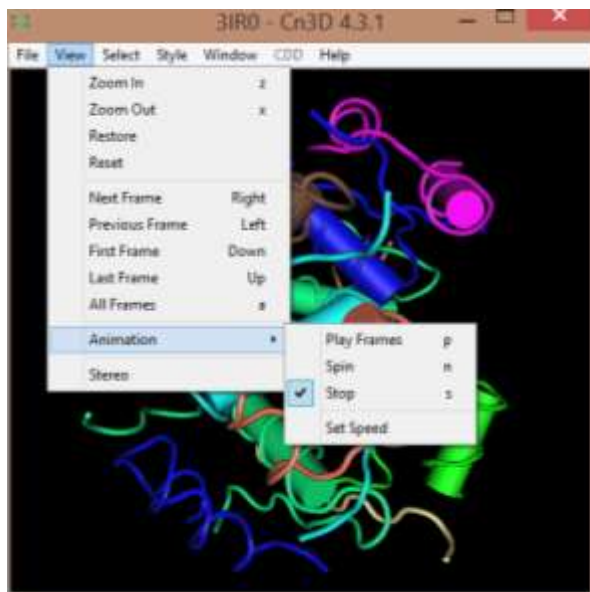

- To rotate the molecule, click *View* then *Animation*, then *Spin...* and enjoy!

Key Words and Terms

alpha helix	hydrophobic interactions	quaternary structure
amino acid residues	levels of protein structure	random coil
amino acid α-carbon	orders of protein structure	recombinatorial exchange
beta barrel	peptide bonds	salt bridges
beta sheet	peptide linkages	secondary structure
chaperones	phosphorylation	sequence motifs
configuration	pleated sheet	side chains
disulfide bonds	polypeptide backbone	structural domain
functional groups	primary structure	structural motif
glycosylation	prion	sulfhydryl groups
helix-turn-helix motif	protein folding	tertiary structure

Chapter 4: Bioenergetics

Thermodynamics (Free Energy, Enthalpy and Entropy), Chemical Energy, Open vs. Closed Systems



<http://2.bp.blogspot.com/-JJjVIBWVlQ/UwSswzVXjVI/AAAAAAAAAN-M/cqcnNe-WWB4/s1600/energy+cats.jpg>

I. Introduction

The Laws of Thermodynamics describe the flow and transfer of energy in the universe. The 3 Laws are:

1. *Energy can neither be created nor destroyed*
2. *Universal entropy (disorder) is always increasing.*
3. *Entropy declines with temperature -as temperatures approach absolute zero, so does entropy.*

In living systems we do not have to worry about the 3rd law. But as we'll see, equations for energy exchange in living systems reflect the temperature dependence of entropy changes during reactions. In this chapter we'll look how we come to understand basic thermodynamic principles and how they apply to living systems; for an excellent discussion of how basic thermodynamic principles apply to living things, see: Lehninger AL (1971) *Bioenergetics: The Molecular Basis of Biological Energy Transformation*. Benjamin Cummings, San Francisco).

First we'll look at different kinds of energy and how redox reactions govern the flow of energy through living things. Then we'll try to understand some simple arithmetic statements of the Laws of Thermodynamics for *closed systems* and see how they apply to chemical reactions conducted under so-called standard conditions. Finally, since there really is no such thing as a closed system, we'll look at energetics (energy transfers) in open systems.

Learning Objectives

When you have mastered the information in this chapter and the associated VOPs, you should be able to:

1. explain the difference between *energy transfer* and *energy transduction*
2. compare and contrast *different kinds of energy* (e.g., *mass, heat light, etc.*)
3. derive the algebraic relationship between *free energy, enthalpy* and *entropy*
4. predict changes in free energy based on changes in the concentrations of reactants and products in closed systems and open systems
5. explain the reciprocal changes in universal free energy and entropy
6. articulate the difference between reactions that are *exothermic, endothermic, exergonic, and endergonic*
7. predict whether a biochemical reaction will release free energy if it is exothermic, and if so, under what conditions
8. distinguish between *chemical equilibrium* and *steady-state* reaction conditions
9. compare and contrast the same reaction under conditions where it is endergonic and conditions where it releases free energy

Voice-Over PowerPoint Presentations

[Bioenergetics Part 1](#)

[Bioenergetics Part 2](#)

II. Kinds of Energy

We can easily recognize different kinds of energy around us like **heat, light, electrical, chemical, nuclear, sound**, etc... and you probably know that energy is measurable (calories, joules, volts, decibels, quanta, photons...). Even mass is a form of energy, as you may recall from Albert Einstein's famous $e=mc^2$ equation (the *law of relativity*).

CHALLENGE: Nuclear energy arises out of this realization. Explain this in a sentence or two.

The problem in thinking about thermodynamics is that the universe is big and there are too many kinds of energy to contemplate at once! Let's try to simplify by imagining only two kinds of energy in the universe: **potential energy** and **kinetic energy**. The best known example of these two kinds of energy may be water above a dam, representing potential energy. When the water flows over the dam, the potential energy is released as kinetic energy. In the old days the kinetic energy of flowing water could be converted into the kinetic energy of a millstone to grind flour or other grains. These days, if water flows through a hydroelectric dam, the water's kinetic energy can be converted (*transduced*) into

electricity. In this simple view, heat (molecular motion), electricity (a current of electrons), sound (waves), and light (waves OR moving 'particles') are different forms of kinetic energy. The energy of mass, or its position in the universe is potential energy. Thus chemical energy, e.g., the energy in a mole of ATP is potential energy. Physicists talk a lot about potential and kinetic energy flow and conversion.

An equally simple but more general way to conceptualize energy is as **useful vs. useless**. This concept led directly to the arithmetic formulation of the thermodynamic laws. In this binary way of thinking about energy, useless energy is **entropy**, while useful energy can be any of the other forms of energy (potential or kinetic).

We will see that the key to understanding bioenergetics is to understand the difference between closed systems and open systems in the universe. Systems that reach **equilibrium** (like biochemical reaction in a test tube) are considered **closed systems**. Closed systems are artificial, possible only in a lab where one can restrict and measure the amount of energy and mass getting into or escaping the system. Cells, living things in general, and basically every reaction or event in the rest of the universe (outside the lab) are **open systems** that readily exchange energy and mass with their surroundings.

With this brief introduction, we can put ourselves in the position of early scientists trying to understand energy flow in the universe. Let's look at the thermodynamic laws and how they apply to living systems (bioenergetics). As we go through this exercise, let's remember that the **Laws of Thermodynamics** can be demonstrated because all kinds of energy can be measured (heat in calories or joules, electricity in volts, light in quanta, matter in units of mass, etc.).

III. Deriving simple energy relationships

A. Energy in the Universe: the Universe is a **Closed System**

Consider an event, or happening. We can agree, I think, that when stuff happens, participants in the happening go from an unstable state to a relatively more stable state. In a simple example you carrying a bag of marbles and you accidentally tipped over the bag. The marbles would fall to the floor and roll and spread out, eventually coming to a stop. At that point, the marbles are in a more stable state than they were when you were holding the bag. If asked, you would say that gravity made the marbles fall from the bag. That is certainly true. But couldn't you also agree that the drive to greater stability is what made the marbles fall? In fact, it is indeed the drive to greater stability that makes things happen! This is the essence of the 2nd law of thermodynamics - all universal energy transfer events occur with an increase in stability..., that is, an increase in entropy.

Let's accept that the tendency of things go from unstable to more stable is a natural, rational state of affairs..., like those marbles on the floor, or a messy bedroom with clothes strewn about. So, we can say that messy and disordered is more stable than ordered. Of course marbles dropping or clothing going from folded and hung onto the floor releases energy (potential energy) as they fall (kinetic energy). If you don't believe that this release of energy is real, just think of how much energy you will need to pick up the marbles and fold your clothes (after laundering them of course!). Let's model the flow of energy in the universe that is consistent with thermodynamic laws.

If energy can be neither created nor destroyed, a simple statement of the First Law could be:

$$E_{\text{universal}} = E_{\text{light}} + E_{\text{heat}} + E_{\text{electrical}} + E_{\text{mass}} \dots$$

The equation sums up the different kinds of energy in the universe. Look at it this way:

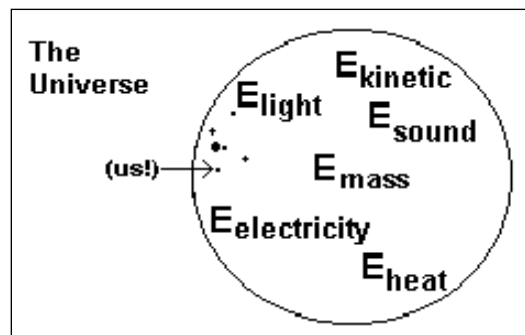

Energy cannot get in or out of the universe. It can only be transferred between parts or converted from one form to another. It follows then that $E_{\text{universal}}$ is the sum of all kinds of energy in the universe, and must be a constant, or:

$$E_{\text{light}} + E_{\text{heat}} + E_{\text{electrical}} + E_{\text{mass}} + \dots = \text{a constant}$$

This is a statement of the First Law. Click <http://youtu.be/qPgZnmVFv8g> for a YouTube animation of the First law in action!

If we go with the simpler binary notion of useful and useless energy, our equation can be re-written as the sum of just two kinds of energy in the universe:

$$E_{\text{universal}} = G_{\text{universal}} + TS_{\text{universal}}$$

where G is useful energy ("Gibbs" free energy), S is useless energy (entropy), and T is absolute temperature (included because of the 3rd law).

This is also a statement of the First Law. Here is our revised circle diagram:

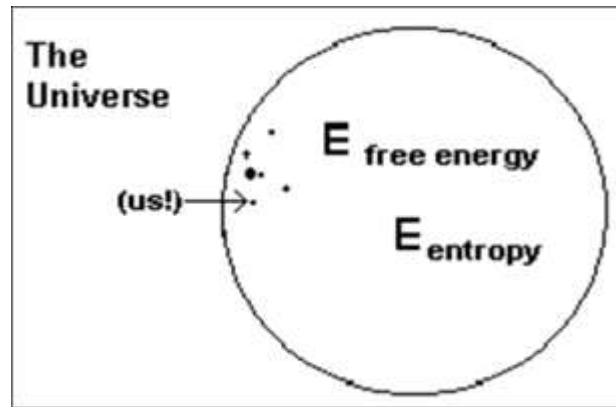

By the way, segregating things and concepts into circles is a way of logically viewing relationships between them. This approach was first formalized by John Venn in the late 19th century. You'll frequently see attempts to clarify relationships in what have become known as *Venn* diagrams. The ones shown here are very simple; "Google" Venn Diagrams to see more complex examples showing what happens when universes overlap!

In this binary energy model, it follows that as universal entropy increases, free energy in the universe must decrease:

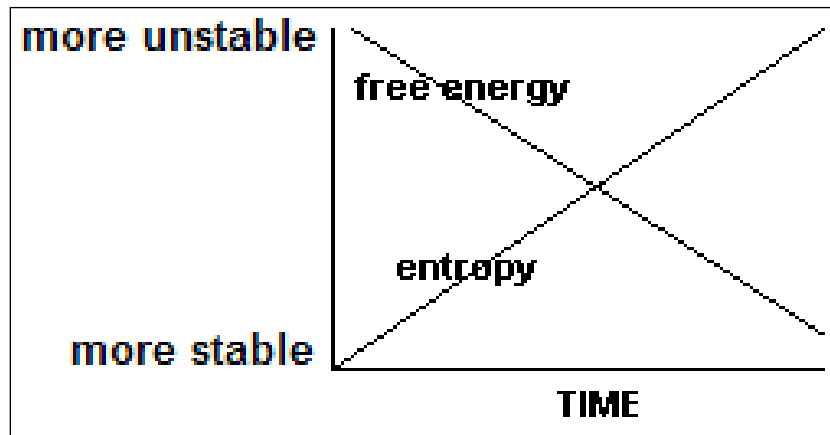

Free or 'potentially useful' energy is higher in more ordered, complex and therefore relatively unstable systems. Free energy will be released spontaneously (without help) from unstable, ordered systems.

B. Energy is Exchange between Systems in the Universe

If we can measure the amount of energy put into or removed from **a system within the universe**, we can write a more useful equation to follow the transfer of energy between a system and its surroundings:

$$\Delta H = \Delta G + T\Delta S$$

where ΔH = change (Δ) in enthalpy, i.e., as energy entering/leaving the system in units of heat energy); ΔG = change in free energy; ΔS = change in entropy, T = absolute temperature ($^{\circ}\text{K}$). Note that changes in entropy are often referred to as heat lost in a reaction or physical event, and can therefore be easily confused with enthalpy change! While it's true that much of the increase in entropy that occurs in living things is indeed in the form of random molecular motion, or heat, remember that not all heat is entropic. If entropy is "useless" energy, remember that heat has its uses! That's why it is more interesting (and accurate!) to think of energy, and how energy transfer occurs, in terms of changes in enthalpy, free energy and entropy. If you need to, please revisit the *Bioenergetics* VOP for clarification.

According to this equation $\Delta H = \Delta G + T\Delta S$, interacting systems in our universe would seem to be *closed systems*. Accordingly, if energy is put into or removed from the system (ΔH), it will be exactly balanced by increases and/or decreases in the other two terms ($\Delta G + T\Delta S$). We refer to these systems as closed systems *not* because they are really closed, but because we can isolate them well enough to account for energy flow into and out of the system.

For any algebraic equation with three variables, if you know two of the values, you can calculate the third! Here is a simple situation to illustrate the point: If I put a liter of water on a burner and light the flame the water gets hot. If the temperature of the liter of water rises by 1°C , we know that it has absorbed 1000 calories (one Kcal, or one *food* Calorie) of the heat from the burner. Since energy interactions depend on different physical conditions, such as temperature and air pressure, we need to standardize those conditions when conducting experiments that measure energy changes in those isolated ("closed") systems. For more on how standardizing these physical parameters enables measuring energy change in chemical reactions (in fact, any energy exchange), click this YouTube link (<http://youtu.be/27B0D1uf8GM>)

Now let's apply the equation $\Delta H = \Delta G + T\Delta S$ to chemical reactions that occur in cells. Because most life on earth lives at sea level where the air pressure is 1 atmosphere and the temperature is in the 20's (Celsius), typical determinations of ΔH , ΔG , and ΔS are made under **standard conditions** where $T=298^{\circ}\text{K}$ (25°C), an atmospheric pressure of pressures of 1 atm, a constant pH of 7.0. In addition, measured energy values are corrected to be for molar quantities of reactants. Our equation for reactions under these standard conditions becomes: $\Delta H = \Delta G_0 + T\Delta S$, where ΔG_0 is the

standard free energy change for the reaction conducted in a *closed system* under standard conditions, ΔH is still the enthalpy change and ΔS is still the entropy change... but determined under unimolar and standard conditions.

But wait... what's this about *unimolar conditions*? That just means if you are burning glucose in a calorimeter, you would burn say 180 milligrams of the stuff and then multiply the calories released (ΔH) by 1000 to get how much heat would be released if you actually burned a whole mole (180 gm) of the stuff. So, what is the molecular weight of glucose? How much does a mole of glucose weigh? How much glucose was actually burned in the calorimeter, in moles? Now we are ready to consider examples of how we determine the energetics of reactions.

C. How is Enthalpy Change (ΔH) Determined?

ΔH for a chemical reaction can easily be determined by conducting the reaction under standard conditions in a *bomb calorimeter*. Food manufacturers determine the calorie content of food using a bomb calorimeter. As the reaction takes place (in the beaker in the illustration) it will either release or absorb heat. The water in the calorimeter jacket will either get warmer or cooler, as measured by the thermometer. A reaction that releases heat as it reaches equilibrium is **exothermic** that by definition will have a negative ΔH . For example, if the package says that a chocolate bar has 90 Calories, then the bar will generate 90 kilocalories of heat when it is burned in the calorimeter. (1 Calorie, with a capital C = 1000 calories, or 1 Kcal; 1 calorie is the energy needed to raise a gram of water by 1°C). On the other hand, some chemical reactions actually absorb heat. Just take a hospital cold-pack, squeeze it to get it going and toss it in the calorimeter. You can watch the temperature in the calorimeter drop as the pack absorbs heat from the surroundings! Such reactions are defined as **endothermic**. A bomb calorimeter schematic is shown below.

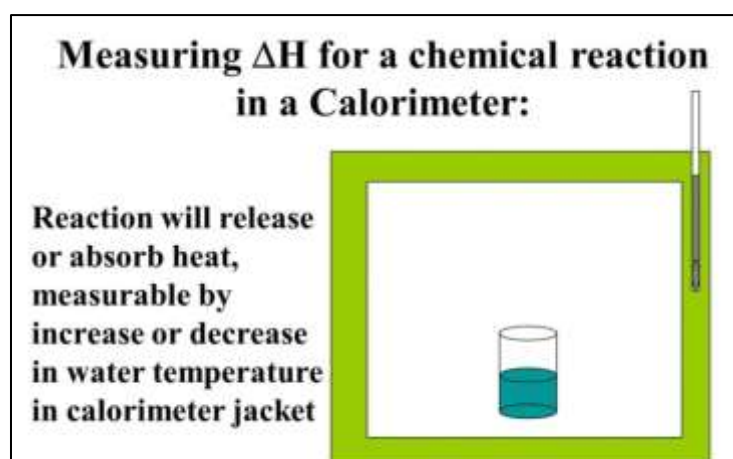

For an animated description of calorimetry, click the link at <http://youtu.be/cpps2CZ0aA4>.

OK, so we can determine the value of one of the energy parameters... we need to know at least one other, either ΔG_0 or ΔS before the equation $\Delta H = \Delta G_0 + T\Delta S$ becomes useful.

D. How is Standard Free Energy change (ΔG_0) Determined?

The standard free energy change, ΔG_0 , is **directly proportional** to the concentrations of reactants and products of a reaction conducted to completion (i.e., *equilibrium*) under standard conditions. So to determine ΔG_0 we need to be able to measure the concentration of reactants and reaction products before and after a chemical reaction (i.e., when the reaction reaches equilibrium). For example, take the following generic chemical reaction:



It turns out that ΔG_0 is related to the equilibrium concentrations of A, B, C and D by the following equation:

$$\Delta G_0 = -RT \ln K_{eq} = RT \ln \frac{[C]^2[D]}{[A]^2[B]}$$

This is the **Boltzman equation**, where **R**= the gas constant (1.806 cal/mole-deg), **T** = 298°K and **Keq** is the **equilibrium constant**. As you can see, the Keq for the reaction is the ratio of the product of the concentrations of the products (raised to their stoichiometric powers) to the product of the concentrations of the reactants raised to *their* stoichiometric powers.

The Boltzman equation allows us to calculate ΔG_0 , the *standard free energy change* for a reaction, provided you can determine the equilibrium concentrations of reactants and products in a chemical reaction. Consider the following generic chemical reaction:



If the ΔG_0 is a negative number, the reaction releases free energy and is defined as **exergonic**. If the ΔG_0 is a positive number, the reaction absorbs free energy and is defined as **endergonic**.

CHALLENGE: What more can you say about the concentration of reactants and products at equilibrium in an exergonic reaction?

E. Working an Example Using these Equations for Closed Systems

Consider the following reaction:

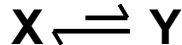

Is this reaction *endergonic* or *exergonic*? How would you know, even without determining ΔG_0 ? You can also do the math: after measuring (*assaying*) the concentrations of the reactants and products for this reaction, they are found to be:

$$[X] = 2,500 \text{ cal/Mole}; [Y] = 500 \text{ Kcal/Mole}$$

Use the Boltzmann equation to calculate the standard free energy for this reaction. What is the **Keq** for this reaction? What is the ΔG_0 for the reaction? If you did not come up with a Keq of 0.2 and an absolute value for the standard free energy $|\Delta G_0|$ of 866.2 cal/mole, re-calculate or collaborate with a classmate. Based on the actual (*not the absolute*) value of ΔG_0 is this reaction endergonic or exergonic?

Let's assume that when the reaction is conducted in a bomb calorimeter, the reaction proceeded to equilibrium with a $\Delta H = 2800$ calories/Mole. Together with the *enthalpy change*, it is now possible to calculate ΔS for a reaction. Assume that the ΔH is 1,800 Kcal/mole and based on your determination for ΔG_0 , calculate the ΔS for the reaction. At equilibrium, did the reaction proceed with an increase or decrease in entropy under standard conditions?

F. Actual Free Energy Change in Open Systems

Later, we will be discussing the flow of energy through living things, from sunlight to chemical energy in nutrient molecules to the extraction of this chemical energy as ATP and heat, to the performance of all manner of cellular work. Cells are *open systems*, able to exchange mass and energy with their environment, so the conditions under which cells conduct their biochemical reactions are decidedly *non-standard*. For one thing, open systems do not reach equilibrium. Cells are constantly exchanging energy and matter with their environments. In addition, diverse organisms live under very different atmospheric conditions and maintain different body temperatures (e.g., your cat has a higher body temperature than you do!). By definition then, *open systems do not reach equilibrium*. But if the rate of input of energy (and matter) is equal to the rate of output of energy (and matter) for the system (think of a biochemical pathway, like glycolysis), we say that the system has reached a *steady state*.

CHALLENGE: Since matter is just another form of energy, why is it singled out when speaking of biological systems as open?

Since reaction rates can change (and are in fact regulated in cells) the steady state can change. Be sure to view the recorded lectures for a full explanation of the properties of the steady state of open systems.

Fortunately, we have worked out the equation that allows us to determine the free energy changes in open systems...

For our chemical reaction $2A + B \rightleftharpoons 2C + D$, the equation would be:

$$\Delta G' = \Delta G_0 + RT \ln \frac{[C]_{ss}^2 [D]_{ss}}{[A]_{ss}^2 [B]_{ss}}$$

Here, $\Delta G'$ is the *actual free energy change* for the reaction in the open system, ΔG_0 is the standard free energy change for the same reaction under standard conditions in a closed system, R is the gas constant (1.806 cal/mole-deg), T is the temperature in which the reaction is actually occurring, and the subscript 'ss' designates reactant and product concentrations as those under *steady state* conditions. To determine the actual free energy of a biochemical reaction in a cell (in fact in any living tissue), all you need to know are the ΔG_0 for the reaction, the steady state concentrations of reaction components in the cells/tissues, and the absolute T under which the reactions are occurring.

In the next chapter, we will use the reactions of the glycolytic pathway to exemplify the energetics of open and closed systems. Pay careful attention to how the terminology of energetics is applied to describe energy flow in *closed vs. open systems*.

Some iText & VOP Key Words and Terms

Laws of Thermodynamics	exergonic	useless energy
energy	endergonic	Law of Conservation
entropy	standard free energy	Gibbs free energy
bioenergetics	actual free energy	order vs. entropy
energy transfer	calories	standard conditions
energy transduction	volts	calorimeter
mass	$e=mc^2$	Keq
free energy	decibels	equilibrium constant
enthalpy	chemical energy	chemical equilibrium
closed systems	electricity	Boltzman equation
open systems	ATP	open system properties
exothermic	light	steady state
endothermic	useful energy	gas constant

Chapter 5: Enzyme Catalysis and Kinetics

Mechanism of Enzyme Catalysis, Induced Fit, Activation Energy, Determining and Understanding Enzyme Kinetics

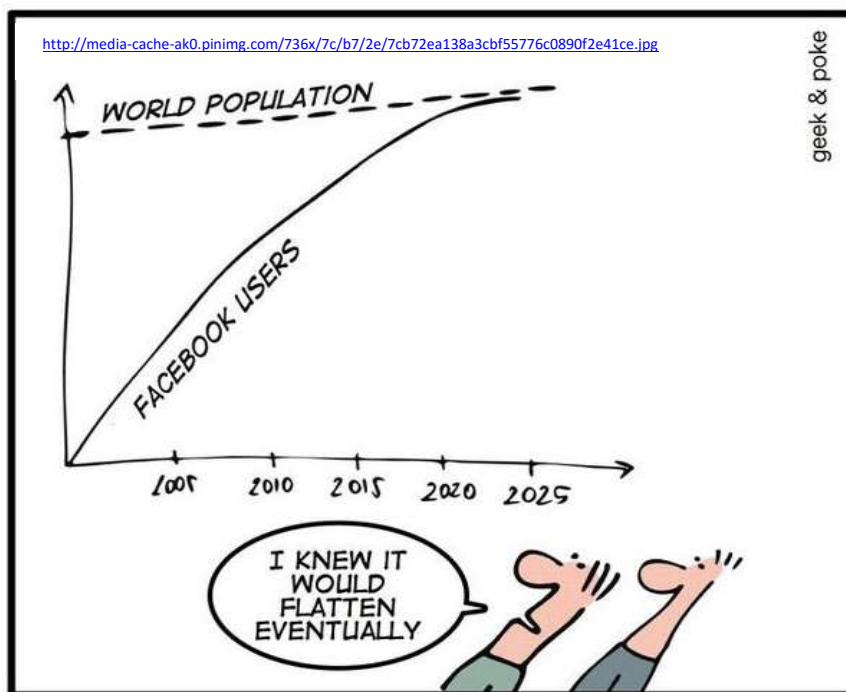

I. Introduction

Enzymes are proteins that function as catalysts. Like all catalysts they accelerate chemical reactions. In this chapter we look at the mechanism of action of enzymes based on allosteric change (*induced fit*) and energetics (changes in *activation energy*), and how enzymes work in open and closed (experimental) systems. We'll see what happens at an *active site* and how enzymes are change shape as they are regulated. We will then look at how we measure the speed of enzyme catalysis, and why understanding enzyme kinetics is important. Finally, we look at details of the classic enzyme kinetic data of Leonor Michaelis and Maud Menten, focusing on the significance of the K_m and V_{max} values obtained from kinetic studies.

The most important property of enzymes is that they undergo shape/conformational change during catalysis, and in response to cellular metabolites that indicate the biochemical status of the cell. These metabolites are often reactants (*substrates*) or products of other enzyme-catalyzed reactions in the same biochemical pathway as the enzyme being regulated.

The table below compares inorganic catalysts and enzymes.

Enzymes vs Inorganic Catalysts	
Inorganic Catalysts	Enzymes
e.g., Ni, Pt, Ag, etc.	e.g., pepsin, trypsin, ATP synthase, ribonuclease, etc.
increase rxn rate	increase rxn rate
unchanged at end of rxn	unchanged at end of rxn
non-specific	highly specific
rigid, inflexible	flexible - can undergo <i>allosteric</i> change...
cannot be regulated	can be regulated

The differences are color-highlighted and explain how enzymatic activity can be regulated in ways that inorganic catalysis cannot.

Before we begin our discussion here, remember that chemical reactions are said to be reversible, by definition. The action of catalysts, either inorganic or organic, depends on this concept of reversibility.

CHALLENGE: Either now, or when you are done reading this chapter, see if you can explain the relationship between catalysis and the inherent reversibility of chemical reactions in your own words.

Voice-Over PowerPoint Presentations

[Enzymes: Catalysis](#)

[Enzymes: Kinetics Part 1](#)

[Enzymes: Kinetics Part 2](#)

Learning Objectives

When you have mastered the information in this chapter and the associated VOPs, you should be able to:

1. compare and contrast the properties of *inorganic* and *organic* catalysts
2. explain why *catalysts do not change equilibrium concentrations* of a reaction conducted in a closed system

3. contrast the roles of different *allosteric effectors* in enzymatic reactions
4. define *activation energy* and compare the activation energies of catalyzed and uncatalyzed reactions
5. explain how an RNA molecule can function as an enzyme (*ribozyme*)
6. discuss how an enzyme's *active site* and *allosteric site* interact
7. relate enzyme kinetic equations to basic chemical rate equations
8. distinguish between V_{max} and K_m in the equation for Michaelis-Menten enzyme kinetics
9. interpret enzyme kinetic data and the *progress of an enzyme-catalyzed reaction* from this data

II. Enzymes

Their large size and exquisite diversity of structure makes enzymes highly specific catalysts. And because they can be deformed by interaction with other molecules, they can be regulated. As much as catalysis itself is required to insure the efficiency of biochemical reactions in the cell, so is this *regulation*. The molecular flexibility of enzymes is required so that cells can control the rates and even the direction of biochemical reactions and pathways. Almost no chemical reaction occurs in a that is not directly the result of enzyme catalysis, from the digestion of nutrients in your mouth, stomach and small intestines to pretty much every chemical reaction inside your cells [check out Kornberg A (1989) Never a Dull Enzyme. Ann. Rev. Biochem. 58:1-30].

Most enzymes are proteins, but some RNA enzymes have also been identified (*ribozymes*, an example being a region of ribosomal RNA that participates in protein synthesis) Enzymes are generally soluble in or outside cells while a few are bound to membranes or are part of other cellular structures, but in all cases they bind to soluble *substrates*.

The specificity of an enzyme results from the shape of the region of the molecule called the *active site*, which is dependent on the 3-dimensional arrangement of amino acids in and around the region. The active site is where reactants (called *substrates*) are bound and held in place on the enzyme while rapid bond rearrangements take place. Like many proteins, enzymes may also be bound to *prosthetic groups* or ions that contribute to the shape and activity of the enzyme.

In the last few decades enzymes have been put to commercial use. For example, you can find them in household cleaning products where they are included in detergents to digest and remove stains caused by fats and pigmented proteins. Enzymes that break down proteins are also added to meat tenderizers to hydrolyze proteins down to smaller peptides.

A. The Mechanisms of Enzyme Catalysis

We describe the action of biological catalysis in two ways. One takes into account structural features of the enzyme (active site shape, overall conformation, affinities of the enzyme for its substrates). The other consideration involves the energetics of enzyme action. Specifically, enzymes lower an inherent energy barrier to the chemical reaction. This barrier is called the *activation energy* of the reaction. As you may imagine, the so-called structure and energy considerations are not unrelated.

1. *Structural considerations of catalysis*

From a chemistry course, you may recall that the rate of an uncatalyzed reaction is dependent on the concentration of the reactants in solution. This is the *Law of Mass Action*, recognized in the 19th century. This Law makes two key assumptions:

- a) Chemical reactions eventually reach equilibrium, at which point the net rate of formation of reaction products is zero (i.e., the forward and reverse reactions occur at the same rate).
- b) At any given time following the start of the reaction, the rate of product formation is proportional to the concentrations of the reactants and products.

In practical terms, at the start of the reaction, since there are no products yet, the reaction rate is directly proportional to the concentration of the reactants. Take a simple reaction in which A & B are converted to C & D:

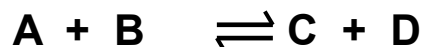

The simplified illustration of the *Law of Mass Action* is that at higher concentrations of A & B there are more reactant molecules in solution and therefore a greater likelihood that they will collide in an orientation that allows the bond rearrangements for the reaction to occur. Of course, as products accumulate over time, reactant concentrations decline and the rate of formation of C & D drops, now affected by product as well as reactant concentrations.

You may recognize the chemical rate equations from a chemistry course; these enable quantitation of reaction rates for the reaction above:

$$\text{Rate of formation of products (C \& D)} = k_1[A][B] - k_{-1}[C][D]$$

This rate equation recognizes that the reaction is reversible and therefore equal to the rate of the forward reaction ($k_1[A][B]$) minus that of the back reaction ($k_{-1}[C][D]$). The equation is valid (applicable) at any time during the reaction. k_1 and k_{-1} are rate constants for the forward and reverse reactions, respectively.

CHALLENGE: From the rate equation $(C \ \& \ D) = k_1[A][B] - k_{-1}[C][D]$, what will the rate be at the end of the reaction? Answer this question arithmetically and with a text explanation.

So how do catalysts work? Catalysts increase chemical reaction rates by bringing reactants together more rapidly than they would encounter each other by random molecular motion in solution. This is possible because catalysts have an *affinity* for their substrates. The attraction of reactants to inorganic catalysts is based on relatively weak, generic attractive forces so that a metallic catalyst like silver or platinum can attract molecules with the appropriate configurations (e.g., charge) where they bind to the surface of catalyst just long enough to undergo a chemical reaction.

Unlike inorganic catalysts, enzymes have evolved highly specific shapes with physical-chemical properties that typically attract only the substrates necessary for a particular biochemical reaction. It is therefore the active site of an enzyme that has the exquisitely selective *affinity* for its substrate(s). The affinities of enzyme active sites for substrates are manifold higher than those of inorganic catalyst surfaces for generic reactants. Hence enzymes can engage in much faster catalysis.

Early ideas of how substrate-enzyme interaction could be so specific involved the *Lock and Key* mechanism, illustrated below.

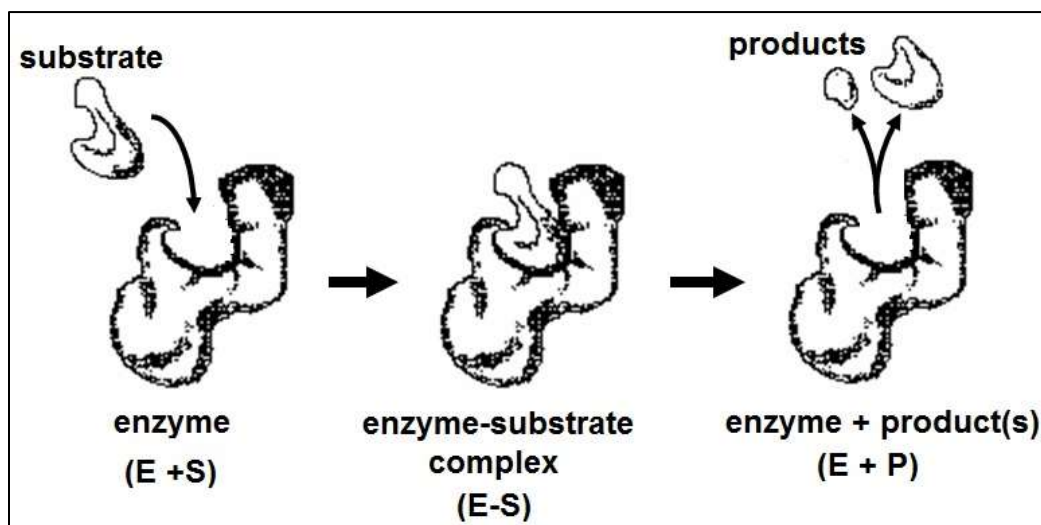

In this model the affinity of enzyme for substrate brings them together, after which the substrate uniquely fits into the active site like a key into a lock. Once in the active site the substrate(s) would undergo the bond rearrangements specific for the catalyzed reaction to generate products and regenerate an unchanged enzyme.

Subsequently the interaction of enzyme and substrate was examined using X-ray crystallography to determine the structure of the enzyme during catalysis. These studies revealed that upon binding to the substrate, the enzyme underwent a conformational (i.e., *allosteric*) change in the active site. The result is a better fit between enzyme and substrate.

These observations led to our understanding of the *Induced Fit* mechanism of enzyme action, illustrated below.

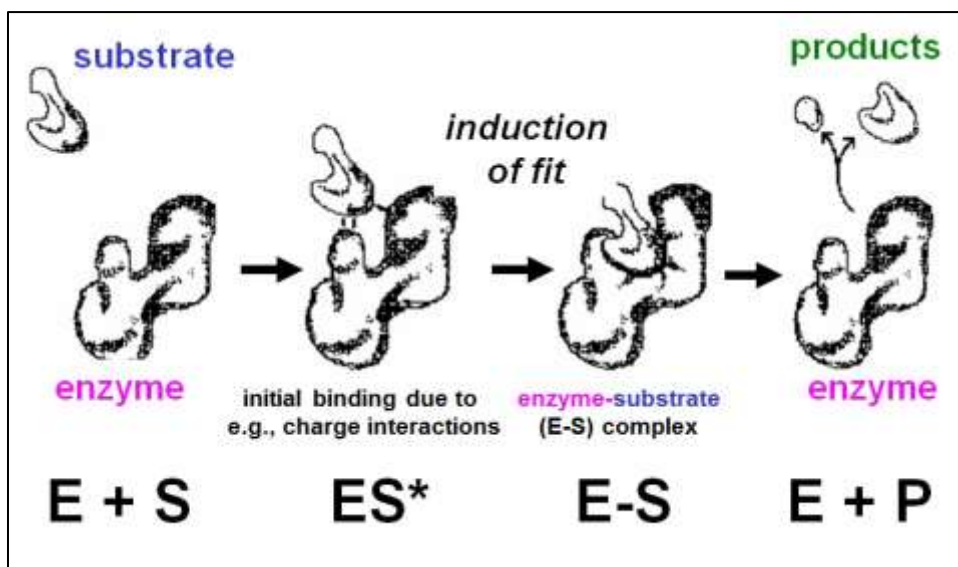

2. Energetic considerations of catalysis

Catalysts work by lowering the *activation energy* (E_a) for a reaction, thus dramatically increasing the rate of the reaction. Activation energy is essentially a barrier to getting interacting substrates together to actually undergo a biochemical reaction. Compare the random motion of substrates in solution that only occasionally encounter one another, and even more rarely bump into one another in just the right way to cause a reaction. This is why adding more reactants or increasing the temperature of a reaction can speed it up (i.e., by increasing the number of random molecular collisions). But living organisms do not have these options for conducting fast biochemical reactions.

Inorganic catalytic surfaces can attract reactants where catalysis can then occur. But the conformation (shape and charge configuration) of the active site of an enzyme attracts otherwise randomly distributed substrates even more strongly, making enzyme catalysis faster than inorganic catalysis. Again, cells do not have the option of using inorganic catalysts because they would affect many reactions indiscriminately... not a good way for cells to control metabolism! The advent of enzymes with their specificity and high rate of catalysis was a key event in *chemical evolution* required for the origin of life. As we saw, the initial binding of substrate to enzyme is followed by a subtle conformational change that induces a tight fit of substrates into the site, enabling catalysis. As a result, products of enzymatic reactions are formed faster than those catalyzed by inorganic catalysts, and of course much faster than the uncatalyzed reaction (millions of times faster!).

The energetics of catalysis of the simple reaction in which A & B are converted to C & D is shown below.

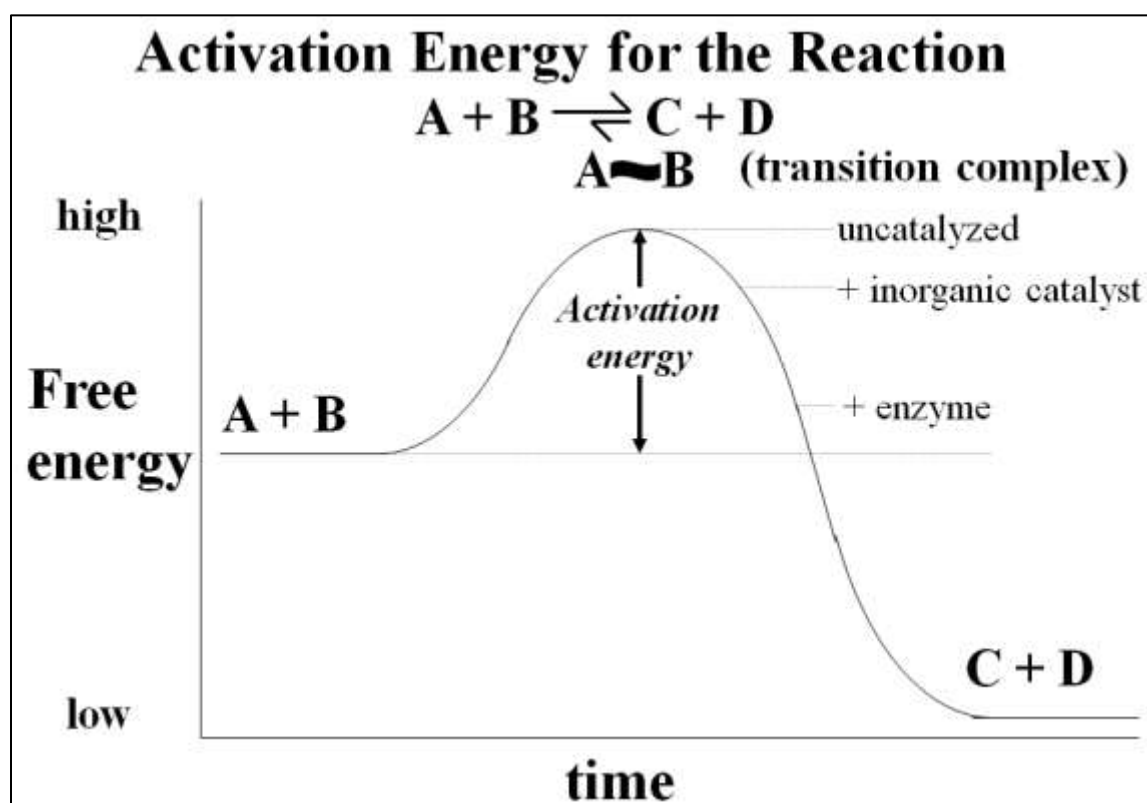

Conducted in a closed system, enzyme-catalyzed reactions reach their equilibrium more rapidly. As with all catalysts, enzymes are not consumed by the reactions they

catalyze, nor do they alter the equilibrium concentrations of reactants and products of these reactions. The roughly 4000 biochemical reactions known to be catalyzed in cells is undoubtedly an underestimate! But remember too, that we estimate that the human genome has only 20,000 to 25,000 different genes. What do you make of what appears to be an issue, or an inherent conflict between these two estimates?

B. Enzyme Regulation

We noted that some enzymes are regulated, which just means that factors in the cell can slow down or speed up their rate of catalysis. In this way the cell can respond quickly to metabolic needs reflected by the intracellular levels of these factors. Factors that slow down catalysis are called *inhibitors*. Those which speed up catalysis are called *activators*. In addition to responding to intracellular molecular indicators of the biochemical status of the cell, enzymes may be inhibited by drugs, poisons or changes in the chemical milieu (e.g. pH).

Most cellular reactions occur as part of biochemical pathways, so regulating a single enzyme can affect an entire pathway. For example, look at the pathway illustrated below.

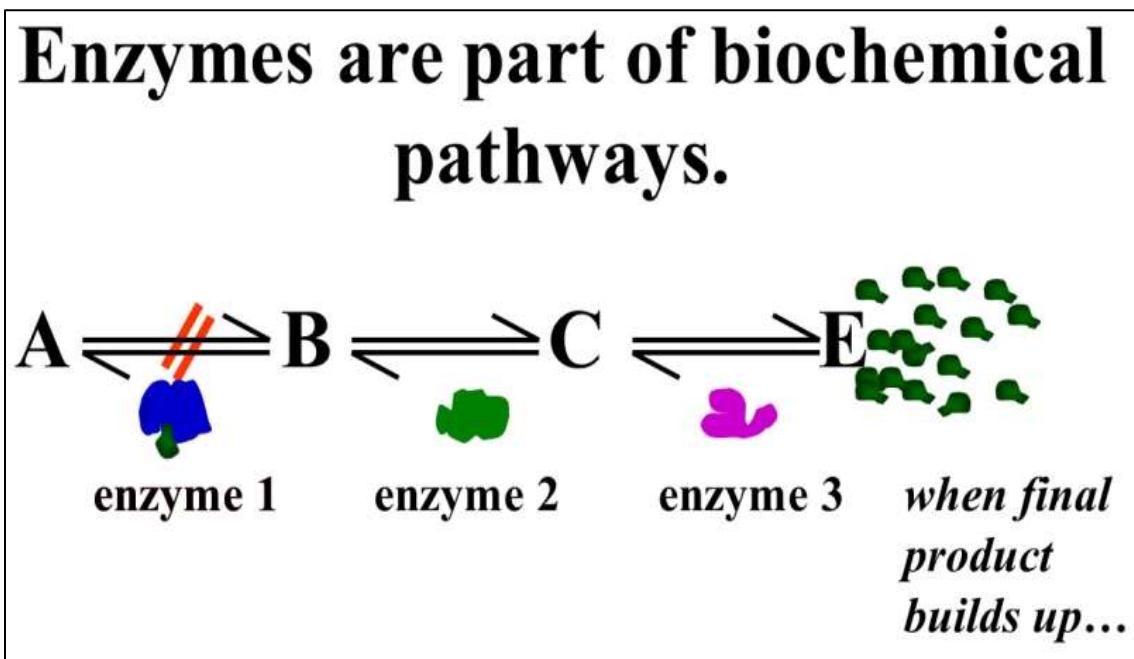

This pathway exists to produce substance **E**. Under normal conditions **E** would be consumed in some other series of metabolic reactions. But if the cell is meeting its

metabolic needs and no longer needs so much of substance **E**, it will accumulate in the cell. If there is an excess of **E** in the cell, some of it could bind to any one of the enzymes in the pathway shown, inhibiting this enzyme and slowing down the entire pathway. In this example, we can assume that inhibitory regulation of **enzyme 1** evolved to control the rate of production of substance **E**. This is a common mode of enzyme regulation, called *feedback inhibition*.

Enzymes can be regulated precisely because they are flexible and can be *bent out of shape* (or into shape for that matter!). When they accumulate in cells, some small metabolites become chemical information, signaling that they themselves are not needed by the cell, or that the cell must accelerate other processes related to the build-up of the metabolite.

The mechanism of allosteric regulation of enzyme activity is illustrated below.

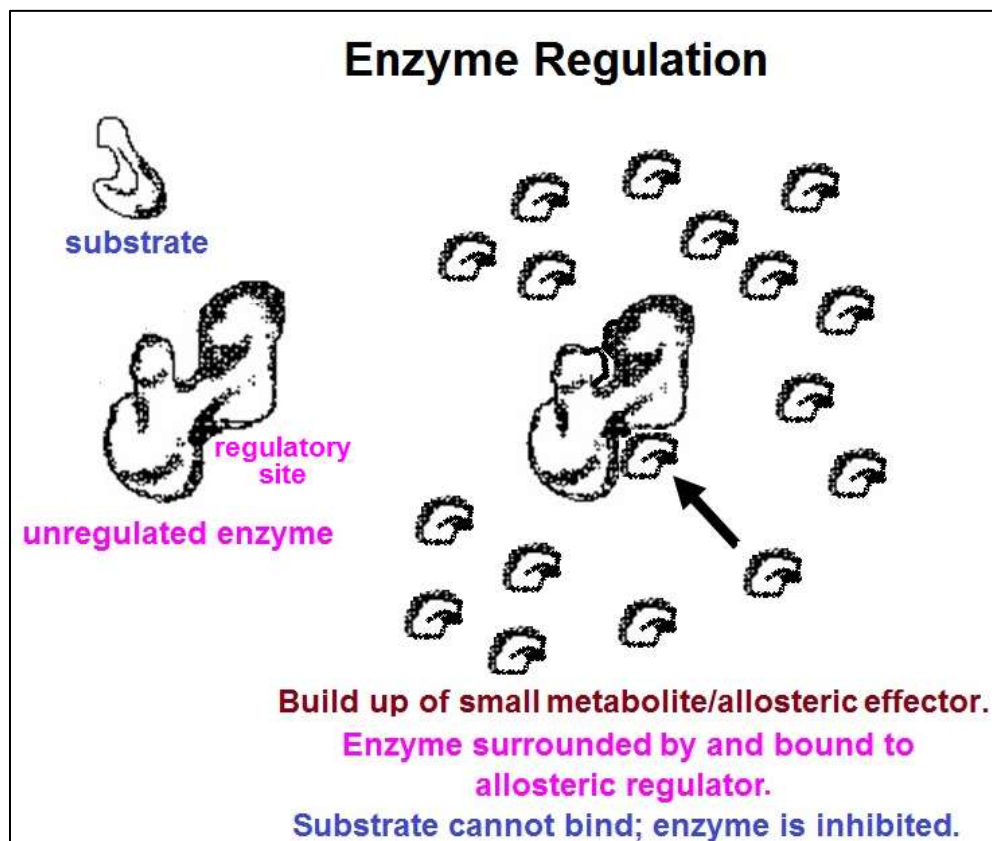

Whether an activator or an inhibitor of enzyme catalysis, regulatory molecules typically bind to enzymes at *regulatory sites*, ultimately causing allosteric changes in the active site. *Enzyme inhibition* will occur if this allosteric change reduces the affinity of enzyme

for substrate or the rate of the bond rearrangements after the substrate has entered the active site. *Enzyme activation* would occur if the allosteric effect is to increase this affinity and/or catalytic rate. We can understand rates of enzyme catalysis and how they change when allosterically regulated by determining *enzyme kinetics*.

By comparing kinetic data for each enzyme in a biochemical pathway, one can determine a standard *rate-limiting reaction* under a given set of conditions. If clinical tests reveal a patient that is producing too much or too little of an important metabolite, it might mean that a reaction in the biochemical pathway making the metabolite that was once rate limiting is not so any more. If clinical tests reveal that a patient is producing too much of the metabolite, then the catalytic rate of the normally rate-limiting enzyme has increased. On the other hand, if the patient is producing too little of the metabolite, then either the catalytic rate of the rate-limiting enzyme has decreased or the catalytic rate of another enzyme in the biochemical pathway has become rate limiting.

What might cause this phenomenon?

- If levels of an important cellular molecule drop, allosteric regulation will increase the rate of the enzyme catalyzing the rate-limiting reaction. Conversely, if an excess of the molecule begins to accumulate in the cell, allosteric regulation can slow down the pathway by re-establishing an appropriate rate-limiting reaction.
- Viral & bacterial infection or environmental poisons can interfere with a specific reaction in a metabolic pathway; remedies would depend on this information!
- Some genetic diseases result from mutational enzyme deficiencies; prenatal knowledge could inform the course of a pregnancy while post-natal knowledge might dictate a course of treatment.
- Treatment of a metabolic disease can itself be designed to enhance or inhibit (as appropriate) enzyme activity.

Most enzymes are proteins. But the reaction mechanisms and kinetics of non-protein enzymes (e.g., *ribozymes* and RNA components of *ribosomes*) can be analyzed and classified by the same methods. We'll look more closely at how enzymes are regulated when we discuss glycolysis, the anaerobic pathway that most living things use to extract energy from nutrients. But for now, let's take an overview of enzyme kinetics (for clear, detailed explanations of enzyme catalytic mechanisms, check out Jencks WP [1987, *Catalysis in Chemistry and Enzymology*. Mineola, NY, Courier Dover Publications]).

C. Enzyme Kinetics

Common to all catalyzed chemical reactions, enzyme-catalyzed reactions display *saturation kinetics*, as shown below.

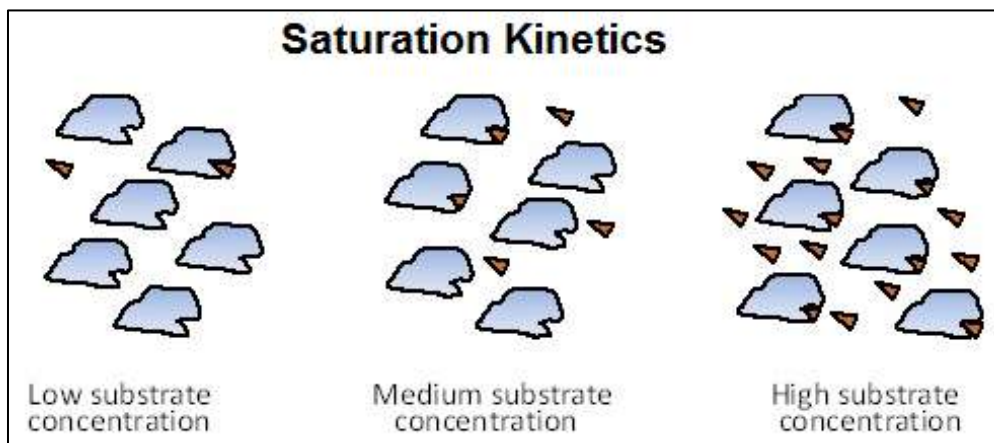

Note how at high substrate concentration the active sites on all the enzyme molecules are bound to substrate molecules.

An experiment to determine the kinetics of enzyme E catalyzing the conversion of S to P is shown below. A series of reaction tubes are set up, each containing the same concentration of enzyme ([E]) but different concentrations of substrate ([S]).

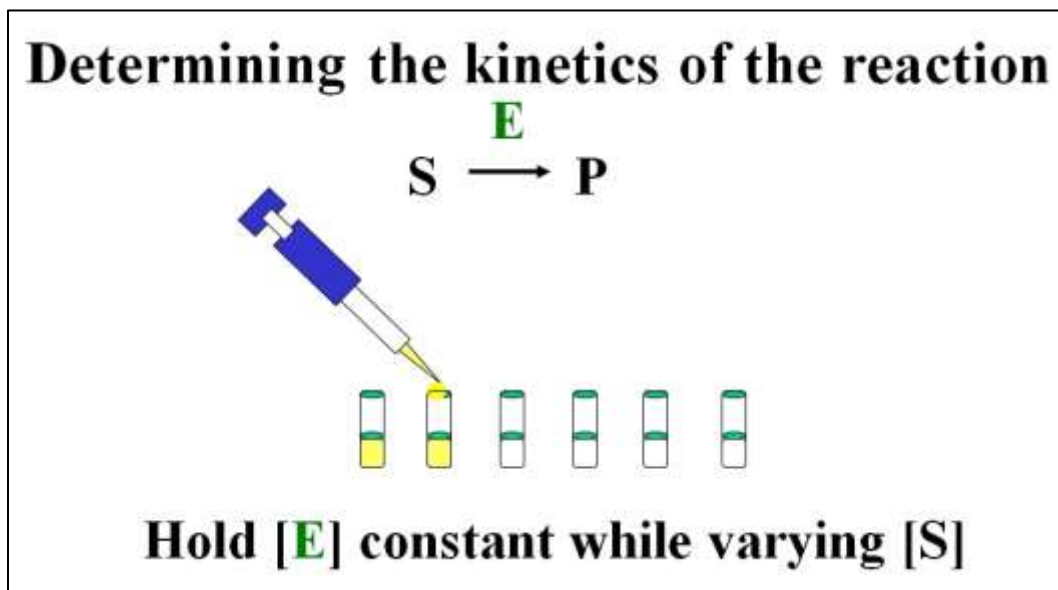

The concentration of P ([P]) produced at different times just after the start of the reaction in each tube is plotted to determine the *initial rate* (v_0) of P formation for each concentration of substrate tested (see below).

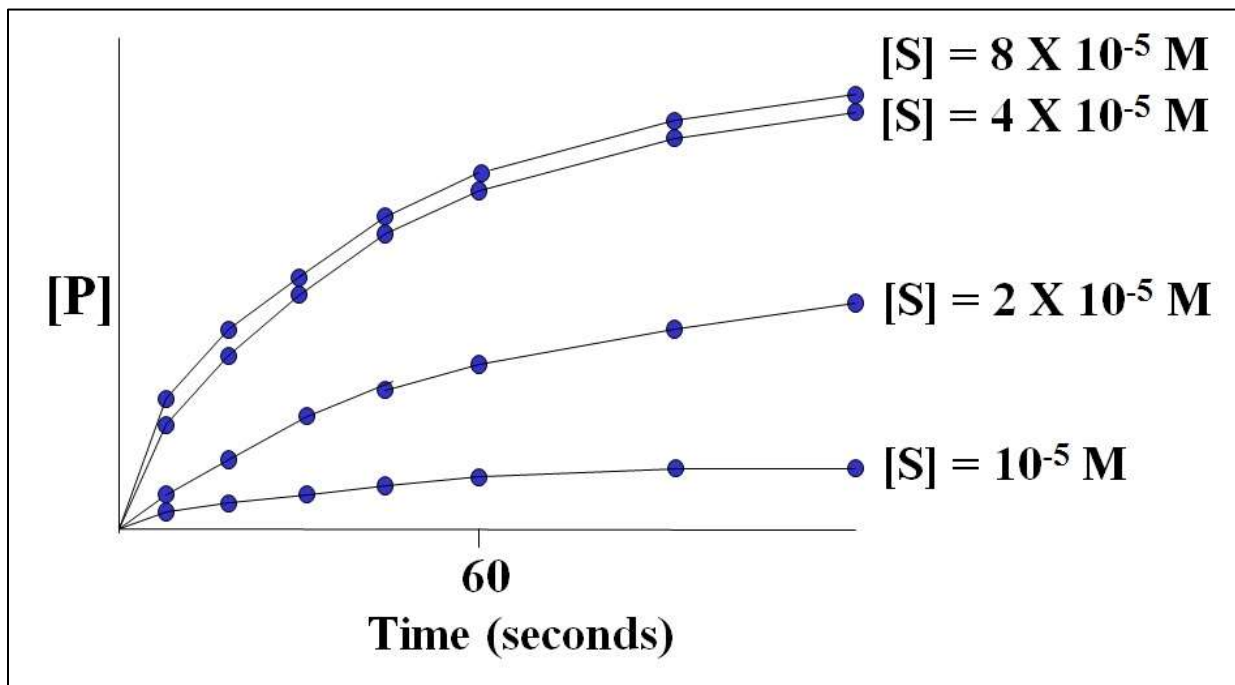

In this hypothetical example, the rates of the reactions (amount of P made over time) do not increase at substrate concentrations higher than $4 \times 10^{-5} \text{ M}$. The upper curves therefore represent the maximal rate of the reaction at the experimental concentration of enzyme. We say that the maximal reaction rate occurs at *saturation*.

CHALLENGE: What's happening in this graph; why do all of the curves level off? Why do all the curves show *saturation*? Answer by imagining what the physical enzyme is doing at each point on the curves.

Next, we can estimate the initial reaction rate (v_0) at each substrate concentration by plotting the slope of the first few time points through the origin of each curve in the graph.

The initial reaction rates estimated in this way are illustrated in the graph below.

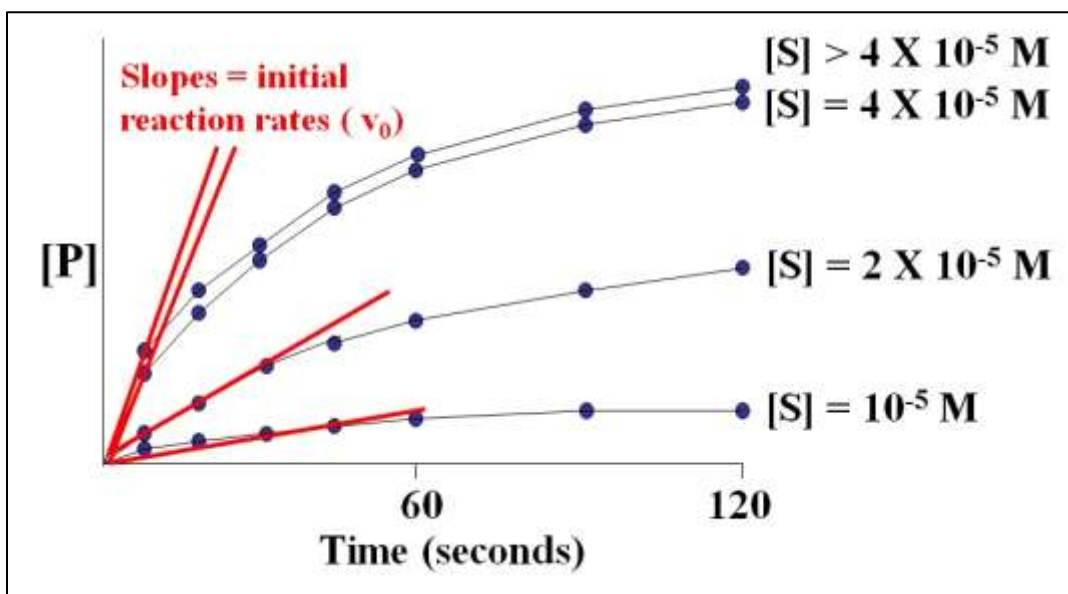

Each straight (red) line is the v_0 for the reaction at a different $[S]$ at the very beginning of the reaction, when $[S]$ is high and $[P]$.

Next, these rates (slopes) can be plotted against the different concentrations of S in the experiment to get the curve below.

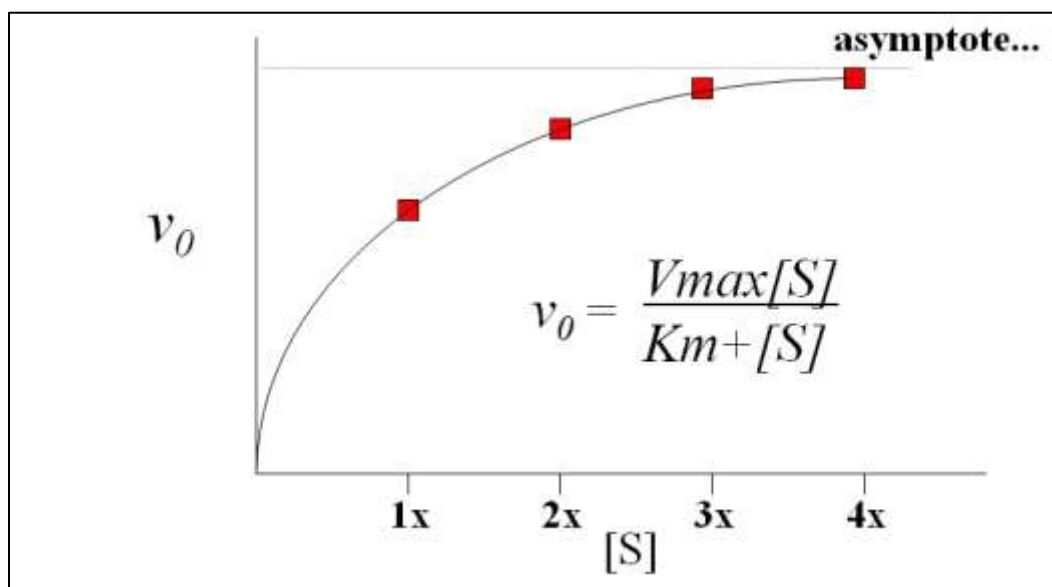

This is an example of Michaelis-Menten kinetics common to many enzymes, named after the two biochemists who realized that the curve described *rectangular hyperbola*. Put another way, the equation mathematically describes the mechanism of catalysis of the enzyme.

A rectangular hyperbola is mathematically described by the following equation:

$$y = \frac{xa}{x+b}$$

You might be asked to derive, or understand the derivation of the Michaelis-Menten equation in a Biochemistry course. Suffice it to say here that Michaelis and Menten started with some simple assumptions about how an enzyme-catalyzed reaction would proceed and wrote reasonable chemical reactions reflecting how a catalyzed reaction would proceed. Here are the equations for a simple reaction in which an enzyme (E) catalyzes the conversion of substrate (S) to product (P):

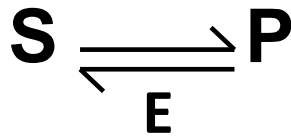

Here are the reasonable chemical rate equations for this reaction that treat the enzyme as a reactant as well as a product of the catalyzed reaction:



Next they wrote the rate equations for each of these chemical reactions, and proceeded to re-write and combine the equations based on expectations of [S], [P], [E], [E-S] and [E-P] at the start of the reaction. Try writing the basic rate equations for these chemical reactions yourself!

Eventually, Michaelis and Menten derived the equation that came to be known by their names:

$$v_0 = \frac{V_{\max}[S]}{K_m + [S]}$$

Save the derivation for another course! Focus instead on the assumptions about what is happening at the very start of an enzymatic reaction. For example, what should the initial concentrations of **E**, **S**, **E-S**, **E-P**, and **P** be (i.e., at the start of the reaction). Such assumptions enabled Michaelis and Menten to simplify, combine and ultimately rewrite the three rate equations above to derive the relationship between v_0 , V_{\max} , $[S]$ and K_m .

In the generic example of substrate conversion to product, increasing $[S]$ results in a higher rate of product formation because the rate of encounters of enzyme and substrate molecules increases. However, at higher and higher $[S]$, v_0 *asymptotically* approaches a theoretical maximum for the reaction, defined as V_{\max} , the *maximum initial rate*. As we've already seen, V_{\max} occurs when all available enzyme active sites are occupied by substrate. At this point, the reaction rate is determined by the intrinsic catalytic rate of the enzyme (sometimes referred to as the *turnover rate*).

The substrate concentration at which the reaction rate has reached $\frac{1}{2}V_{\max}$ is defined as K_M (the *Michaelis-Menten constant*). The K_m is a ratio of rate constants remaining after rewriting the rate equations for the catalyzed reaction.

CHALLENGE: The K_m is equivalent to a *dissociation constant* and the reciprocal of the K_m is often called the K_a , or *affinity constant*. Look carefully at the Michaelis-Menten curve and describe in words why the K_m would be a measure of the tendency of enzyme and substrate to stay together (or conversely, to come apart).

The two most important kinetic properties of an enzyme are:

1. how quickly the enzyme becomes saturated with a particular substrate, which is related to the K_m for the reaction, and
2. the maximum rate of the catalyzed reaction, described by the V_{\max} for the reaction.

Knowing these properties suggests how an enzyme might behave under cellular conditions, and can show how the enzyme will respond to changes in these conditions, including allosteric regulation by inhibitory or activating regulatory factors.

The **Enzyme Kinetics VOPs** (see links above) provide examples of how the kinetics of an enzyme-catalyze reaction would actually be measured and then interpreted. You can also find details of how kinetic equations are derived (a necessary step in understanding how the enzyme works) in any good biochemistry textbook, or check out the *Michaelis-Menten Kinetics* entry in in the [Enzymes](#) Wikipedia link.

Some iText & VOP Key Words and Terms

activation energy	enzyme	Michaelis-Menten constant
active site	enzyme activation	Michaelis-Menten kinetics
allosteric change	enzyme inhibition	rate-limiting reaction
allosteric effector	enzyme kinetics	ribozyme
allosteric site	enzyme regulation	saturation kinetics
biochemical pathway	induced fit	substrate specificity
catalytic RNAs	inorganic catalyst	substrates
conformation	Km	Vmax

Chapter 6: Glycolysis, the Krebs Cycle and the Atkins Diet

*Glycolysis, Gluconeogenesis & the Krebs Cycle - Getting Energy from Food;
Enzyme Regulation & the Bioenergetics of Cellular Free Energy Capture;
Liver Cells in Glucose metabolism; Fooling Your Body - Atkins (& South Beach) Diets*

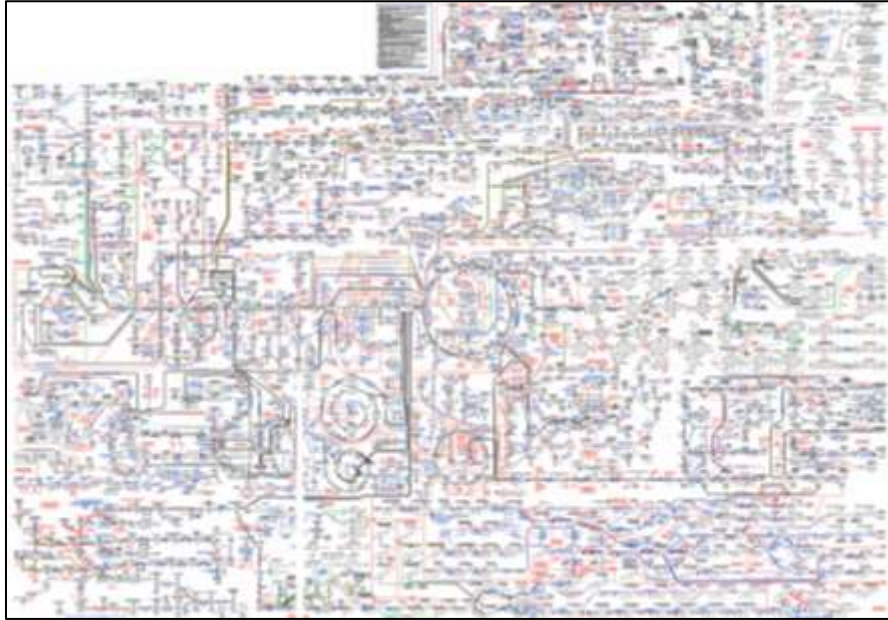

http://mhrussel.files.wordpress.com/2012/12/metabolic_pathways_for_plotter_landscape_quantum

I. Introduction

We've looked at the principles governing energy flow in the universe (thermodynamics) and in living systems (bioenergetics). We saw evidence that energy can be exchanged between components in the universe, but it can be *neither created nor destroyed*. That makes the universe a closed system, a conclusion codified as the first law of thermodynamics.

Personally, I find it a little troubling that there is no escape, until I remind myself that the universe is a pretty big place, and I am only part of a small system. You can define your system for yourself: the solar system, planet earth, the country you pledge allegiance to, your city or village, your school, a farm or homestead...! Then derive some comfort from the realization that you can move from one system to another and even exchange goods and services between them. This is a metaphor for energy flow between systems in the universe.

We also said that the first law applies to *closed* systems within the universe. The truth is that there are no closed systems in the universe. Systems in the universe are open, meaning

that they are always exchanging energy. What we mean by the term ‘closed system’ is that we can define (or isolate) some small part of the universe and *measure* any energy that this isolated system gives up to or takes in from its environment. The simplest demonstration of the first law in action was using a bomb calorimeter to measure heat released or absorbed during a chemical reaction. The second concept we looked at was the one that says that energy flows from one place to another only *when it can*. In the vernacular, we say that energy flows *downhill*. Anything that happens in the universe (a galaxy moving through space, a planet rotating, you getting out of bed, coffee perking, sugar burning in your cells, your DNA dividing) does so because of a downhill flow of energy. We saw that by definition, any happening or event in the universe, however large or small, is *spontaneous* (remember, that doesn’t mean instantaneous!), occurring with a release of *free energy*.

With this brief reminder about energy, we are going to look at how our cells capture the energy in *nutrients*. In this chapter we tackle the first two pathways of *respiration* to see how we humans (and heterotrophs generally) extract the energy that was packed into nutrients during the growth and activities of the plants and critters we eat. We’ll compare both *closed system bioenergetics* for the reactions (particularly in *glycolysis*) and then how we account for chemical reactions and energy transfer in real cells, which are *open systems* that never reach equilibrium.

The complete respiratory pathway can be summarized by the following equation:



The standard free energy change for this reaction (ΔG_o) is about -687Kcal/mole. That is the maximum amount of nutrient free energy that, at least in theory, could be extracted by the complete respiration of a mole of glucose. It takes about 7.3 Kcal to make each mole of ATP (*adenosine triphosphate*). Let’s see what happens in glycolysis.

Voice-Over PowerPoint Presentations

[Glycolysis: Stage 1](#)

[Glycolysis: Stage 2](#)

[Glycolysis & Gluconeogenesis: How the Atkins Diet Works](#)

[Respiration: The Krebs Cycle](#)

Learning Objectives

When you have mastered the information in this chapter and the associated VOPs, you should be able to:

1. Define (explain the difference between) glycolysis and fermentation
2. Calculate and then compare and contrast ΔG_o and $\Delta G'$ for the same reaction, and explain any differences between the change in free energy under the different conditions

3. Describe and explain the major events of the *first* and *second* stages of *glycolysis*
4. State the role of *redox reactions* in glycolysis and fermentation
5. Compare and contrast glucose (carbohydrates in general), ATP, NADH and FADH₂ as *high energy* molecules. [Just for fun, click [Power in the Primordial Soup](#) to read some *far out* speculations on prebiotic high energy molecules that might have been around when ATP was being hired for the job!]
6. Explain why only a few cell types in the human body conduct *gluconeogenesis*, and articulate the purpose of this pathway
7. Explain why the *Atkins Diet* works and speculate on the downside of this and the related South Beach Diet
8. Explain the concept of a *super-catalyst* and why one like the *Krebs Cycle* would have evolved
9. Compare the *phosphate ester linkage* in ATP and GTP and the *thioester linkage* in *acetyl-S-CoA* and *succinyl-S-CoA* in terms of energetics and the reactions they participate in
10. Speculate on why the Krebs Cycle in *E. coli* generates GTP molecules and why it generates ATP molecules eukaryotes.

II. Glycolysis (from the Greek, meaning sugar (*glyco*) separation (*lysis*), or sugar breakdown.

One of the properties of life is that living things require energy. The pathways we look at in this chapter are part of the flow of energy through life (shown below).

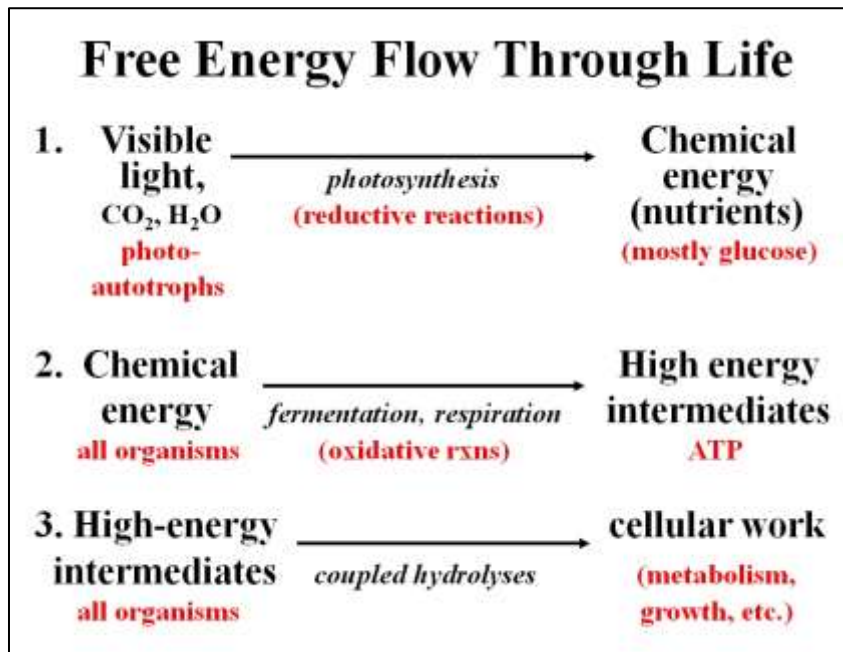

All energy on planet earth comes from the sun, via *photosynthesis*. Recall that light energy fuels the formation of glucose and O₂ from CO₂ and water. In sum, all cells require nutrients, using either *anaerobic* or *aerobic* processes (fermentation or respiration) to capture nutrient free energy. The most common intracellular *energy currency* is ATP. Its high energy content, derived from nutrient free energy, is readily available to fuel almost all cellular activities. As you will see, nutrients serve to provide energy as well as the chemical building blocks of life (amino acids, nucleic acids, vitamins, etc.).

ATP is characterized as a high-energy intermediate, having captured nutrient free energy in a form that cells can use to fuel nearly all cellular work, from building macromolecules to bending cilia to contracting muscles to transmitting neural information. It takes about 7.3 Kcal of free energy to make ATP in a dehydration synthesis reaction linking a phosphate to ADP, forming a phosphate ester 'bond'. The hydrolysis of ATP releases that energy in reactions coupled to cellular work. The energetics of ATP hydrolysis and synthesis are summarized below.

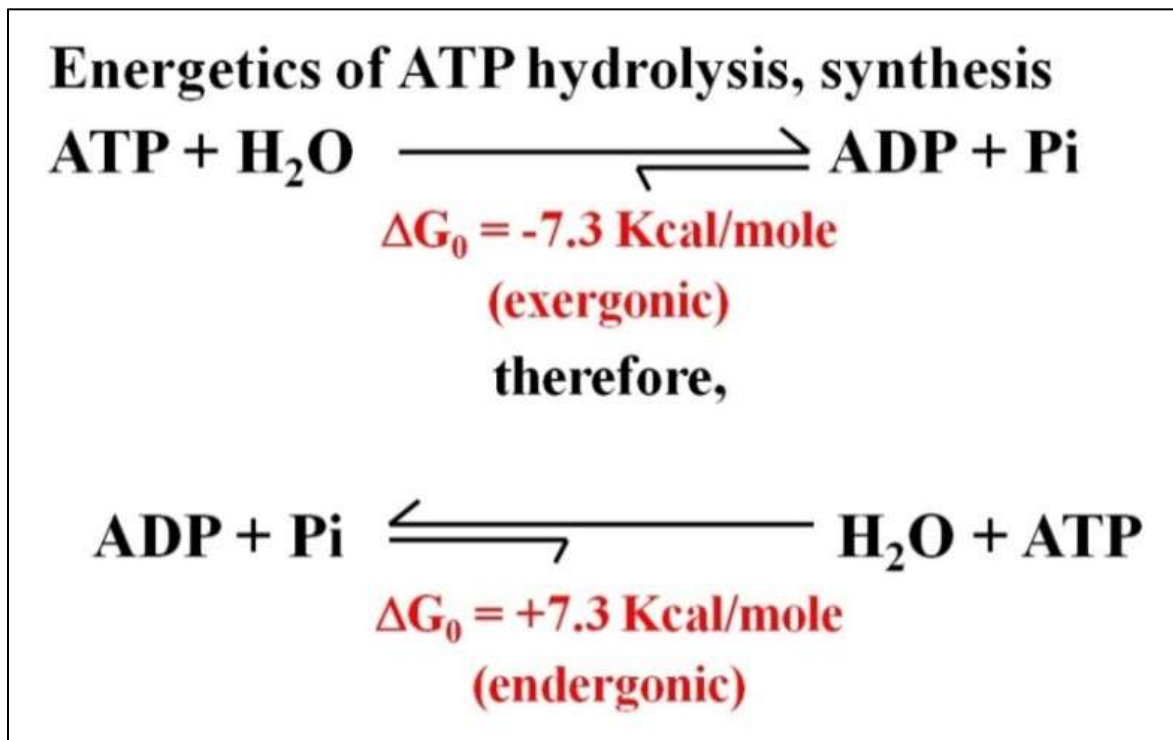

In animals the free energy needed to make ATP in cells comes from nutrients (sugars, fats, proteins). Plants can capture energy from these nutrients but can also get free energy directly from sunlight.

The oxidation of a molecule of glucose releases a considerable amount of free energy, enough to synthesize many molecules of ATP (shown below).

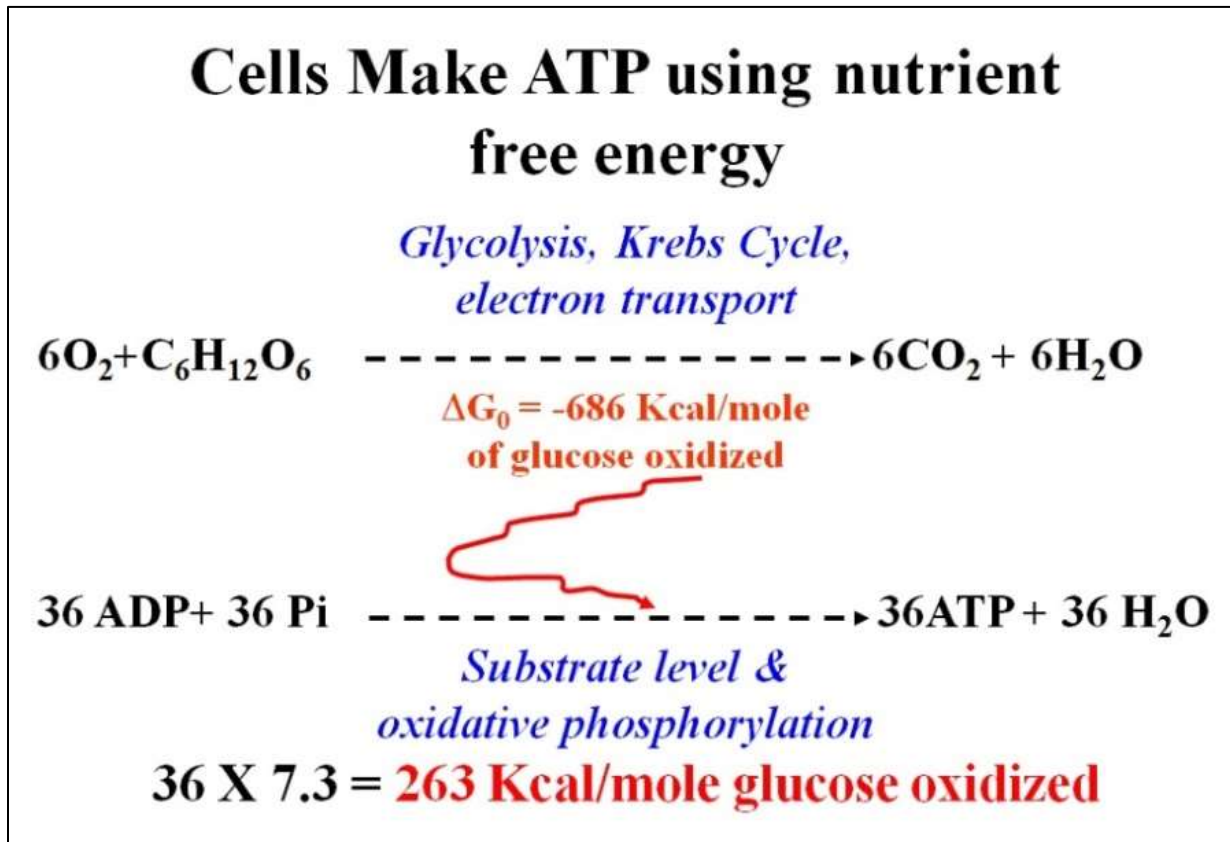

The stepwise oxidation of glucose in cells occurs during respiration, starting with **glycolysis**. The glycolytic pathway we consider to be glycolysis here was originally called the *Embden-Myerhoff Pathway*. Otto Myerhoff shared a Nobel Prize in Physiology or Medicine with Archibald V. Hill in 1922 for isolating the glycolytic enzymes from muscle cells (Embden's contributions came later).

Glycolysis is the first step in capturing nutrient chemical (free) energy, part 2 of the *Free Energy Flow Through Life* (above). Glycolysis is also one of the oldest (most highly conserved) biochemical pathway in evolution, found in all organisms. Check out Fothergill-Gilmore LA [(1986) *The evolution of the glycolytic pathway*. Trends Biochem. Sci. 11:47-51].

The glycolytic pathway occurs in the cytosol of cells where it breaks down each molecule of glucose ($\text{C}_6\text{H}_{12}\text{O}_6$) into two molecules of pyruvic acid (*pyruvate*; CH_3COCOOH). This occurs in two stages, capturing nutrient free energy in two ATP molecules per molecule of glucose that enters the pathway.

The reactions of glycolysis are summarized below, highlighting the two stages of the pathway.

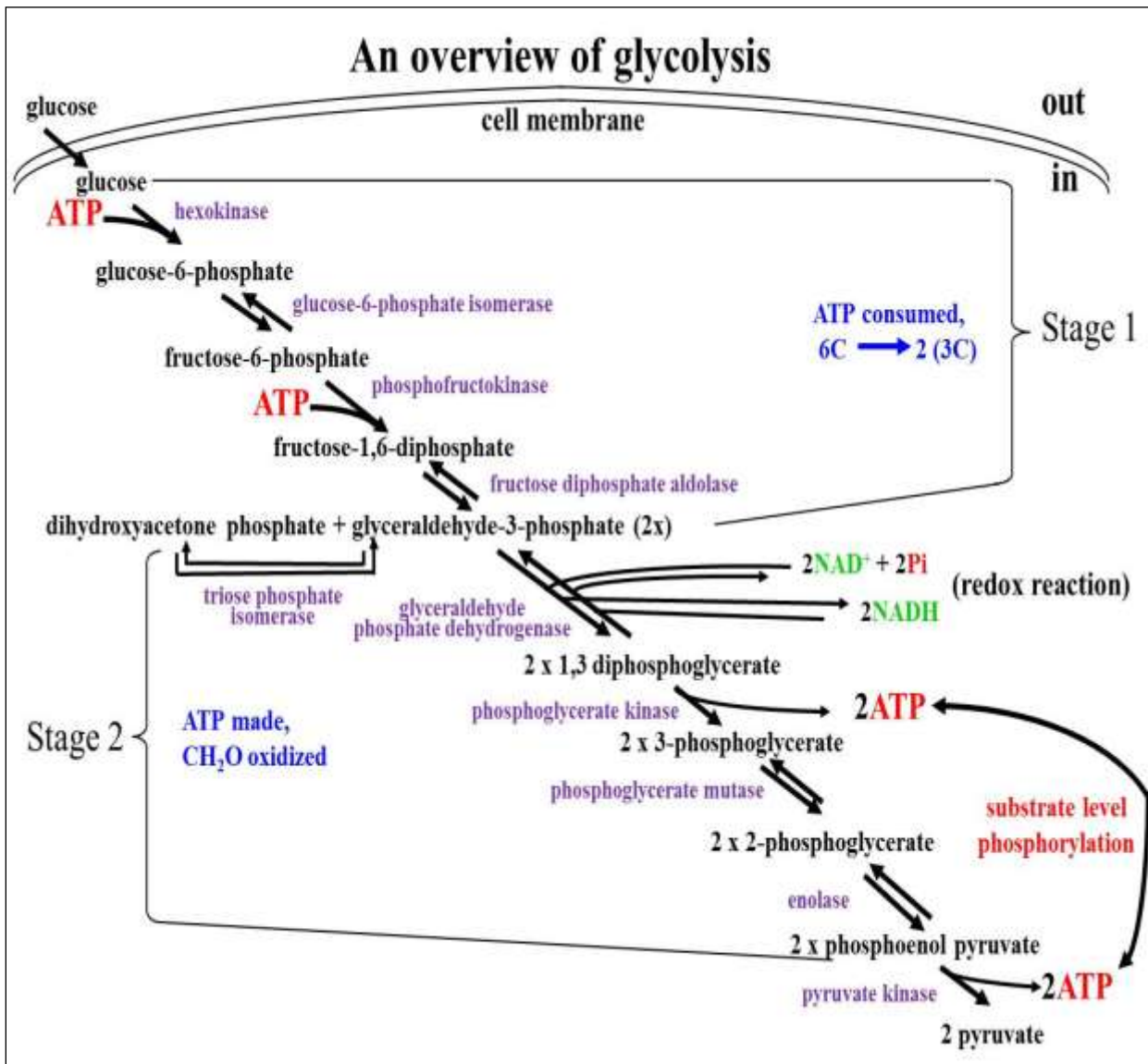

In Stage 1 of glycolysis, phosphates are transferred from ATP first to glucose and then to fructose-6-phosphate, catalyzed by *hexokinase* and *phosphofructokinase* respectively. Free energy is consumed in Stage 1 to fuel these phosphorylations. Next, in Stage 2, nutrient free energy is captured in ATP and NADH (reduced *nicotinamide adenine dinucleotide*). In fact, four molecules of ATP and two of NADH are produced by the time a single starting glucose molecule is split into two molecules of pyruvic acid (pyruvate).

Note that NADH formation is a *redox* reaction; a hydrogen molecule (two protons and two electrons) is removed from glyceraldehyde-3-phosphate and split into a proton and a hydride ion (H^- ; a proton and two electrons). NAD^+ is then reduced by the hydride ion.

Pyruvate is metabolized either anaerobically or aerobically. Anaerobic glycolysis produces a net yield of two ATPs with no consumption of O_2 and no net oxidation of nutrient (i.e., glucose). Respiration is the complete oxidation of glucose to CO_2 and H_2O . The anaerobic and aerobic fates of pyruvate are summarized below.

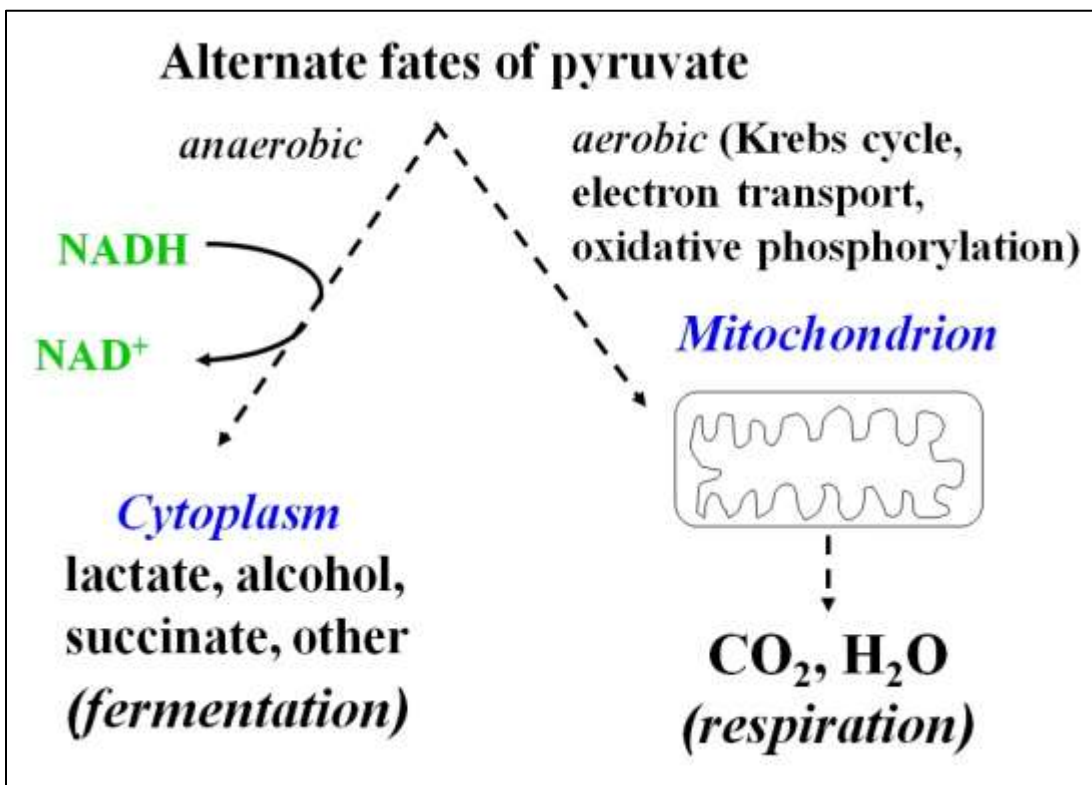

In anaerobic organisms, pyruvate is reduced by electrons in NADH, creating one of several fermentation end-products. The most familiar, made by yeast living without oxygen, is ethanol (alcohol). Also, if you ever experienced *muscle fatigue* after especially vigorous and prolonged exercise, then you (or at least your skeletal muscles) are guilty of fermentation, the anaerobic build-up of lactic acid in muscle cells.

In this and the next chapter we'll focus on the *oxidation* of pyruvate in the Krebs cycle, electron transport and oxidative phosphorylation, the pathways that follow glycolysis in aerobes. We begin with a closer look at glycolysis, focusing on the enzyme catalyzed reactions and watching free energy transfers between pathway components. We will look at the energetics and enzymatic features of each reaction.

A. Glycolysis, Stage 1

Reaction 1: In the first reaction of glycolysis, glucose enters the cell and is rapidly phosphorylated to make glucose-6-phosphate (**G-6-P**). This reaction is catalyzed by the enzyme **hexokinase**. As shown below, the overall reaction is *exergonic*; the *free energy change* for the reaction is -4 Kcal per mole of G-6-P synthesized.

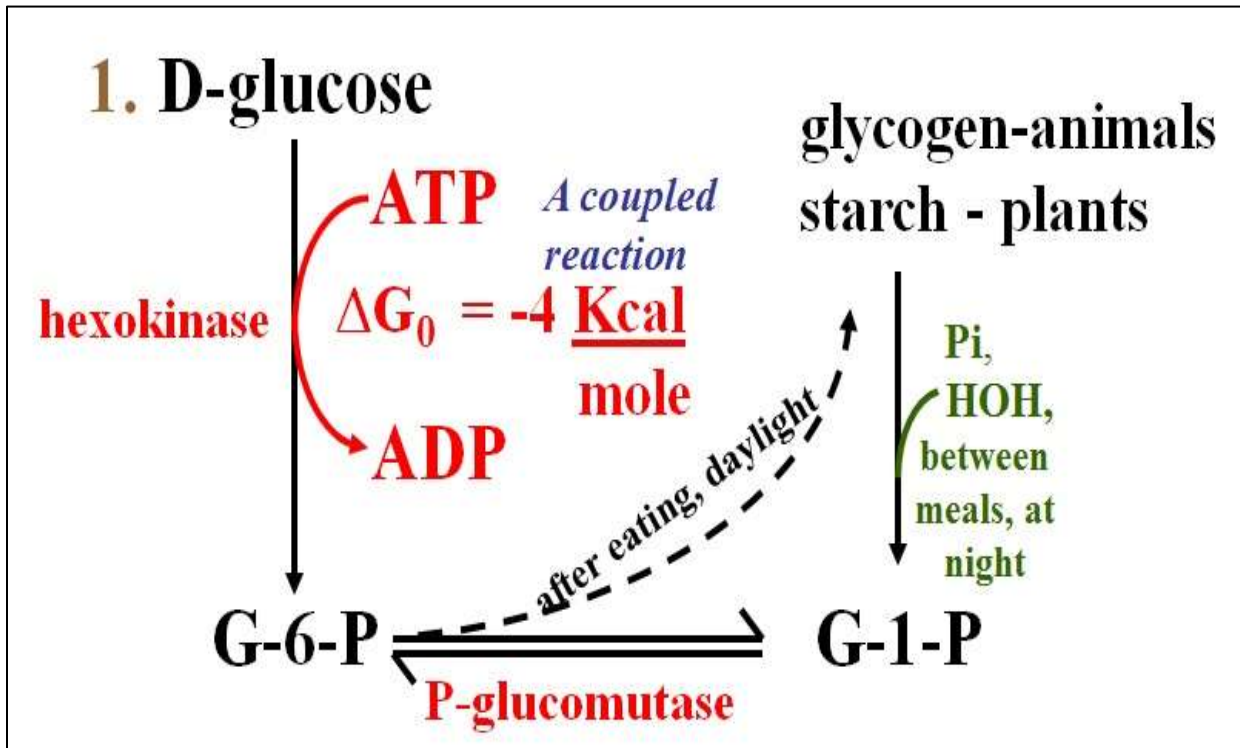

This is a coupled reaction, meaning that the phosphorylation of glucose is coupled to the hydrolysis of ATP. In energy terms, the free energy of ATP hydrolysis (energetically favorable) is used to fuel the phosphorylation of glucose (energetically *unfavorable*). The reaction is also **biologically irreversible**, as shown by the single vertical arrow above.

Excess dietary glucose is stored in most cells, but especially liver and kidney cells, as glycogen, a highly branched polymer of glucose monomers. Glucose made by photosynthesis in green algae and plants stored as starch. In animals glycogen is hydrolyzed back to glucose in the form of glucose-1-phosphate (**G-1-P**) which is converted to G-6-P.

Let's take a look at the energetics (free energy flow) for the coupled hexokinase-catalyzed reaction. This reaction is actually the sum of the two coupled reactions, as shown below.

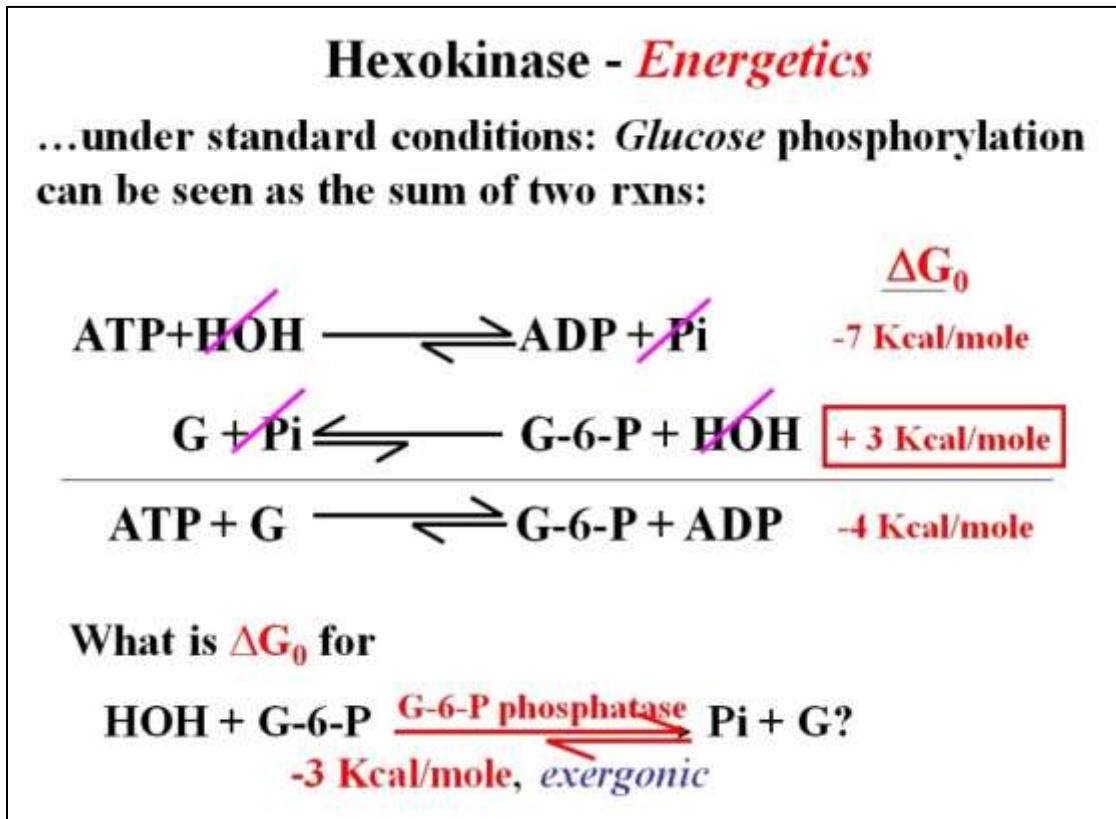

As you can see, ~7 Kcal/mole (rounding down!) are released by ATP hydrolysis in a closed system under standard conditions, an exergonic reaction. On the other hand, the dehydration synthesis reaction of glucose phosphorylation occurs with a ΔG_0 of +3 Kcal/mole. This is an endergonic reaction under standard conditions. Summing up the free energy changes of the two reactions, we get the overall ΔG_0 of -4 Kcal/mole for the coupled reaction under standard conditions in a closed system.

Recall that all chemical reactions are inherently reversible (see *Enzyme Catalysis and Kinetics*). But we noted that the overall coupled reaction is *biologically irreversible*. We say an enzyme catalyzed reaction is biologically irreversible when the products have a relatively low affinity for the enzyme active site, making catalysis of the reverse reaction very inefficient. As you will see, biologically irreversible reactions, including the phosphorylation of glucose catalyzed by hexokinase, are often regulated. Hexokinase is allosterically regulated by G-6-P.

Rising concentrations of G-6-P inside the cell indicates that the cell is not consuming it, implying that its energy needs are being met (see below).

Hexokinase - Enzymatics:

- ***Biologically irreversible: enzyme can't readily catalyze reverse reaction.***
Value to the organism? **once in cell, G can't leave – G transporter doesn't recognize G-6-P**
- ***Allosteric regulation by G-6-P (inhibition)***
Value to the organism? **cells keep what they need, share what they don't**

The mechanism of hexokinase regulation is that “extra” (or excess) G-6-P can bind to an allosteric site on the enzyme. The conformational change in hexokinase is transferred to the active site, inhibiting the reaction.

CHALLENGE: The regulation of hexokinase must have been selected in evolution. Speculate on the benefit of this trait.

Reaction 2: In this reaction, glucose is isomerized, so that G-6-P is converted to fructose-6-P (**F-6-P**). The reaction is catalyzed by an *isomerase* and is slightly *endergonic* (see below).

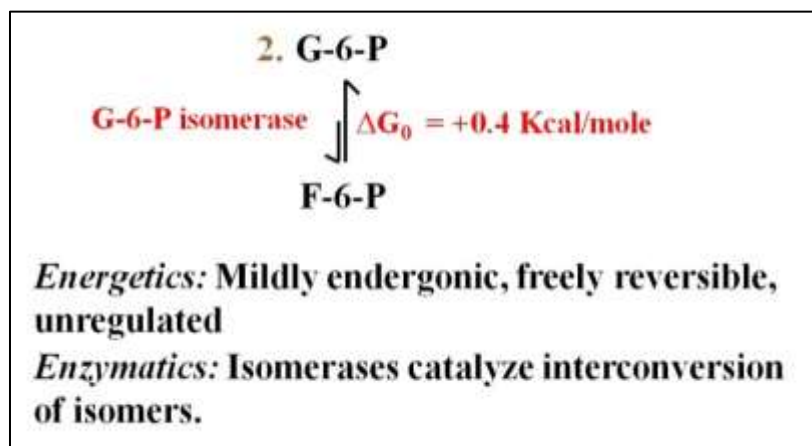

Reaction 3: In this reaction, the enzyme *6-phosphofruktokinase* catalyzes the phosphorylation of F-6-P to make fructose 1, 6 di-phosphate (**F1,6 diP**). This is also a coupled reaction, with ATP providing this second phosphate. The overall reaction and the separation of the two coupled reactions are shown below.

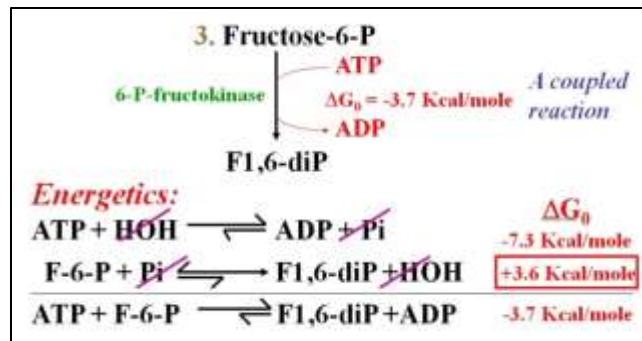

As for the hexokinase reaction, the 6-P-fructokinase reaction is exergonic and biologically irreversible. *Phosphofruktokinase* is also allosterically regulated, in this case by several different allosteric effectors, including ATP, ADP and AMP and long-chain fatty acids.

CHALLENGE: See if you can explain the logic of how these allosteric effectors regulate this reaction.

Reactions 4 and 5: These are the last reactions of the first stage of glycolysis. In one reaction, F1,6 diP (6-carbon sugar) is reversibly split into *dihydroxyacetone phosphate* (**DHAP**) and *glyceraldehyde-3-phosphate* (**G-3-P**). In the second reaction (also reversible) the DHAP is converted into G-3-P. Here are the reactions:

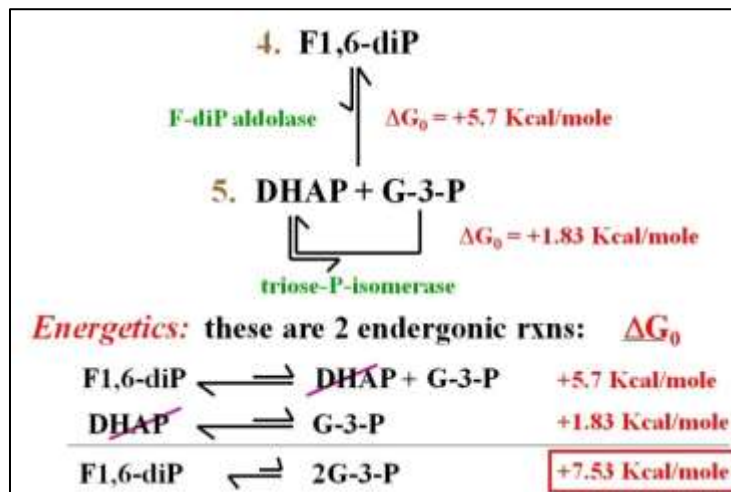

The net result is the formation of 2 molecules of G-3-P. The enzymes *F-diP aldolase* and *triose-P-isomerase* both catalyze freely reversible reactions. Also, both reactions proceed with a positive free energy change and are therefore *endergonic*. The sum of the free energy changes for the splitting of F1,6 diP into two G-3-Ps is a whopping +7.5 Kcal per mole, a very energetically unfavorable process.

CHALLENGE: Given that these reactions are both endergonic, how is it possible that glycolysis ever gets past the synthesis of F1,6 diP?

Summing up, by the end of stage 1 of glycolysis, we have consumed 2 ATP molecules, and split one 6C carbohydrate into two 3C carbohydrates. We have also seen two biologically irreversible and allosterically regulated enzymes.

B. Glycolysis, Stage 2

Stage 1 of glycolysis ends with the splitting of a 6-carbon sugar (glucose) into two 3-carbon carbohydrates (G-3-P). We'll follow just one of these G-3-P molecules, but remember that both are proceeding through Stage 2 of glycolysis.

Reaction 6: This is the redox reaction we promised earlier, in which G-3-P is oxidized and NAD^+ is reduced. As shown below, the enzyme *glyceraldehyde-3-phosphatase dehydrogenase* also catalyzes the phosphorylation of a *phosphoglyceric acid* intermediate to make *1,3, diphosphoglyceric acid (1,3, diPG)*.

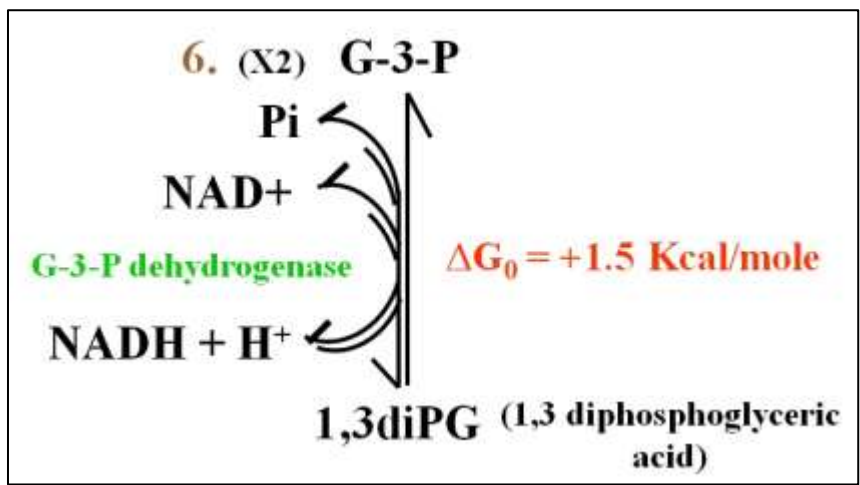

In this *freely reversible endergonic* reaction, a hydrogen molecule (H_2) is removed from G-3-P in the form of a hydride ion (H^-) and a proton (H^+). NAD^+ is reduced by the H^- ion, leaving behind the protons in solution.

G-3-P dehydrogenase is regulated by levels of one of its substrates, NAD^+ . Regulation is by a form of allosteric regulation called **negative cooperativity**: the higher the $[\text{NAD}^+]$, the lower the affinity of the enzyme for more NAD^+ and the faster the reaction in the cell!

CHALLENGE: Explain the logic of this mode of regulation of 1,3 diPG formation.

Reaction 7: The reaction shown below, catalyzed by the enzyme *phosphoglycerate kinase*, is freely reversible and *exergonic*, yielding ATP and 3-phosphoglyceric acid (3PG).

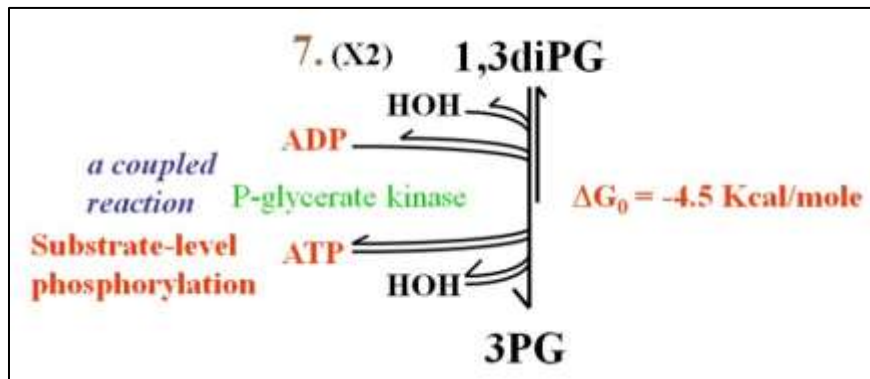

Kinases are enzymes that transfer phosphate groups between molecules, most often to ADP to make ATP by what is called **substrate-level phosphorylation**. In this *coupled reaction* the free energy released by hydrolyzing a phosphate from 1,3 diPG is used to make ATP. Remember that this reaction occurs twice per starting glucose, so that at this point in glycolysis, two ATPs have been synthesized.

Reaction 8: This freely reversible endergonic reaction moves the phosphate from the number 3 carbon of 3PG to the number 2 carbon as shown below.

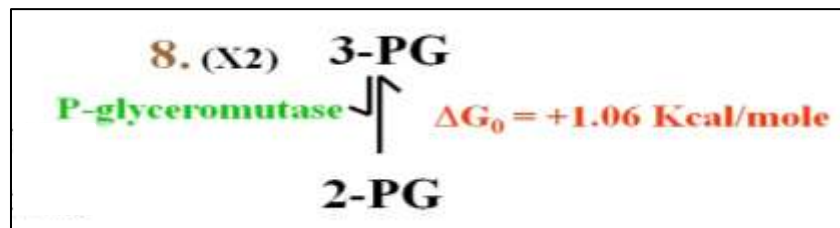

Mutases like phosphoglycerate mutase are enzymes that catalyze the transfer of functional groups within a molecule.

Reaction 9: In this reaction (shown below), the enzyme *enolase* converts 2PG to phosphoenol pyruvate (PEP).

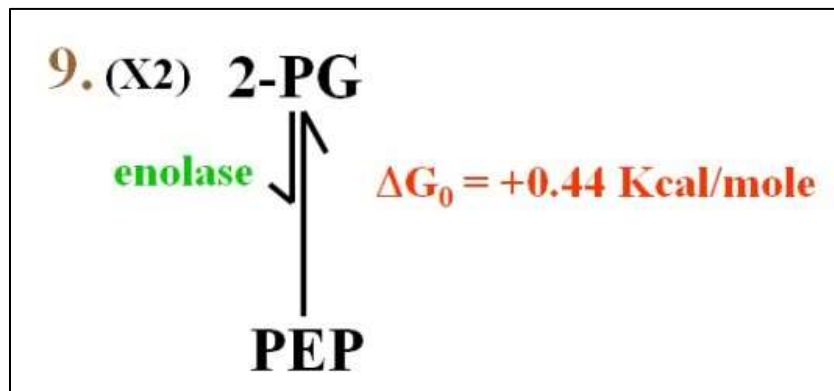

The reaction product, PEP, is another very high energy phosphate compound.

CHALLENGE: 1,3 diPG and PEP are considered a “very high energy” phosphate compounds, compared to ATP, which is called a “high energy phosphate” compound. Explain the difference, and define the term *coupled reaction*.

Reaction 10: This last reaction in *aerobic* glycolysis results in the formation of *pyruvic acid*, or **pyruvate** (again, 2 per starting glucose molecule), shown below.

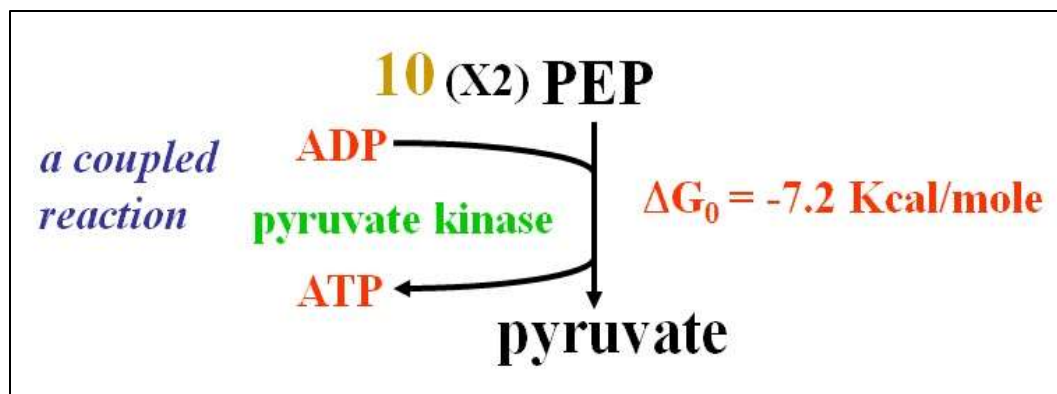

The enzyme *pyruvate kinase* couples the *biologically irreversible*, exergonic hydrolysis of a phosphate from PEP and transfer of the phosphate to ADP in a *coupled reaction*.

Aerobic glycolysis is sometimes called *incomplete glycolysis*. If pyruvate is reduced in subsequent reactions the pathway becomes *complete glycolysis*, also called a **fermentation** (see the *Alternate Fates of Pyruvate*, above). Pyruvate kinase is allosterically regulated by ATP, citric acid, long-chain fatty acids, F1,6 diP, and one of its own substrates, PEP.

CHALLENGE: See if you can predict and explain how each of these allosteric effectors changes the rate of pyruvate kinase catalysis.

Here is a balance sheet for both *complete* and *incomplete* glycolysis, showing chemical products and energy transfers.

Balance sheet of glycolysis

• **Complete: 2 ATP + 2 lactate (no net oxidation)**

$$\Delta G_0 = -50 \text{ Kcal/mole glucose}$$

• **Incomplete: 2 ATP + 2 pyruvate + 2 NADH + 2 H⁺**

$$\Delta G_0 = -44 \text{ Kcal/mole glucose}$$

• **Efficiency of ATP production = 14.6/50 vs 14.6/44**
= 29% vs 33%

CHALLENGE: Where is the free energy that was in glucose?

There are 2 reactions in Stage 2 of glycolysis that each yields a molecule of ATP. Since each of these reactions occurs twice per starting glucose molecule, the 2nd stage of glycolysis produces 4 ATP molecules. Since 2 ATPs were consumed in stage 1, the net yield of chemical energy as ATP by the end of glycolysis down to pyruvate is 2 ATPs. That's just about 15 Kcal conserved as the chemical energy of

ATP... out of 687 Kcal potentially available from the mole of glucose! As you will see, there is a lot more free energy available from glucose, much of which remains to be captured during the rest of respiration.

On the other hand, anaerobes which can't make use of oxygen, usually have to settle for the paltry 15 Kcal they get in the net yield of 2 moles of ATP per starting mole of glucose.

Remember that one of the reactions in the 2nd stage of glycolysis is actually a chemical oxidation. But check out fermentation pathways: you will find that there is *no net oxidation of glucose* (i.e., glycolytic intermediates) by the end of a fermentative pathway.

By this time, you will have realized that glycolysis is an energetically favorable (downhill) reaction in a closed system, with an overall negative ΔG_o . In most of our cells glycolysis is normally spontaneous, driven by a constant need for energy to do cellular work. Thus the actual free energy of glycolysis, or $\Delta G'$, is also negative.

So next we'll look at gluconeogenesis, the Atkins Diet and some not-so-normal circumstances when glycolysis essentially goes in reverse, at least in a few cell types. Under these conditions, glycolysis is energetically unfavorable, and those reverse reactions are the ones proceeding with a negative $\Delta G'$!

III. Gluconeogenesis

In a well-fed animal, most cells can store a small amount of glucose as glycogen. All cells break glycogen down as needed to retrieve nutrient energy as G-6-P. Glycogen hydrolysis is called *glycogenolysis*. For most cells, glycogen is quickly used up between meals. Therefore these cells depend on an external source of glucose other than diet. Those sources are liver and to a lesser extent, kidney cells, which can store large amounts of glycogen after meals. In continual feeders (for examples cows and other ruminants), glycogenolysis is ongoing. In *intermittent feeders* (like us) liver glycogenolysis can supply glucose to the blood for distribution to all cells of the body for 6-8 hours between meals, depending on the level of activity. So, after a good night's sleep, a period of intense exercise, a day or any prolonged period of low carbohydrate intake (fasting or starvation), even liver and kidney glycogen reserves will be mobilized and even depleted. Under these circumstances, animals use **gluconeogenesis** (literally, *new glucose synthesis*) in liver and kidney cells to provide systemic glucose to nourish other cells. As always in otherwise healthy individuals, the hormones insulin and glucagon regulate blood *glucose homeostasis*, protecting against *hypoglycemia* (low blood sugar) and *hyperglycemia* (high blood sugar) respectively.

Gluconeogenesis is a metabolic pathway that produces glucose from non-carbohydrate carbon substrates. In humans these substrates include pyruvate, lactate, glycerol and *gluconeogenic amino acids* (those that can be converted to alanine). Except for so-called *bypass reactions*, gluconeogenesis is essentially a reversal of glycolysis. The bypass reactions are necessary to get around the three biologically irreversible reactions of glycolysis.

The pathways of glycolysis and gluconeogenesis are illustrated side by side (below) to highlight both the bypass reactions and those of glycolysis that function in gluconeogenesis.

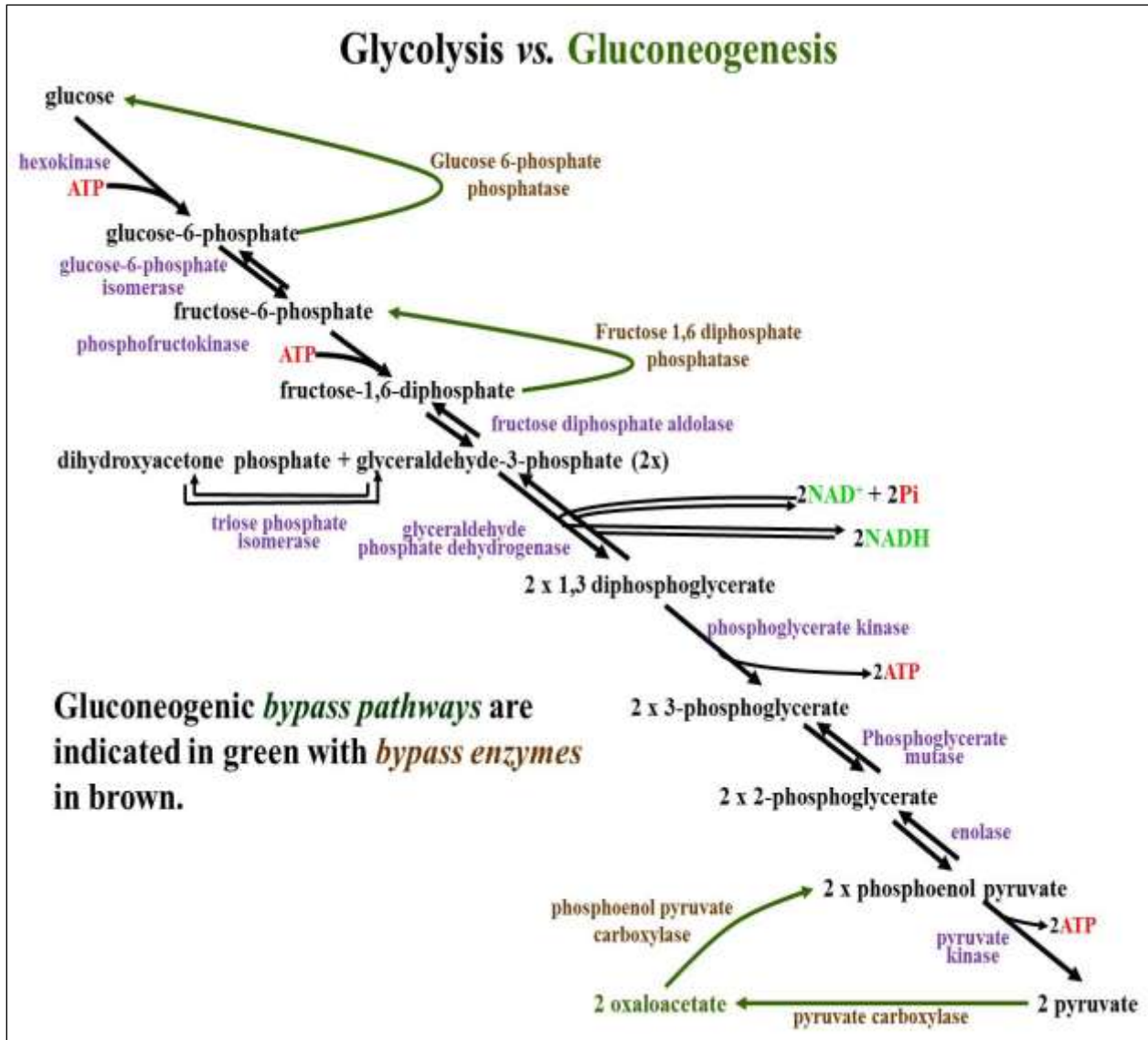

If glycolysis is an exergonic pathway, then gluconeogenesis must be an endergonic one. Gluconeogenesis is only possible if the bypass enzymes are present. Not shown in the pathway is the fact that gluconeogenesis consumes 4 ATP and 2 GTP molecules. But in spite of this free energy requirement, gluconeogenesis is energetically favorable! This is because the cell is an open system. An accumulation of pyruvate and the rapid release of new glucose from the cells into the blood drive the reactions toward glucose synthesis. And pyruvate will build up if the liver (or kidney) cells experience a buildup of *gluconeogenic amino acids*.

As implied in the foregoing discussion, glycolysis and gluconeogenesis are not simultaneous! As in all cell types, glycolysis is the normal pathway. Gluconeogenesis in liver (and kidneys) is regulated by glucocorticoid hormones that signal the cells to synthesize the *bypass reaction enzymes* (the two *carboxylases* and *phosphatases* indicated in brown in the illustration). The same glucocorticoid hormones also stimulate other cell types to break down fats and proteins (below).

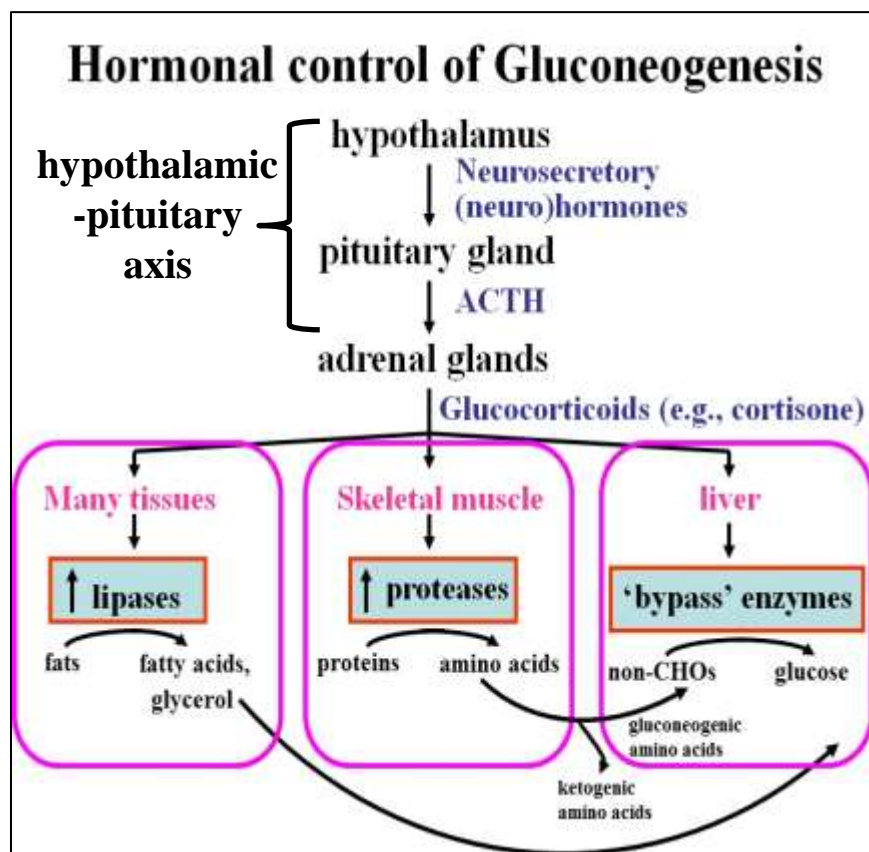

Levels of lipases that catalyze fat hydrolysis increase in response to glucocorticoids, generating *fatty acids* and *glycerol*. Most cells can use fatty acids as an alternate energy

nutrient when glucose is limiting. Liver cells then take up glycerol and converted it to G-3-P, contributing to gluconeogenesis. Glucocorticoid hormones stimulate the synthesis of *proteolytic enzymes* in skeletal muscle that catalyze protein breakdown to amino acids that enter the circulation. *Gluconeogenic amino acids* reaching the liver and kidneys are converted to pyruvate, also contributing to gluconeogenesis.

A long night's sleep, fasting and more extremely, starvation are forms of stress. Our stress response begins in the *hypothalamic-pituitary axis*. A consequence is that the *hypothalamus* secretes a neurohormone that stimulates the release of *ACTH (adrenocorticotropic hormone)* from the *pituitary gland*. ACTH then stimulates the release of cortisone and similar glucocorticoids from the cortex (outer layer) of the adrenal glands. As the name glucocorticoid suggests, these hormones participate in the regulation of glucose metabolism. At times when carbohydrate intake is low, the organism reacts by mobilizing alternative energy sources and by making carbohydrates (i.e., glucose) from non-carbohydrate sources. Here are the details:

- Glucocorticoids stimulate gluconeogenic bypass enzyme synthesis in liver cells.
- Glucocorticoids stimulate skeletal muscle *protease* synthesis in skeletal muscle causing hydrolysis of the peptide bonds between amino acids. Gluconeogenic amino acids circulate to the liver where they are the most abundant substrate for gluconeogenesis. *Ketogenic* amino acids resulting from proteolysis are not used in gluconeogenesis. When they are used as substrates for *ketogenesis* during prolonged fasting, *ketosis* may occur, characterized by pungent “acetone” breath in undernourished or starving patients.
- The heart and brain require glucose for energy, and cannot use fats as an alternative. Thus, the essential role of gluconeogenesis is to supply glucose to these organs in the absence of adequate carbohydrate in the diet, including during fasting or starvation. Glucocorticoids induced lipases catalyze hydrolysis of the ester linkages between *fatty acids* and *glycerol* in fats (*triglycerides*) in most cells, including adipose tissue, a major storehouse of fats. As we noted, fatty acids are an alternate energy source to carbohydrates for most cells, and glycerol will circulate to the liver where it is converted to G-3-P to serve *not* as a glycolytic intermediate, but as a gluconeogenic substrate!

It's a pity that we humans cannot use fatty acids as gluconeogenic substrates! Plants and some lower animals have a *glyoxalate cycle* pathway that can convert the product of fatty acid oxidation (acetate) directly into carbohydrates that can enter the gluconeogenic pathway. But we and higher animals in general lack this pathway. Thus, we cannot convert fats to carbohydrates, in spite of the fact that we can all too easily convert the latter to the former!

IV. The Atkins Diet and Gluconeogenesis

You may know that The *Atkins Diet* (also the South Beach diet) is an ultra-low carb diet. On this diet a person is in a pretty much constant gluconeogenic state. While the liver can produce enough glucose for brain and heart cells, the rest of the cells in our bodies will switch to burning fats, hence the weight loss. Discredited a few years back, the Atkins Diet and similar ones like the South Beach diet are now back in favor. On a low glucose (low carb) diet like the Atkins diet, glucocorticoids are released, tricking the body into a gluconeogenic state. While heart and brain get their glucose, other cells switch to fats as an alternate source of energy by turning on the synthesis of required enzymes. Hence the weight loss...

Type 2 (adult-onset) diabetics can control their disease with a low carb diet and a drug called *metformin*, which blocks gluconeogenesis and therefore prevents glucose synthesis from gluconeogenic substrates, at the same time stimulating cellular receptors to take up available glucose. For more details on the mechanism of *metformin* action, check out Hundal RS et al. [(2000) *Mechanism by Which Metformin Reduces Glucose Production in Type 2 Diabetes* Diabetes 49 (12): 2063–9]. Given the prevalence of obesity, and type 2 diabetes in the U.S., someone you know may be taking *metformin*!

V. The Krebs/TCA/Citric acid cycle

Glycolysis through fermentative reactions produces ATP anaerobically. Respiration (the aerobic use of oxygen to efficiently burn nutrient fuels) had to wait until photosynthesis created the oxygenic atmosphere we live in now. Read more about the source of our oxygenic atmosphere in Dismukes GC et al. [(2001) *The origin of atmospheric oxygen on earth: the innovation of oxygenic photosynthesis*. Proc. Nat. Acad. Sci. USA 98:2170-2175].

Evolution of the Krebs cycle, electron transport and oxidative phosphorylation and their chemical bridge to glycolysis no doubt occurred a few reactions at a time, perhaps at first as a means of protecting anaerobic cells from the 'poisonous' effects of oxygen. Later, evolution fleshed out the aerobic pathways we see today. Whatever its initial utility, these reactions were a selective response to the increase in oxygen in the earth's atmosphere. As a pathway for getting energy out of nutrients, respiration is much more efficient than glycolysis. Animals rely on it, but even plants and photosynthetic algae use the respiratory pathway when sunlight is not available!

Here we focus on oxidative reactions in the mitochondria, beginning with pyruvate oxidation and continuing to the redox reaction of the Krebs cycle.

After entering the mitochondria, pyruvate is oxidized to *Acetyl-S-Coenzyme A* (Ac-S-CoA), which will then enter the Krebs cycle to be completely oxidized. Hans Krebs and Fritz Lipmann shared the 1953 Nobel Prize in Physiology or Medicine for their discoveries of the TCA cycle and the reactions that oxidize pyruvate and synthesize Ac-S-CoA. Read Krebs' review of his own research in: Krebs HA [(1970) *The history of the tricarboxylic acid cycle*. *Perspect. Biol. Med.* 14:154-170].

The products of complete oxidation of each pyruvate molecule are 3CO_2 and a lot of reduced electron carriers (NADH, FADH_2). The free energy released in these redox reactions is coupled to the synthesis of only one ATP per pyruvate oxidized. But the NADH, FADH_2 molecules have captured most of the free energy in the original glucose molecules. These reactions are summarized below.

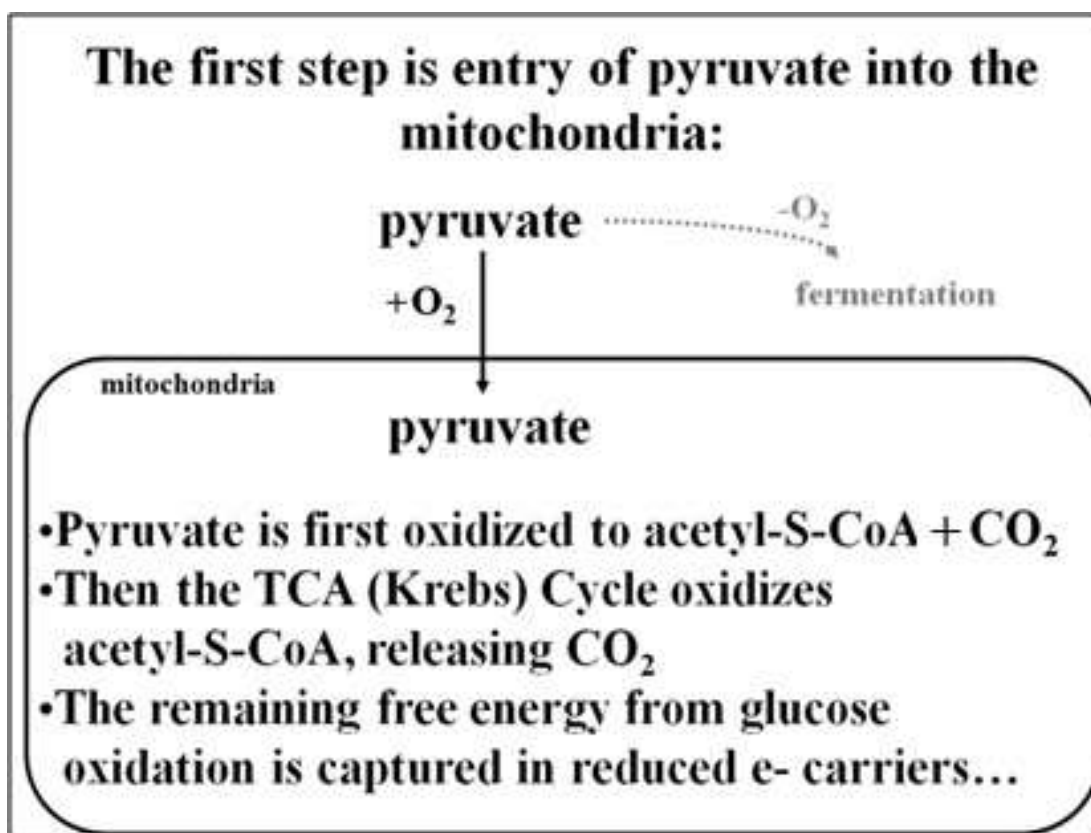

The enzyme *pyruvate dehydrogenase* catalyzes the oxidation of pyruvate, converting a 3-carbon carbohydrate into acetate, a 2-carbon molecule, acetate, releasing a molecule of CO₂. In this highly exergonic reaction CoA-SH forms a *high energy thioester linkage* with the acetate in Ac-S-CoA:

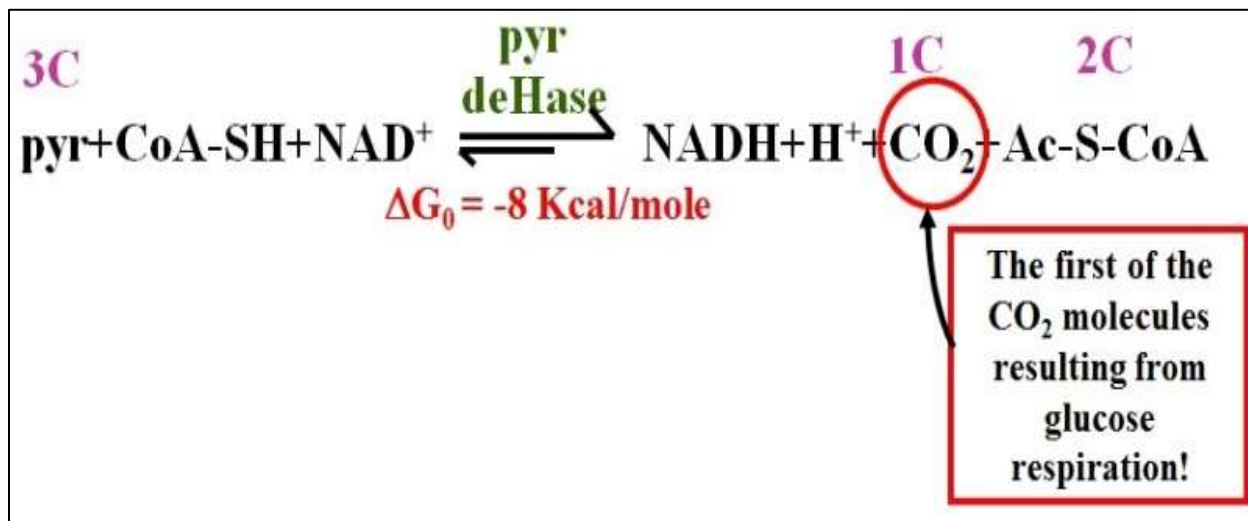

The **Krebs cycle** is a *cyclic* pathway whose key functions are to oxidize Ac-S-CoA, reduce NAD⁺ to NADH, and provide intermediates that can be converted into some amino acids. The Krebs Cycle we see in humans today is shared by all aerobic organisms, consistent with its spread early in the evolution of our oxygen environment. Because of the role of Krebs Cycle intermediates in other biochemical pathways, parts of the pathway may have pre-dated the complete respiratory pathway.

The Krebs Cycle takes place in mitochondria of eukaryotic cells. It is also called the *citric acid cycle* and *the tricarboxylic acid cycle* because its first reaction product, *citric acid*, contains 3 *carboxyl groups*!

CHALLENGE: Where does the Krebs Cycle occur in bacteria?

The Krebs Cycle is a series of reactions of which four are redox reactions. As we discuss the cycle, look for the accumulation of reduced electron carriers (FADH₂, NADH) and a small amount of ATP synthesis by substrate-level phosphorylation. Also, follow the carbons in pyruvate into CO₂.

The Krebs Cycle as it occurs in animals is summarized below.

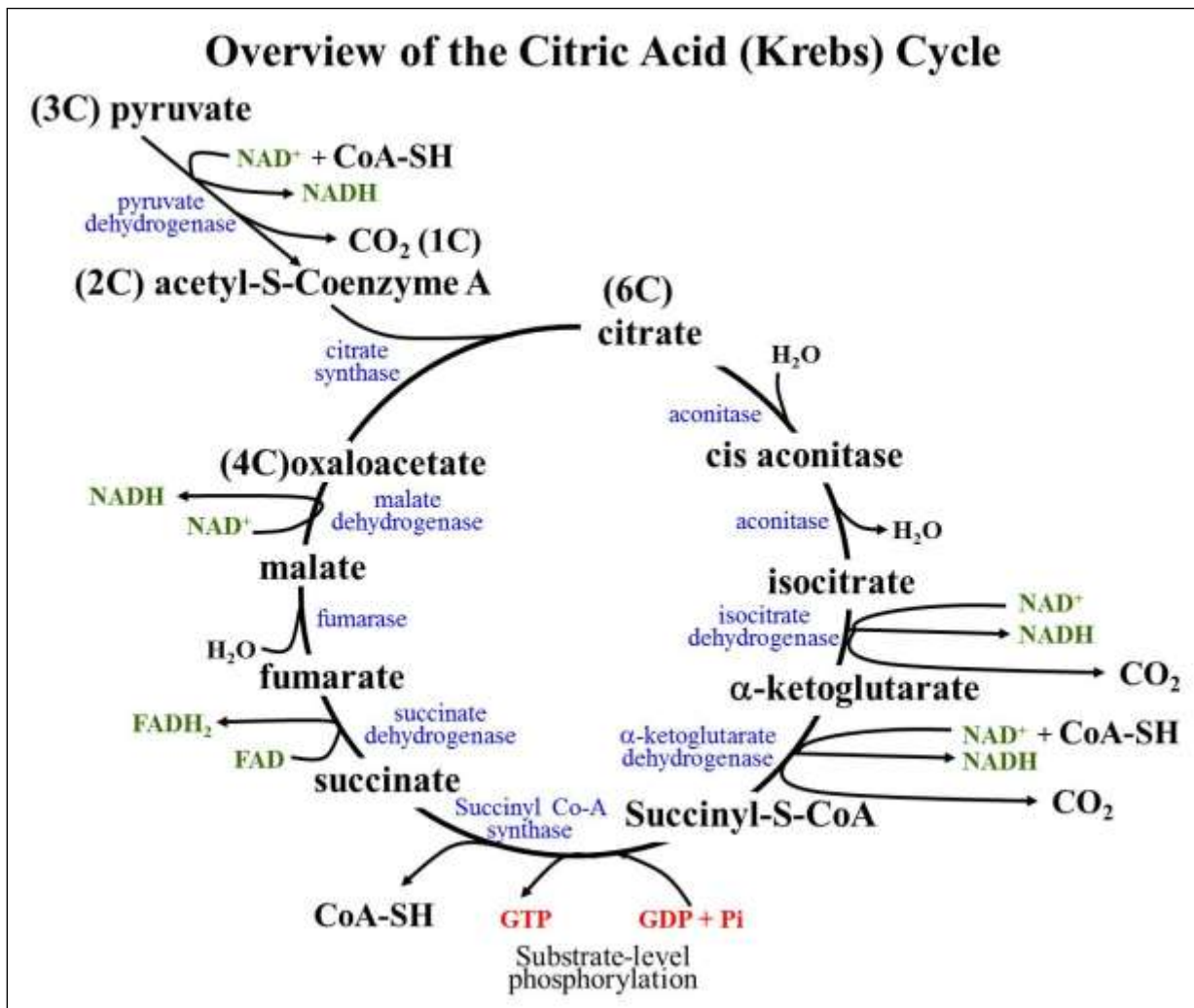

This is a pretty busy image. It begins a series of step-wise reactions with the oxidation of the 3-carbon pyruvate molecule. This generates a 2-carbon acetate (Ac-S-CoA) molecule and a molecule of CO₂. In the cycle:

- find the 2 molecules of CO₂ produced in the Krebs Cycle itself.
- find GTP (which quickly transfers its phosphate to ADP to make ATP). In bacteria, ATP is made directly at this step.
- count all of the reduced electron carriers (NADH, FADH₂). Each of the latter carries a pair of electrons, so including those on the each of the NADH molecules made in glycolysis, how many electrons have been removed from glucose during its oxidation?

Remember that two pyruvates are produced per glucose; so for each glucose, two molecules of Ac-S-CoA are produced and the cycle turns twice! Each NADH carries about 50 Kcal of the 687 Kcal of free energy originally available in a mole of glucose; each FADH₂ carries about 45 Kcal of this free energy. This energy will fuel ATP production during electron transport and oxidative phosphorylation. The *high energy thioester bonds* formed in this pathway fuel ATP synthesis as well as the condensation of oxaloacetate and acetate in the first reaction.

CHALLENGE: While you're counting stuff, try to figure out the ΔG_o for processing a mole of glucose through the Krebs cycle.

Finally, the story of how we come to understand the Krebs cycle is almost as interesting as the cycle itself! In 1937, Albert Szent-Györgyi won a Nobel Prize for discovering a few of the reactions of the cycle, which he and everyone else believed were part of a linear pathway. In that same year, Hans Krebs performed a series of elegant experiments that revealed these crucial respiratory reactions to be part of a cyclic pathway. Some of these experiments are described by Krebs and his coworkers in a classic paper: Krebs HA, et al. [(1938) *The formation of citric and α -ketoglutaric acids in the mammalian body*. Biochem. J. 32: 113–117], Click: <https://www.ncbi.nlm.nih.gov/pmc/articles/PMC1264001/> for an electronic copy of this paper. Read this classic to see the actual the evidence that led Krebs to propose the cyclic TCA pathway... and to speculations on a purpose of the pathway!. Krebs won the Nobel Prize for this work in 1953!

Some iText & VOP Key Words and Terms

Acetyl-S-coenzyme A (Ac-S-CoA)	free energy capture	oxidizing agent
ADP, ATP, GDP, GTP	fructose	phosphatase enzymes
aerobic	G, G6P, F6P, F1,6-diP	phosphate-ester linkage
anaerobic	gluconeogenesis	redox reactions
Atkins Diet	gluconeogenic amino acids	reducing agent
biochemical pathways	glycolysis	respiration
bioenergetics	glyoxalate cycle	SDH (succinate dehydrogenase)
bypass reactions, enzymes	high energy bond (linkage)	spontaneous reaction

C₆H₁₂O₆ (glucose)	high energy molecules	stage 1
cells as open systems	isomerase enzymes	stage 2
dehydrogenase enzymes	kinase enzymes	standard conditions
DHAP, G3P, 1,3-diPG, 3PG, 2PG, PEP, Pyr	Krebs (TCA, citric acid) cycle	steady state
diabetes	metabolic effects of low carb diet	stoichiometry of glycolysis
energetics of glycolysis	metformin	substrate level phosphorylation
energy flow in cells	mitochondria	Succinyl-S-CoA
equilibrium	mutase enzymes	super-catalyst
FAD (oxidized nicotinamide adenine di-Phosphate)	NAD⁺ (oxidized nicotinamide adenine di-Phosphate)	synthase enzymes
FADH₂ (reduced flavin adenine di-Phosphate)	NADH (reduced nicotinamide adenine di-Phosphate)	thioester linkage
fermentation	nutrients	ΔG' (actual free energy change)
free energy	oxidation, reduction	ΔGo (standard free energy change)

Chapter 7: Electron Transport, Oxidative Phosphorylation, Photosynthesis

Mitochondrial Electron Transport and Oxidative Phosphorylation; oxidizing NADH and FADH₂; Chemiosmotic Mechanism and Protein Motors Make ATP; Photosynthesis as a precursor to respiration; Reducing CO₂ in chloroplasts with electrons from H₂O; Light-dependent and Light-independent reactions

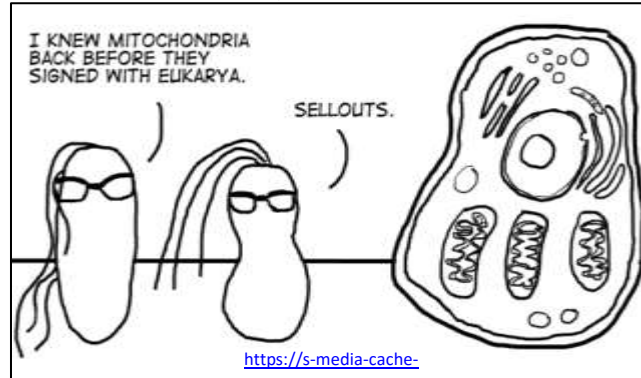

I. Introduction

We have seen that glycolysis generates 2 pyruvate molecules per glucose molecule, and that each is then oxidized to 2 Ac-S-CoA molecules. Then after each Ac-S-CoA has been oxidized by the Krebs cycle, aerobic cells have on a molar basis, captured about 30 Kcal out of the 687 Kcal potentially available from glucose. Not much for all the biochemical effort! But a total of 24 H⁺ (protons) pulled from glucose in redox reactions have also been captured, in the form of the *reduced electron carriers* NADH and FADH₂. Here we begin with a look at *electron transport* and *oxidative phosphorylation*, the linked (“coupled”) mechanism that transfers much of nutrient free energy to ATP. We’ll see how electron flow from the oxidation of electron carriers releases free energy that is first captured as an H⁺, or *proton gradient*... and how energy released as this gradient dissipates fuels ATP synthesis during oxidative phosphorylation. We’ll contrast mitochondrial oxidative phosphorylation with the substrate-level phosphorylation we saw in glycolysis and the Krebs Cycle. After presenting an energy balance sheet for respiration we look at how free energy is captured from alternate nutrients. Then we’ll discuss photosynthesis (basically the opposite of respiration) and conclude by and comparing photosynthesis and respiration.

Voice-Over PowerPoint Presentations

[Respiration: Electron Transport](#)

[Respiration: Oxidative Phosphorylation](#)

Learning Objectives

When you have mastered the information in this chapter and the associated VOPs, you should be able to:

1. explain the *centrality of the Krebs Cycle* to aerobic metabolism
2. identify the *sources of electrons in redox reactions* leading up to and within the Krebs cycle
3. illustrate the *paths of electrons* from the Krebs cycle to and through the electron transport chain
4. trace the *evolution of the electron transport chain* from its location on an aerobic bacterial membrane to its location in eukaryotic cells
5. distinguish between a *proton gate* and a *proton pump*
6. *interpret experiments* involving redox reactions, ATP synthesis and ATP hydrolysis conducted with intact mitochondria and separated mitochondrial membranes
7. interpret *pH changes* in and surrounding mitochondria resulting from such experiments
8. distinguish between the component *pH, H⁺ and electrical gradients established during electron transport and dissipated during oxidative phosphorylation*
9. explain the *chemiosmotic mechanism of ATP synthesis* and contrast it with *substrate-level phosphorylation*
10. Compare and contrast the role of electron transport in respiration and photosynthesis and discuss the evolution of each
11. Trace the paths of electrons taken in photosynthesis and explain each path
12. explain the presence of similar biochemical intermediates in respiration and photosynthesis

II. The Electron Transport Chain (ETC)

All cells use electron transport chains to oxidize substrates in free energy-releasing (*exergonic, spontaneous*) reactions. The flow of electrons through the ETC is analogous to the movement of electrons from one pole of a battery to the other (see an animation of electron flow at <http://youtu.be/PwLbYYyudZA>). In the case of the battery, the electron flow releases free energy that can power a motor, light, cell phone, etc. In the respiratory ETC, electrons flow when the reduced electron carriers produced in glycolysis and the Krebs Cycle (NADH, FADH₂) are oxidized. In plants and other photosynthetic organisms an ETC serves to oxidize NADPH (a phosphorylated version of the electron carrier NADH). In both cases, free energy released during the redox reactions of an ETC fuels the transport of protons (H⁺ ions) across a membrane, creating a proton gradient that is at once an electrical *and* a chemical gradient. This **electrochemical gradient** contains the free energy originally in the reduced substrates. This free energy released when protons are allowed to flow (diffuse) back across the membrane. This proton diffusion is **coupled** to ATP production. The energizing an electrochemical gradient and capturing the gradient free energy as ATP is called the

The Chemiosmotic Mechanism. In aerobic respiration, electrons are ultimately transferred from components at the end of the ETC to molecular oxygen (O_2), making water. In photosynthesis, electron transfer reduces CO_2 to sugars. The way in which the free energy released by these redox reactions is captured to make ATP was a mystery until Peter Mitchell proposed a chemiosmotic mechanism, for which he won the Nobel Prize in Chemistry in 1978. You can read his original proposal of the *chemiosmosis model* of mitochondrial ATP synthesis in Mitchell P [(1961) *Coupling of phosphorylation to electron and hydrogen transfer by a chemi-osmotic type of mechanism*. Nature 191:144-148].

Here we focus on the details of respiration as it occurs in the mitochondria of eukaryotic cells. The end products of electron transport are NAD^+ , FAD, water and protons, which are pumped across the cristal membrane of mitochondria to create the proton gradient. In the illustration below, roman numbered protein complexes along with Coenzyme Q (just Q in the drawing) and cytochrome C (Cyt c) are participants in a sequence of reactions in which electrons acquired by oxidizing NADH or $FADH_2$ to NAD^+ and FAD (respectively) are transferred from one complex to the next, until electrons, protons and oxygen unite to in complex IV to make water. Under standard conditions in a closed system, electron transport is downhill, with an overall release of free energy (negative ΔG_o) at equilibrium.

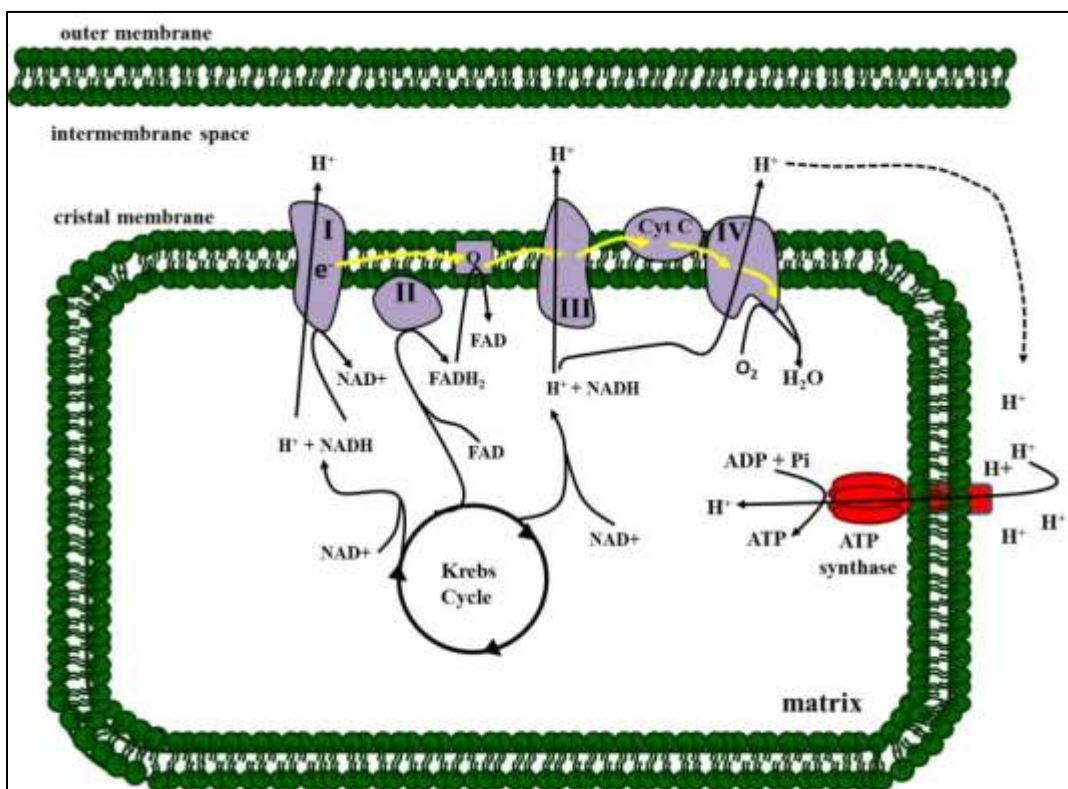

From the illustration above, we can see three sites in the respiratory ETC which function as H^+ pumps. That is, they are sites where the negative change in free energy of electron transfer is large, and coupled to the action of a proton pump. The result is that protons accumulate outside the matrix of the mitochondrion. Because the outer mitochondrial membrane is freely permeable to protons, the electrochemical gradient is in effect between the cytoplasm and the mitochondrial matrix. When the gradient is relieved by allowing the protons to flow back into the mitochondrial matrix, free energy of the gradient is released and harnessed as chemical energy.

III. Oxidative Phosphorylation

Free energy in mitochondrial proton gradient is captured as ATP by **Oxidative phosphorylation**. Most of the ATP made in aerobic organisms is made by oxidative phosphorylation, rather than by substrate phosphorylation (the mechanism of ATP synthesis in glycolysis or the Krebs Cycle). In fact, aerobic respiratory pathways evolved in an increasingly oxygenic environment because its pathways were more efficient at making ATP than fermentations such as 'complete' glycolysis.

Recall that ATP synthesis from ADP and inorganic phosphate is endergonic under standard conditions in a closed system. In substrate-level phosphorylation, the hydrolysis of very high energy nutrient intermediates of glycolysis or the Krebs Cycle is coupled to ATP synthesis. In oxidative phosphorylation, the controlled diffusion of protons across the cristal membrane into the mitochondrial matrix is coupled to ATP synthesis on a complex of proteins and enzymes called an **ATP synthase**.

As we have seen, the movement of electrons down the electron transport chain fuels 3 proton pumps that establish a proton gradient across the *cristal* membrane. Free energy is stored in this (in fact in any) gradient. Oxidative phosphorylation is the system that evolved to couple proton flow into the mitochondrial matrix to the capture of proton gradient-free energy. Because protons carry a positive charge, the gradient produced is also an *electrochemical* one. We say that the proton gradient has a *proton-motive force*. It has two components: a difference in proton concentration (a H^+ gradient, or ΔpH) and a difference in electric potential. The cell controls when the energy stored in this proton gradient will be released to make ATP. The switch that allows protons to flow across the cristal membrane to relieve the proton gradient is an *ATP synthase*, a tiny, complex protein motor. For a clear discussion of this complex enzyme, Read the article by P. D. Boyer [(1997) *The ATP synthase – a splendid molecular machine*. Ann. Rev. Biochem. 66:717-749].

The capture of free energy of protons flowing through the complex is summarized below.

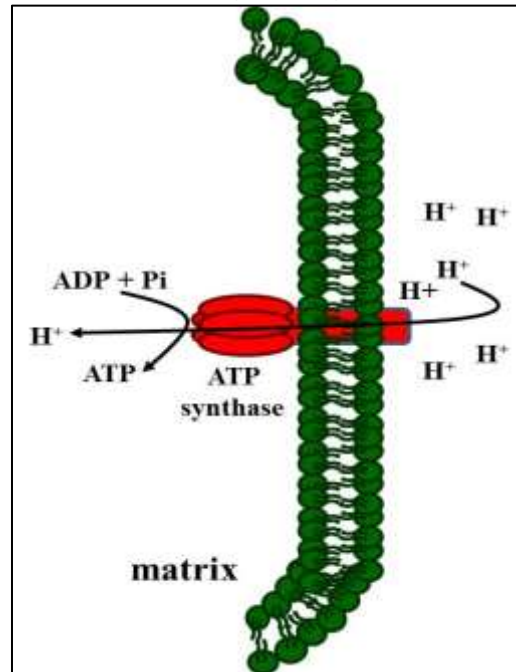

In mitochondria, the protons that are **pumped** out of the mitochondrial matrix using the free energy released by electron transport can flow back into the matrix through the *ATP synthase*. If there are 3 ETC **proton pumps** in the cristal membrane, then the cristal membrane ATPase complexes function as **proton gates** that catalyzes ATP synthesis from ADP and inorganic phosphate when protons are allowed to flow through them. For their discovery of the details of ATP synthase function, P. D. Boyer and J. E. Walker shared the Nobel Prize in Chemistry in 1997.

Proton flow through the gates is regulated. When ATP is high (meaning that the cells energy needs are being met), the gate is closed and the proton gradient cannot be relieved. But if ADP levels are relatively high (a signal that the cell is hydrolyzing a lot of ATP... and needs more), the gate will open. As protons diffuse through the gate, they power a molecular (protein) motor in the ATP synthase that in turn, activates ATP synthesis.

A very similar electron transport chain exists in the cell membrane of bacterial, which of course lack mitochondria, but which according to the *endosymbiotic theory*, are the ancestors of mitochondria. The *chemiosmotic mechanism* of ATP generation in aerobic bacteria is therefore much the same as in eukaryotic mitochondria.

Proton gradients not only power ATP synthesis, but in some cases, can power cellular activities more directly. The best example of this is the bacterial flagellum that is directly attached to the molecular motor of a proton gate protein complex in the cell membrane (below).

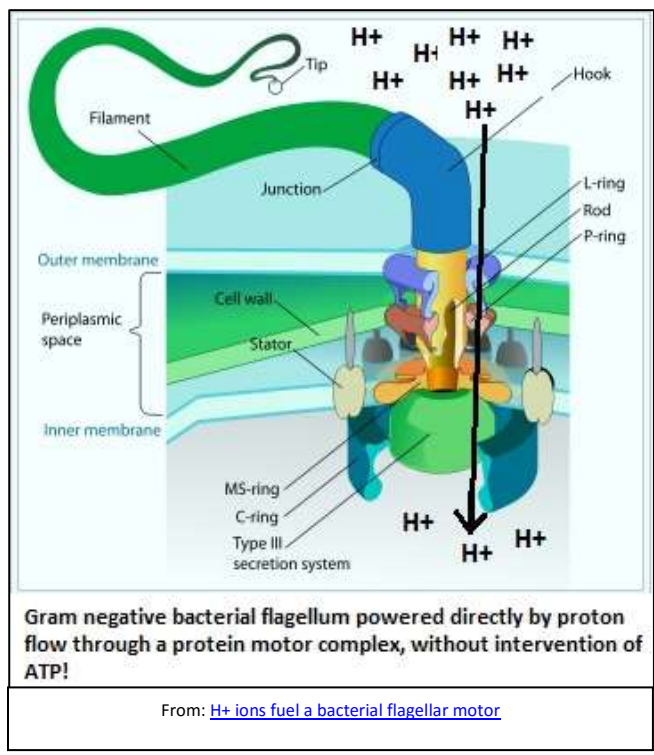

Electron transport in the cell membrane creates the gradient, and relief of the gradient directly powers the flagellum.

IV. Photosynthesis

Chemically, photosynthesis is the reverse reaction of respiration. Compare the two reactions:

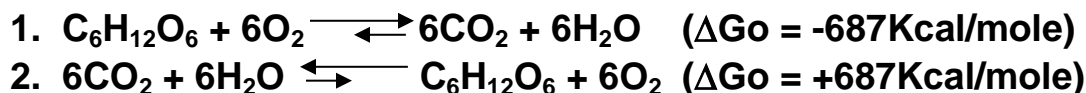

If respiration (reaction 1) is the complete oxidation of glucose to H_2O and CO_2 , then photosynthesis (reaction 2) is the reduction of CO_2 using electrons from H_2O .

Photosynthesis is an *endergonic* pathway; sunlight (specifically visible light, fuels the reduction of CO₂ (summarized below).

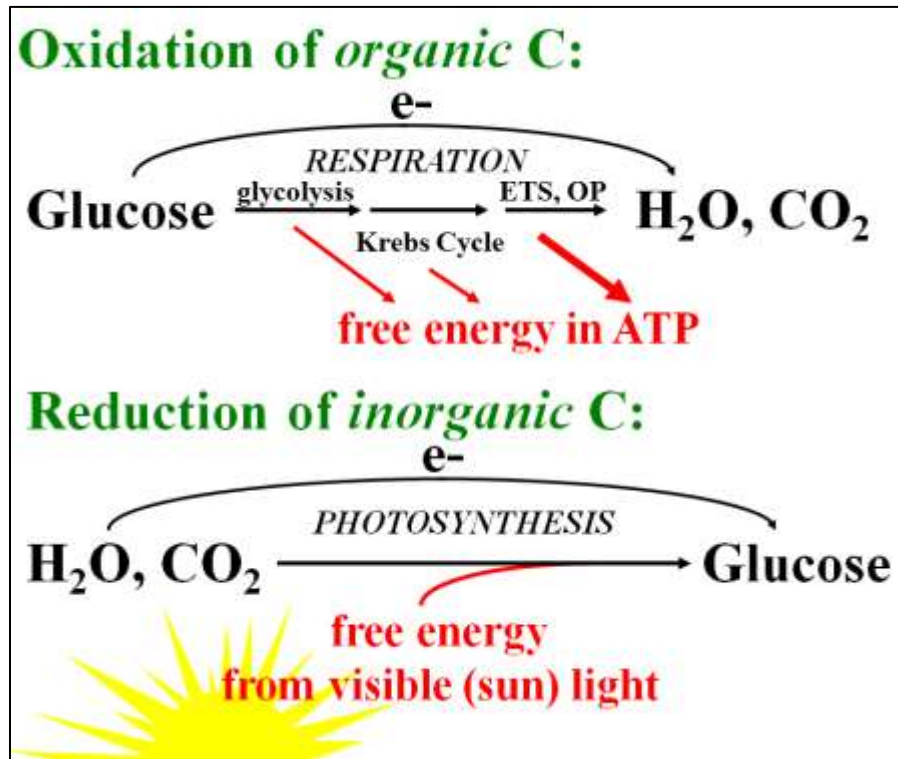

The evolution of photosynthesis could only have occurred before the advent of respiration, since it is photosynthesis that began generating the molecular oxygen that characterizes our atmosphere today. If we look at photosynthesis in some detail, we will see an electron transport system that pumped protons and coupled gradient free energy to ATP synthesis, one that evolved before the respiratory pathways, and that might have been the source of respiratory pathway reactions in evolution later in evolution.

Photosynthesis is basically two pathways:

- **Light-dependent reactions** that use visible light energy to remove electrons from water and reduce electron carriers, and to make ATP;
- **Light-independent reactions** that use ATP to transfer electrons from the reduced electron carriers to CO₂ to synthesize glucose.

The two pathways are summarized below.

Photosynthesis has light-dependent & light-independent components:

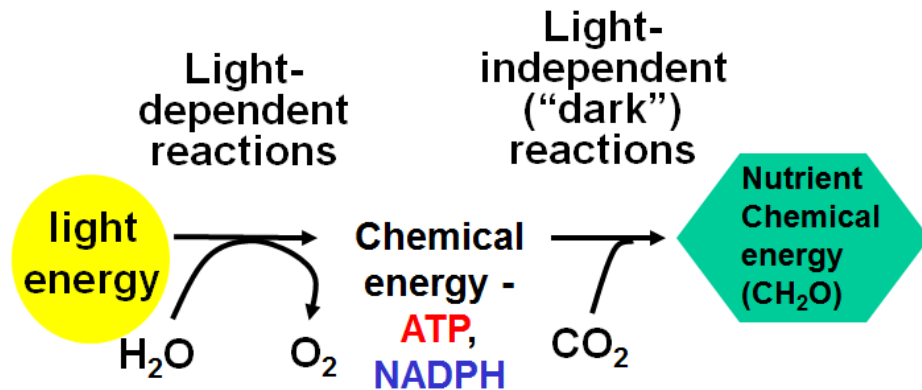

A. The Light Dependent Reactions

An early experiment (below) established that only wavelengths of visible light energy functioned in photosynthesis, and that in fact, most wavelengths (colors) of light would stimulate photosynthesis in plants.

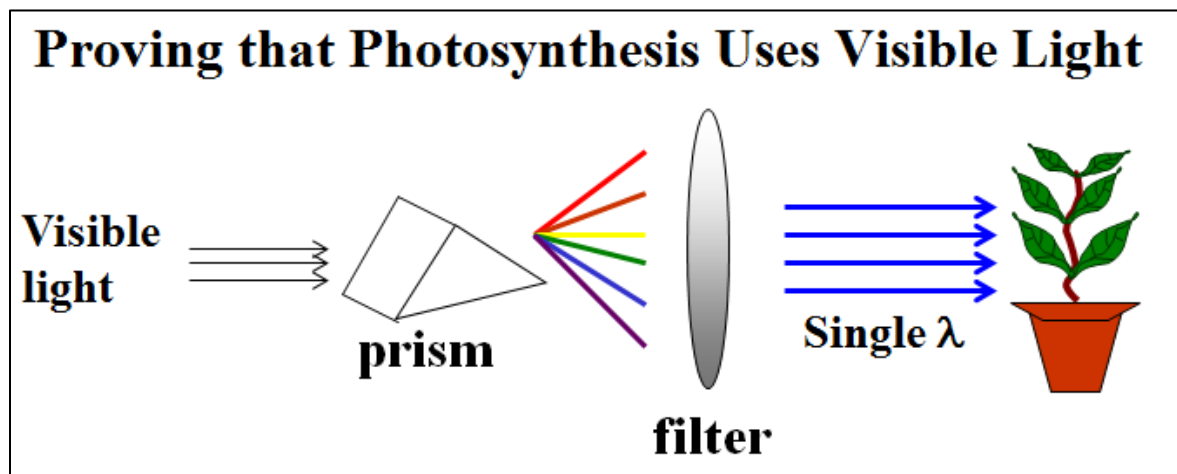

In this experiment different wavelengths of light were shone on plants and the rate of photosynthetic reactions was measured as an indicator of photosynthetic action, with the results graphed as an **action spectrum** (below).

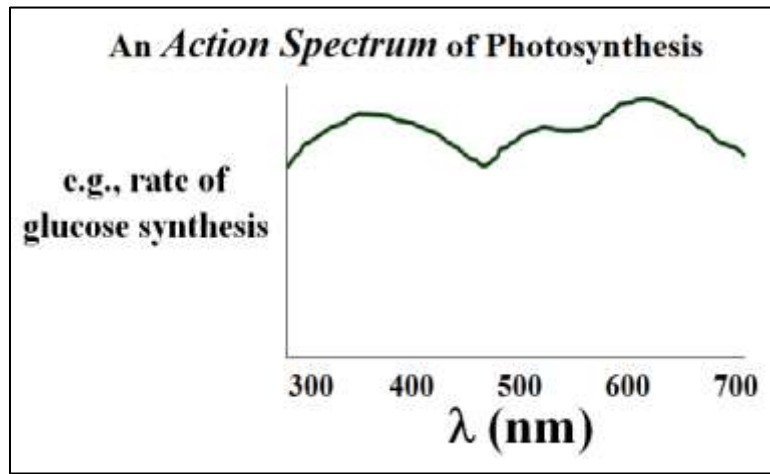

Substances we see as colored contain **pigments** that reflect the colors that we see and absorb all the colors of visible light. Thus chlorophyll, the most abundant pigment we see in plant tissues should be among the pigments that absorb light energy to power photosynthesis. Chlorophyll is actually two separate green pigments, **chlorophyll a** and **chlorophyll b**. The **absorbance spectrum** below reveals that *chlorophyll a* purified from leaves absorbs light in only two wavelength regions, centering around 350 and 675nm.

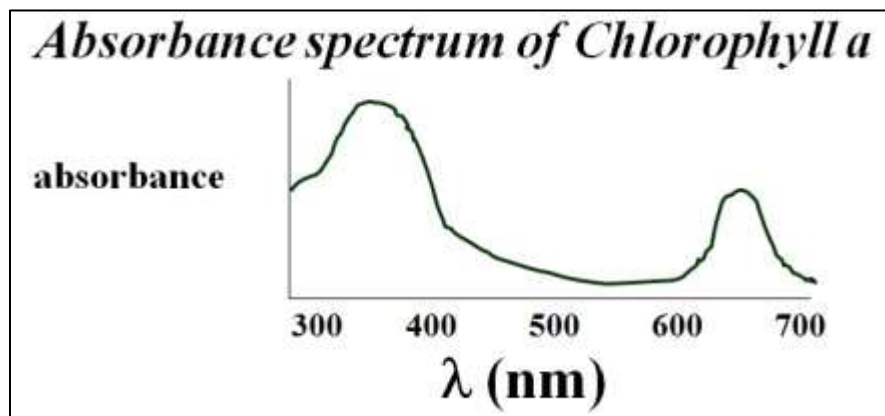

The conclusion was that absorbance of light by chlorophyll a could not explain the photosynthetic action spectrum, which indicated that light of many wavelengths across the visible light spectrum can support photosynthesis. In fact, we knew that leaves and

other photosynthetic plant tissues contained a variety of different pigments, many of which we see as fall colors. These pigments are found in **chloroplasts**, the organelles that conduct photosynthesis in plants.

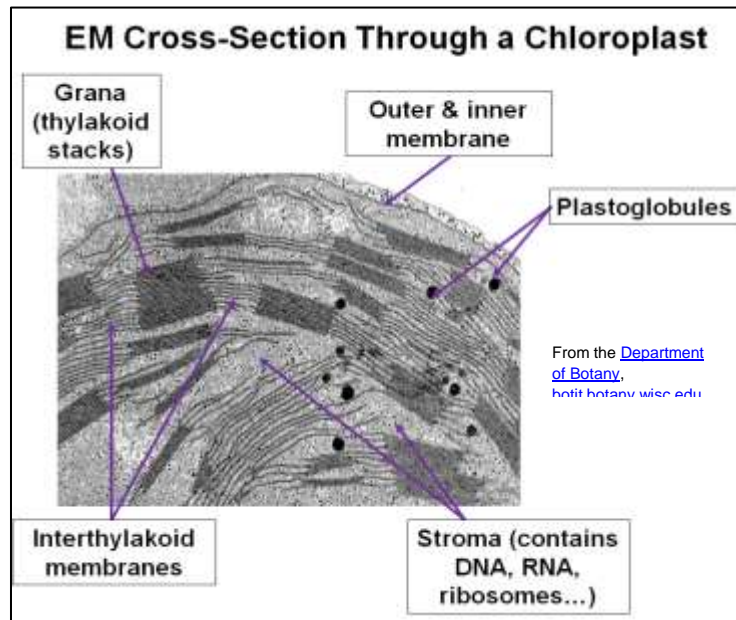

Below are the absorbance spectra of three plant pigments, whose absorbance supports photosynthesis and whose spectra span most of the visible light spectrum.

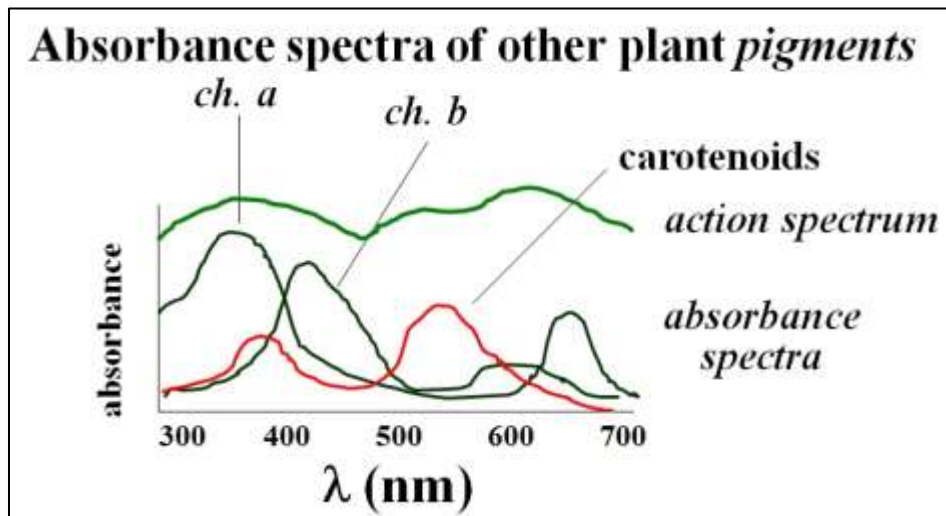

Carotenoids, chlorophyll b and other **accessory pigments** participate in capturing light energy for photosynthesis. The two clusters of pigments that capture light energy are

reaction centers that are part of **photosystems 1 and 2** on **thylakoid membranes** of **chloroplasts**. Johann Deisenhofer, Robert Huber and Hartmut Michel shared the 1988 Nobel Prize in Chemistry for determining the 3D structure of a bacterial reaction center by unraveling the relationship of the structure of the proteins in the center and the membrane in which they were embedded.

The activities of Photosystem I are animated at http://youtu.be/BLEB0A_9Tt4. You should see light (a photon) excite electron (e-) pairs excited from Photosystem I pigments that then transfer their energy from pigment to pigment, ultimately to chlorophyll a P700, from which an e-pair is excited and captured by a photosystem I (PSI) e- acceptor. The reduced PSI acceptor is then oxidized with its electrons transported along a short ETC, eventually reducing NADP+ to NADPH. Electrons on NADPH will eventually be used to reduce CO₂ to a carbohydrate. So far, so good! But that leaves an e- deficit in Photosystem I. The Z-Scheme illustrated below follows electrons as they are *taken from water* (absorbed through roots) and used to replace those missing from PSI.

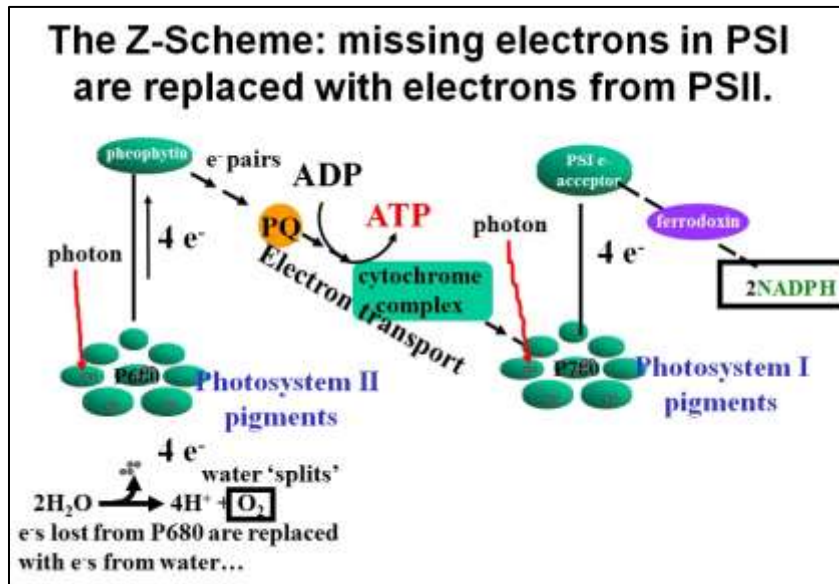

After electrons from PSI reduce NADP⁺ to NADPH, they are replaced with electrons excited by light from PS2. The electrons excited in PS2 are ultimately excited from the **P680** form of chlorophyll a, and are captured by a PSII electron acceptor in the thylakoid membrane, which has been identified as **pheophytin**. When pheophytin is oxidized, its electrons move to PSI down an ETC in the thylakoid membrane. Some of the free energy released by electron transport is used to pump protons from the *stroma* into the space surrounded by the thylakoid membranes. When the protons are allowed to flow back into

the stroma, the gradient free energy is coupled to ATP synthesis by a chloroplast **ATP synthase**. The link at <http://youtu.be/t4RIsDDsNi8> animates the entire Z-Scheme, showing first how PSI electrons reduce NADP+ and then how PSII electrons replace missing PSI electrons, making ATP along the way. The oxygen released by splitting water ends up in the atmosphere.

CHALLENGE: To help you get a handle on the Z-scheme, list all the products of the light reactions of photosynthesis.

B. Cyclic Photophosphorylation

The Z-Scheme does not in fact make enough ATP to power the Calvin Cycle. But when the need for ATP exceeds the capacity of the tissues to make sugar, the photosynthetic apparatus can *take a time-out*, resorting to **Cyclic Photo-phosphorylation** for a while.

Cyclic Photophosphorylation simply takes electrons excited to the PSI electron acceptor, and instead of sending them to NADP+, deposits them on PC (*plastocyanin*) in the electron transport chain between PSII and PSI. These electrons then flow down this ‘long line’ of the Z, right back to PSI, releasing their free energy to make ATP. In light, the electrons just go up and around, hence the name *Cyclic Photophosphorylation*. The pathway of electrons is shown in blue below and is animated at this link: <http://youtu.be/T6HfiwC0eul>.

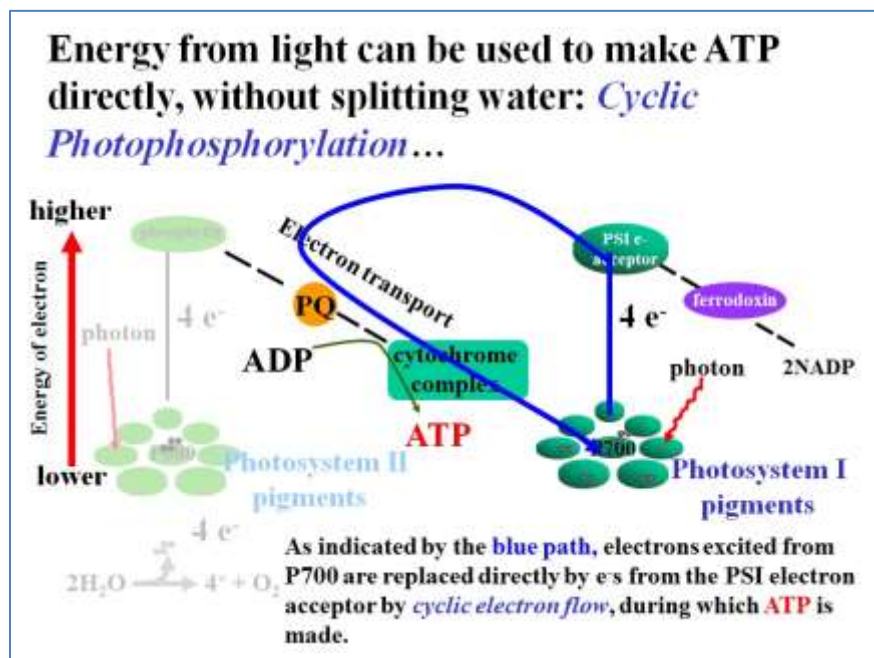

C. The Light-Independent (“Dark”) Reactions

1. *The Dark reactions of C3 photosynthesis*

As we have seen, the light-dependent reactions of photosynthesis require light energy and water and generate O₂, ATP and NADPH. In the **light-independent** (or ‘**dark**’) reactions, the ATP and NADPH will provide free energy and electrons (respectively) for carbon fixation, the reduction of CO₂ to make carbohydrates (i.e., glucose). CO₂ enters photosynthetic tissues through **stomata**. Stomata are pores in leaves that can be open or closed, depending on light, temperature conditions and water availability. In addition to allowing CO₂ into photosynthetic tissues, stomata also function in **transpiration**, which allows excess water in cells to leave the plants and evaporate, a process sometimes called *evapotranspiration*.

C3 photosynthesis is the mechanism of *carbon fixation* used by most plants. It’s called C3 because its first carbohydrate product is a 3-carbon molecule, 3-phosphoglyceric acid (3-PG), which you will recognize is also a glycolytic intermediate. The most common dark reaction pathway is the Calvin Cycle, (check the animation at <http://youtu.be/XtzExh3I17c>). Named for its discoverer, this cycle earned M. Calvin the Nobel Prize in Chemistry in 1961. Each carbon dioxide entering the Calvin cycle is “fixed” to a 5-carbon *ribulose biphosphate* molecule (RuBP), catalyzed by the enzyme **RuBP carboxylase-oxygenase**, or **Rubisco** for short. The expected 6-C molecule must be so quickly split into two 3-C molecules that it has not been detected as an intermediate to date! The first detectable products are two molecules of 3-phosphoglyceric acid, each of which is reduced to glyceraldehyde-3-phosphate (G-3-P).

The cycle regenerates the RuBP **and** produces glucose. Perhaps the easiest way to see this is to imagine the cycle going around 12 times, fixing 12 molecules of carbon dioxide, as shown in the link. Two of the G-3-P molecules are linked together to make a single 6-C molecule of glucose (which in plants during the day is polymerized into starch for storage). That leaves 10 molecules of G-3-P (a total of 30 carbons). The latter part of the cycle will regenerate 5 molecules of new RuBP (30 carbons!).

2. *Photorespiration*

But there are times that even plants in temperate environments suffer prolonged hot, dry spells... perhaps you have seen a lawn grow more slowly and turn brown after a dry heat wave in summer, only to re-green and grow again after the rains resume. C3 plants resort to **photorespiration** during drought and dry weather, closing their stomata to conserve water. Under these conditions, CO₂ cannot get into the leaves...

and O₂ can't get out! As CO₂ levels drop and O₂ rise in photosynthetic cells, the Calvin Cycle slows down and instead of fixing CO₂ the enzyme **Rubisco** catalyzes "O₂ fixation" using its *oxygenase* activity. The combination of RuBP with O₂ splits RuBP into one 3-carbon and one 2-carbon molecule: **3-phosphoglyceric acid** (3-PG) and **phosphoglycolate** respectively. The reaction is shown below.

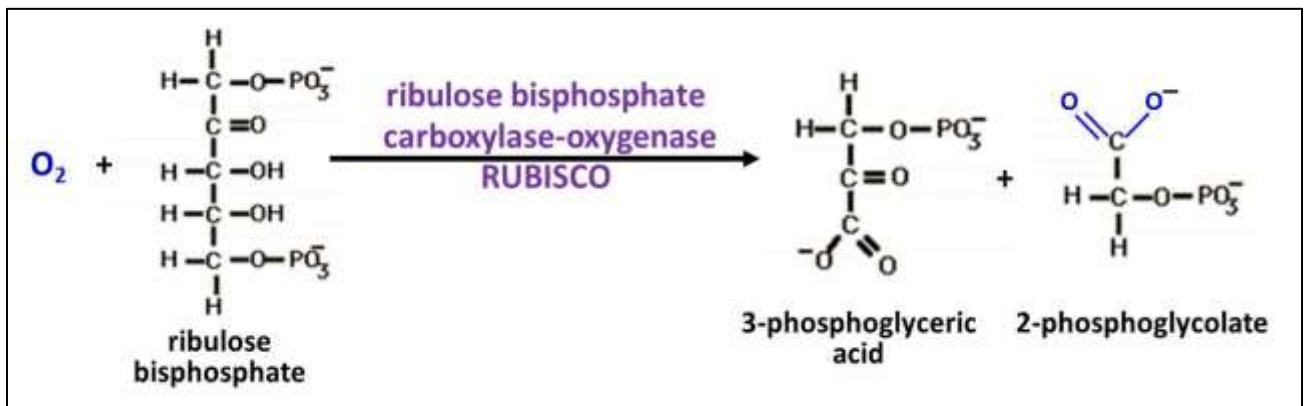

Not only does photorespiration result in only one 3-carbon carbohydrate (compared to two in the Calvin Cycle), but the phosphoglycolate produced is *cytotoxic*. Removing the phosphate and metabolizing the remaining glycolic acid will cost the plant energy, and can only be sustained for a limited time.

On the other hand, plants that have adapted to live in hot arid environments all the time have evolved one of two alternate pathways, **CAM (Crassulacean Acid Metabolism)** or **C4** metabolism, each of which is an alternative to the C3 carbon fixation pathway.

3. The CAM Photosynthetic Pathway

CAM, or *crassulacean acid metabolism* was first discovered in the Crassulaceae, plants that include succulents like sedum (a common ground cover), cactuses and jade plants, as well as some orchids. The CAM pathway was selected in evolution to allow plants to conserve water, especially during the day, when high temperatures would cause other plants to lose too much water. In CAM plants, leaf stomata close during daylight hours to minimize water loss by *transpiration*. At night the stomata open, allowing plant tissues to take up CO₂. Acid metabolism involves *fixing* CO₂ by combining with **PEP (phosphoenol pyruvate)**, leading eventually **malic acid** which is stored in vacuoles in the plant cells. During the daytime, the stored malic acid retrieved from the vacuoles enters chloroplasts, where it is split into pyruvate and CO₂.

The latter then enters the Calvin Cycle to make glucose and the starches. The CAM pathway is described below.

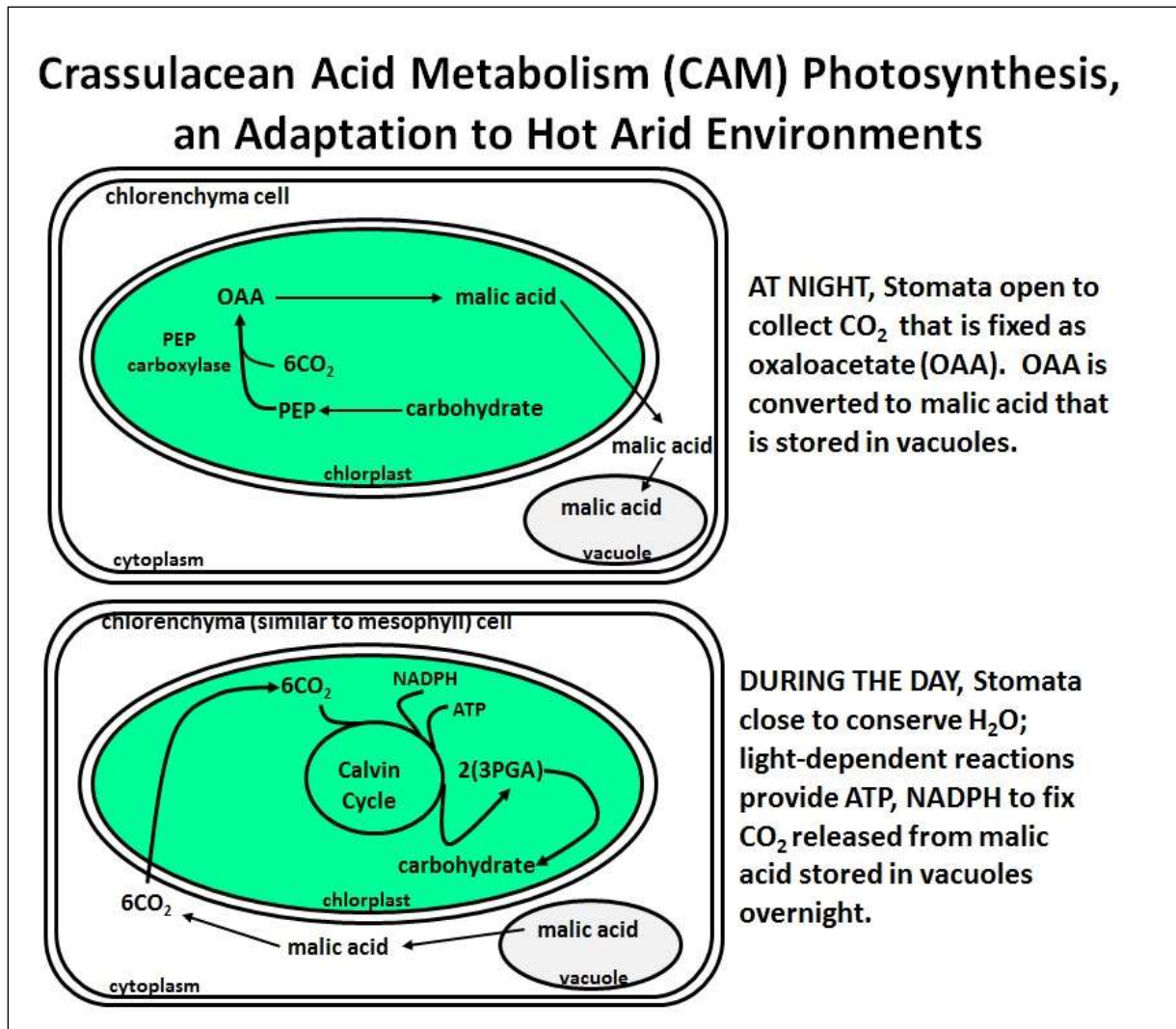

In sum, the CAM plants

- open stomata to collect, fix and store CO_2 as an organic acid at night.
- close stomata to conserve water in the daytime.
- re-fix the stored CO_2 as carbohydrate using the NADPH and ATP from the light reaction the next the day.

4. The C4 Photosynthetic Pathway

C4 refers to the 4-carbon end-product of CO₂ fixation, which is in fact the same as in CAM metabolism; malic acid! As in the CAM pathway, PEP carboxylase is the catalyst of carbon fixation in C4 metabolism that converts phosphoenol pyruvate (PEP) to oxaloacetate (OAA) that is then reduced to malic acid, as shown below.

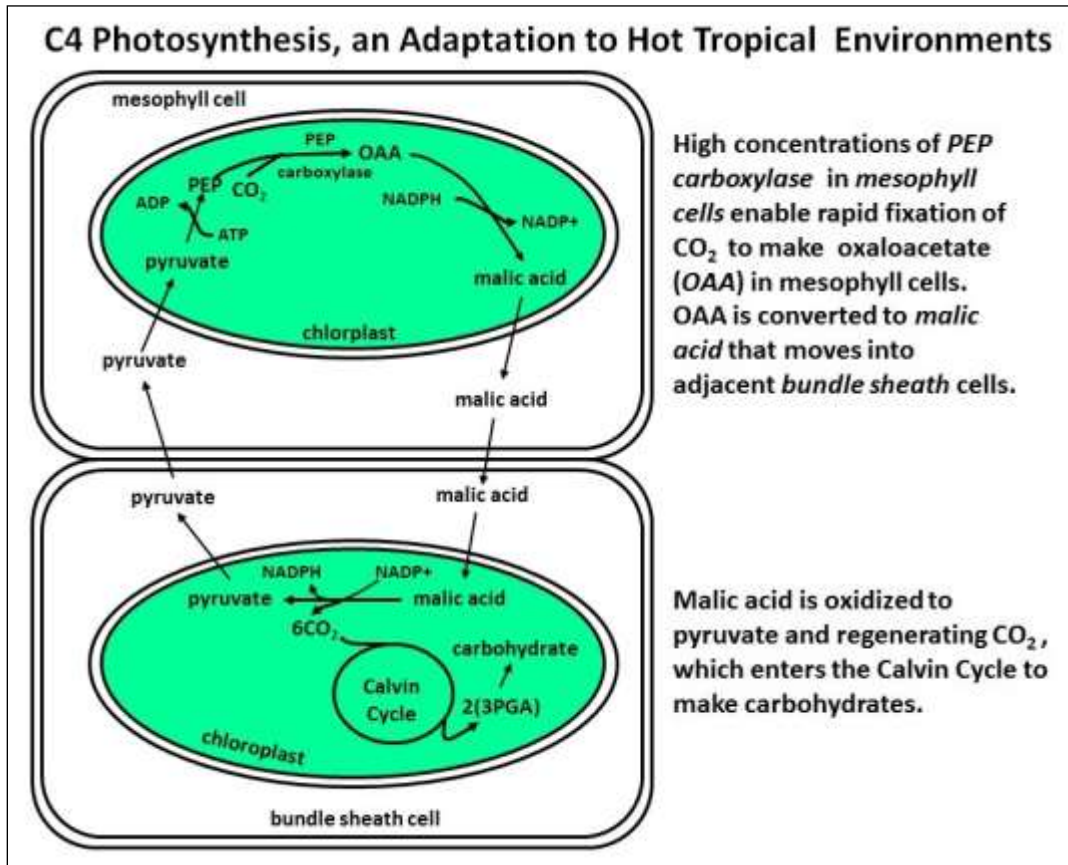

PEP carboxylase catalysis rapid, in part because malic acid does not accumulate in the **mesophyll** cells, but instead is rapidly transferred to adjacent **bundle sheath** cells. The result is that CO₂ fixation is more efficient than in CAM plants. This in turn allows C4 plants to keep stomata open for CO₂ capture (unlike CAM plants), but closed at least part of the day to conserve water. As the 4-carbon malic acid is oxidized to pyruvate (3 carbons!) in the bundle sheath cells, CO₂ is released directly to Rubisco for rapid fixation by the Calvin Cycle. This system allows more efficient water use and faster carbon fixation under high heat, dry conditions than does C3 photosynthesis. Corn is perhaps the best known C4 plant!

V. More Thoughts on the Mechanisms and Evolution of Respiration and Photosynthesis.

We can assume that the abundance of chemical energy on our cooling planet favored the formation of cells that could capture free energy from these nutrients. These first cells would have extracted nutrient free energy by non-oxidative, fermentation pathways. And they would have been voracious feeders, quickly depleting their environmental nutrient resources. But for the evolution of at least some autotrophic life forms, life would have reached a dead end! Phototrophs that could capture free energy directly from light (i.e., the sun) would soon have become the most abundant autotrophs, if for no other reason than sunlight is ubiquitous and always available (at least during the day). To conclude, photosynthesis existed before respiration. Therefore one might ask whether and when respiration co-opted photosynthetic electron transport reactions that captured the electrons from H₂O needed to reduce CO₂, turning those reactions to the task of burning sugars back to H₂O and CO₂. Perhaps the resulting respiratory chemistry evolved (i.e., spread) first in places and at times when small amounts of oxygen threatened oxidative damage to otherwise anaerobic cells. Based on gene sequence analysis, the endosymbiotic critter that became the first mitochondrion in a eukaryotic cell was not just any aerobic bacterium, but in fact a purple, photosynthetic bacterium whose electron transport chain lost the ability to do photosynthesis!

Some iText & VOP Key Words and Terms

active transport of protons	energy efficiency of glucose metabolism	PEP carboxylase
ATP synthase	energy flow in glycolysis	pH gradient
bacterial flagellum	energy flow in the Krebs Cycle	pheophytin
C4 photosynthesis	F1 ATPase	photosynthesis
Calvin Cycle	FAD	Photosystems
CAM photosynthesis	FADH ₂	proton gate
carotene	Light-dependent reactions	proton gradient
chemiosmotic mechanism	Light-independent reactions	proton pump
Chlorophyll a	Malic acid	PSI electron acceptor

Chlorophyll b	mitochondria	PSII electron acceptor
Coenzyme Q (CoEQ)	molecular motor	redox reactions
complex I, II, III, IV	NAD⁺	reduced electron carriers
Crassulaceae	NADH	RUBISCO
cristal membrane	NADP⁺	RuBP
Cyclic photophosphorylation	NADPH	Splitting water
cytochromes	outer membrane	stoichiometry of glycolysis
Dark Reactions	oxidative phosphorylation	stoichiometry of the Krebs Cycle
electrochemical gradient	oxidative phosphorylation	substrate-level phosphorylation
electron transport system (chain)	P₆₈₀	Z-scheme
endosymbiotic theory	P₇₀₀	

Chapter 8: DNA Structure, Chromosomes, Chromatin, Replication and DNA Repair

The Double Helix; Chromosomes and Chromatin; Semi-Conservative Replication; Replication Details; DNA Repair

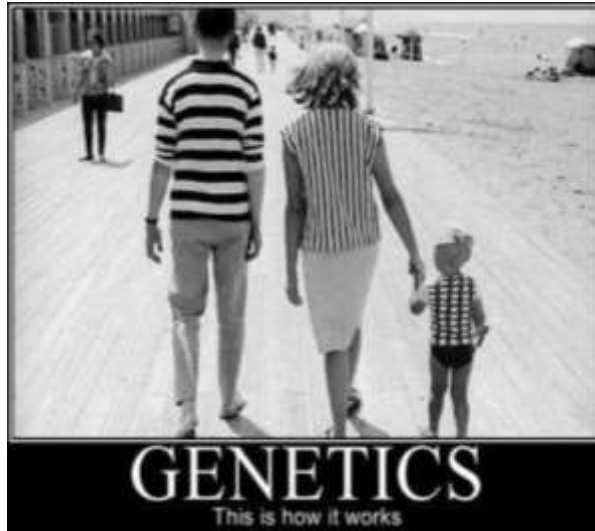

<http://media-cache-ak0.pinimg.com/736x/5d/11/50/5d115093632874736d8609fd2015ef47.jpg>

I. Introduction

In this chapter we look first at classic experiments that led to our understanding that genes are composed of DNA. Then we look at the equally classic work of *Watson, Crick, Franklin* and *Wilkins* that revealed the structure of the genetic molecule. Since genes had been mapped to chromosomes since early in the 20th century, it was clear that genes made up of DNA would be on chromosomes, so one section of this chapter looks at this association. But chromosomes are a very discrete highly *condensed* structures in eukaryotic cells that are visible only while the cells are dividing (i.e., during mitosis or meiosis). At other times, during the much longer interphase portion of the cell cycle, the DNA exists as part of a chromatin, a less organized form of chromosomal material in the nucleus. In both chromosomes and chromatin, DNA is associated with nuclear proteins. As we will see here and in a later chapter, understanding the organization of DNA and proteins in chromatin is vital to our understanding of how and when genes are expressed (turned on and off). Therefore, another section of the chapter looks at DNA as part of chromatin. Then we'll look at the molecular mechanisms of replication. We'll see experiments done initially in bacteria, whose DNA is basically just a circular DNA molecule that is not wrapped up in proteins or RNA. The mechanisms to be described for this 'naked' prokaryotic and for replication of eukaryotic DNA surrounded by proteins will differ precisely because of these differences in DNA *packing*.

Nevertheless, the molecular details of the process are quite similar overall, speaking to an early and common evolutionary origin of replication. Replication is error-prone, though these errors in fact leave behind the very mutations that allow selection in evolution. Nevertheless, replication is made more faithful by several mechanisms of DNA repair. Some of these mechanisms share enzymatic and structural features with transposition. Transposable elements are a large portion of typical eukaryotic genomes, so we will conclude this chapter with a look at the different kinds of transposons and how they “jump”.

Voice-Over PowerPoint presentations

[DNA-The Stuff of Genes](#)

[DNA Structure](#)

[DNA & Chromosomes](#)

[DNA & Chromatin](#)

[Replication Part 1](#)

[Replication Part 2](#)

Learning Objectives

When you have mastered the information in this chapter and the associated VOPs, you should be able to:

1. discuss how Erwin Chargaff’s data on the *base ratios* in DNA from different species is consistent with DNA as the “stuff of genes”
2. describe the experiments and interpret the results of Griffith, Avery et al. and Hershey & Chase, each in the context of when the experiments were done
3. state evidence that led to acceptance that genes are made of DNA and not proteins
4. list and explain the evidence Watson and Crick used to build their model of DNA
5. describe the organization of DNA in chromatin and chromosomes
6. speculate on how this organization impacts replication
7. list the key “actors” (proteins and enzymes) required for replication
8. describe the actions and activities of proteins and enzymes required for replication
9. define a *viral infection*
10. trace the fate of $^{35}\text{SO}_4$ (*sulfate*) into proteins synthesized in cultured bacteria
11. compare and contrast the structure and functionality of different forms of *chromatin*
12. outline an experiment to purify *histone H1* from chromatin
13. formulate an *hypothesis* for how histones evolved in eukaryotes and not in bacteria

II. The Stuff of Genes

By the late 19th century, the nucleus was known to be a major feature common to all eukaryotic cells. By the dawn of the 20th century, the nucleus was thought likely to be the seat of genetic information. At the same time, nuclei were shown histologically to be made up mainly of proteins and DNA. Albrecht Kossel received the 1910 Nobel Prize in Physiology or Medicine for his discovery of the 4 DNA bases, as well as Uracil (in RNA)! At that time, DNA was believed at that time to be a small molecule made up of only the four nucleotides (see DNA Structure below for a bit more historical perspective). Following the re-discovery of Mendel's Laws of Inheritance at about the same time, the number of known inherited traits in any given organism increased rapidly. If DNA was so small and simple a molecule, it could not account for the inheritance of so many different physical traits. The recognition that enzyme activities were inherited, just like morphological characteristics led to the **one-gene-one enzyme** hypothesis that earned G. W. Beadle, E. L. Tatum and J. Lederberg the 1958 Nobel Prize for Physiology and Medicine..

When enzymes were shown to be proteins, the hypothesis became *one-gene-one protein*, and when proteins were shown to be composed of one or more polypeptides, the final hypothesis was *one-gene-one-polypeptide*. Because polypeptides were found to be long chains of up to 20 different amino acids, polypeptides and proteins had the potential for enough structural diversity to account for the growing number of heritable traits in a given organism. Thus proteins seemed more likely candidates for the molecules of inheritance. The experiments you will read about here occurred from the beginning of World War I and lasted until just after World War 2. During this time we learned that DNA was no mere tetramer, but was in fact a long polymer. We'll see how some very clever experiments eventually forced the scientific community to the conclusion that DNA, not protein, was the genetic molecule, even with only 4 monomeric units.

A. Griffith's Experiment

Fred Neufeld, a German bacteriologist studying pneumococcal bacteria in the early 1900s discovered 3 immunologically different strains of *Streptococcus pneumonia* (Types I, II and III). The virulent strain (Type III) was responsible for much of the mortality during the **Spanish Flu** (influenza) *pandemic* of 1918-1920. This pandemic killed between 20 and 100 million people, mostly because the influenza viral infection weakened the immune system of infected individuals, making them susceptible to bacterial infection by *streptococcus pneumonia*. In the 1920s, *Frederick Griffith* was working with the **wild type** virulent (Type III) and a **benign** (Type II) strain of this bacterium to explore whether the Type II strain cells could immunize mice against the virulent strain. The two strains were easy to tell apart because the virulent strain grew in morphologically *smooth colonies*,

while the benign strain formed *rough colonies*. We now know that the smooth-colony forming cells are coated with a polysaccharide capsule that makes colonies look smooth to the naked eye, while the rough colony cells grow into colonies that do not shine, and look rough because they lack the polysaccharide coating. The polysaccharide capsule protects the virulent cells from the infected host organism's immune system. Lacking the polysaccharide coat, the R cells are attacked and cleared by the host cell's immune system before a serious infection can take hold. The experimental design and results that Griffith published in 1928 are summarized in this illustration.

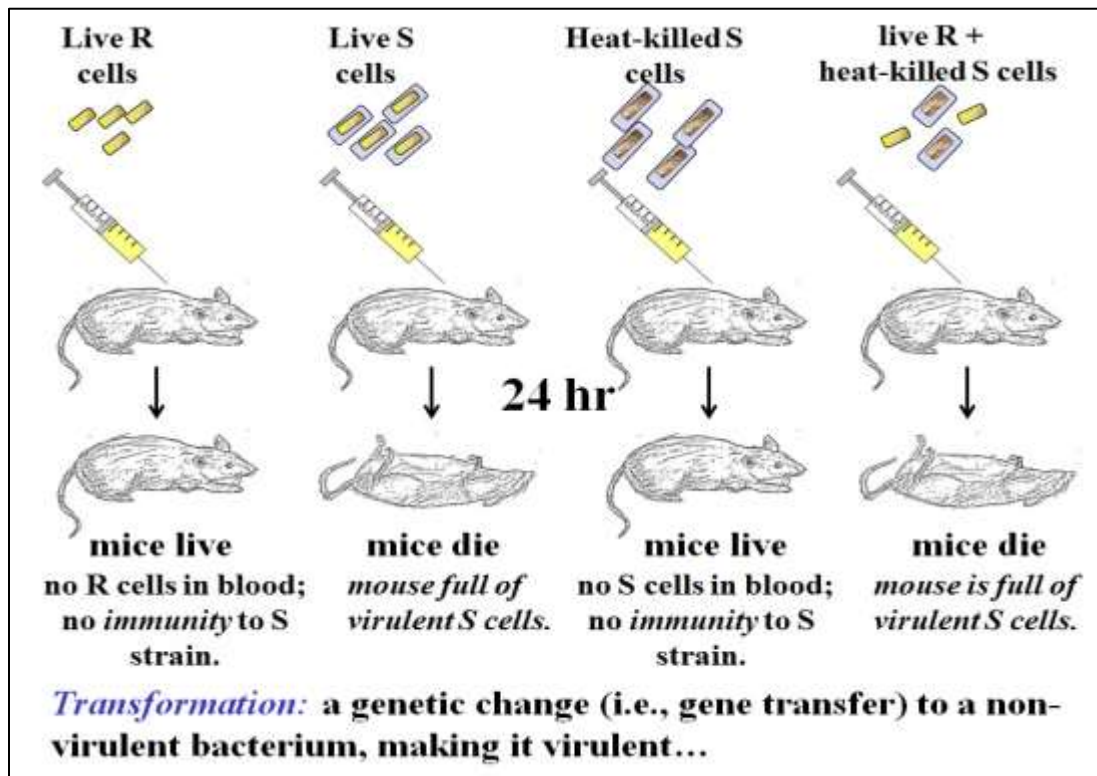

In the experiment, mice injected with benign (**R**, or rough) strain cells survived, and no bacterial cells were found thereafter in the blood of these mice. Mice injected with virulent (**S**, or smooth) strain cells died after a day, and their blood was full of S cells. As expected, if a colony of S cells was heated to kill them before injecting them into mice, the mice survived, and contained no bacterial cells in their blood. This result was “expected” because heating had the same effect on the *S cells* as pasteurization had on bacteria in milk!

In one experiment, Griffith injected a *mixture of live R cells and heat-killed S cells*, presumably in the hope that the combination would induce immunity on the mouse. You can imagine his surprise when the injected mice died after a day and that their blood was

filled with S cells. Griffith realized that something important had happened in his experiments, namely that in the mix of live R cells and heat-killed S cells, some R cells had become **transformed** by something from the dead S cells. **Bacterial transformation** is in fact the acquisition of a genetic molecule (Griffith called it the **transforming principle**) from the S cell debris by the live R cells. Thus, the transformation made some of the R cells virulent. Griffith's experiment opened the way to experiments establishing that DNA, and not protein, is the "stuff of genes".

CHALLENGE: Of all the R cells initially injected into a healthy mouse, how many do you think would have to acquire the *transforming principle* from dead S cells to account for the death of the mouse so quickly? Explain your answer.

B. Avery-MacLeod-McCarty Experiment

A technique developed in the 1930's demonstrated that R cells could be transformed *in vitro*, that is, without the help of a mouse. With this technique, O. Avery, C. MacLeod, and M. McCarty reported purifying heat-killed S-cell components (DNA, proteins, carbohydrates, lipids...) and separately testing the transforming ability of each molecular component on R cells. Their experiment is summarized below.

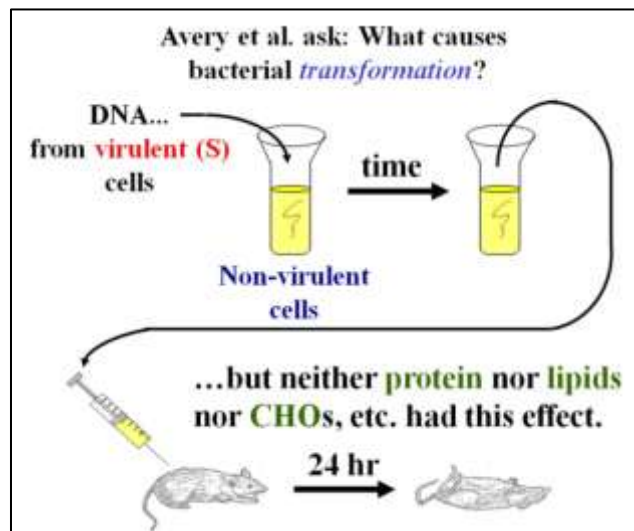

Since only the **DNA fraction** of the dead S cells could cause transformation, Avery et al. concluded that DNA must be the **Transforming Principle**. In spite of the dramatic effect these discoveries were to have eventually, Avery, MacLeod and McCarty did not receive a Nobel Prize... an omission that the Nobel committee eventually admitted!

In spite of the results of Avery et al. many respected scientists still believed that polypeptides (with their seemingly endless combinations of 20 amino acids) had the biological specificity necessary to be genes. While they acknowledged to be a large polymer, they still thought that DNA was that simple molecule, for example a polymer made up of repeating sequences of the 4 nucleotides with a simple base sequence such as ...AGCTAGCTAGCTAGCT..., a sequence without the diversity needed to account for the many proteins that were known to be encoded by genes. To adapt Marshal McLuhan's famous statement that *the medium is the message* (meaning that the airwaves don't merely convey a message), many still believed that proteins are the medium of genetic information *as well as* the functional meaning of the message. Initially held by influential scientists, it is this resistance to accept a DNA *transforming principle* that deprived its discoverers of the Nobel stature it deserved.

Nevertheless, resistance became increasingly untenable as the Avery et al. results were confirmed following the inheritance of other genetic characteristics. It was the key experiment of Alfred Hershey and Martha Chase that put to rest any notion that proteins were genes.

C. Hershey-Chase Experiment

Alfred Hershey and Martha Chase knew the life-cycle of bacterial viruses, called bacteriophage (or phage for short), illustrated below.

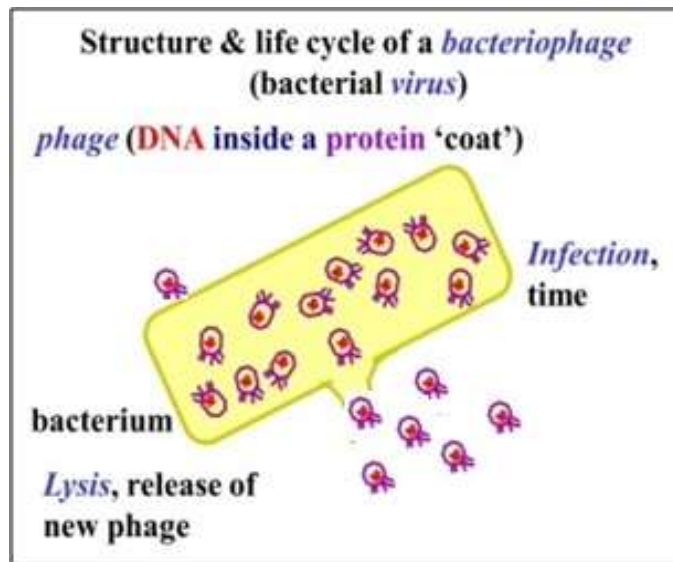

Phages are inert particles until they infect bacterial cells. They start an infection when they bind to the bacterial cell surface. Electron microscope studies revealed the phage particle on the outside of the bacterium. Using a blender (not unlike a kitchen blender),

It was possible to “shake” off the phage particles from the bacterial cells. Centrifugation could then bring the bacterial cells to a pellet at the bottom of the centrifuge tube, leaving the detached ‘phage’ particles in the supernatant above the pellet. If the pelleted cells had been attached to the phage for a short time they would survive and reproduce when re-suspended in growth medium. But if the mixture was incubated long enough (a few hours) before blending and centrifugation, the re-suspended bacterial pellet would go on and lyse, producing new phage. So, it took a few hours for the genetic information in the virus to be transferred to the infected cell. This genetic material was apparently no longer associated with the capsule of the phage particle, which could be recovered from the centrifugal supernatant.

Hershey and Chase wanted to demonstrate that it was the *DNA* enclosed by the viral *protein capsule* that actually caused the phage to infect the bacterium, and not the capsule protein. In the experiment they designed, they separately grew *E. coli* cells infected with *T2* bacteriophage in the presence of either ^{32}P or ^{35}S , radioactive isotopes of phosphorous and sulfur, respectively. The result was to produce phage that contained either radioactive DNA or radioactive proteins, but not both (recall that only DNA contains phosphorous and only proteins contain sulfur). They then separately infected fresh *E. coli* cells with either ^{32}P - or ^{35}S -labeled, radioactive phage. Their experiment is described below.

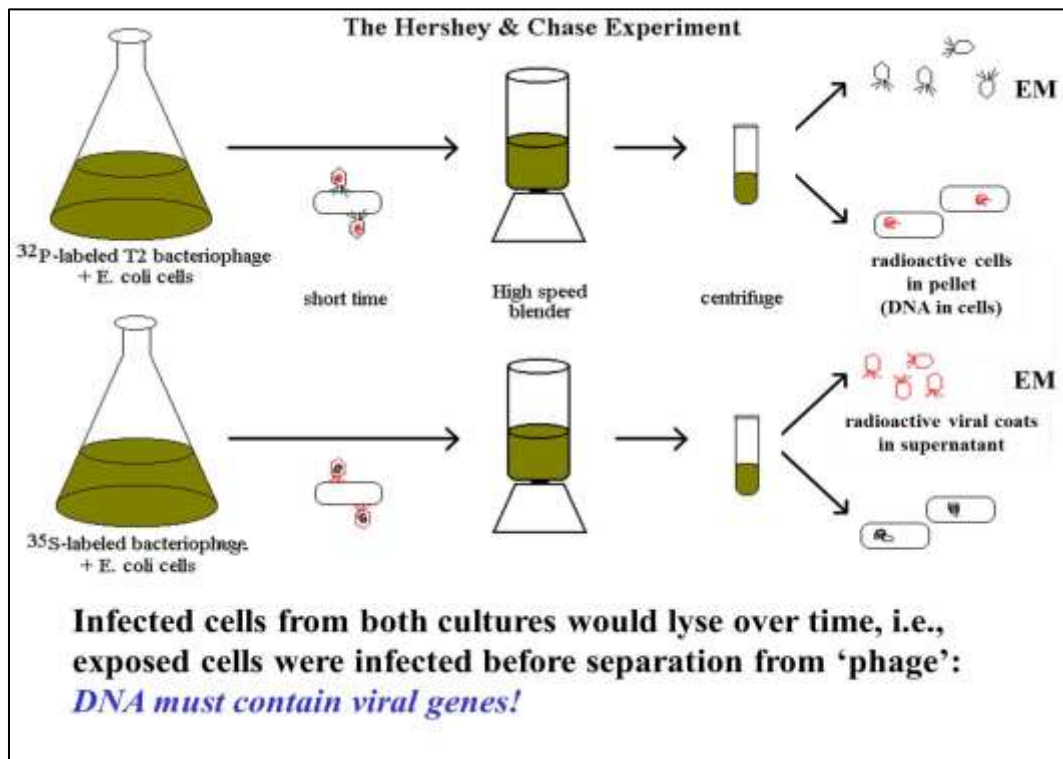

After allowing just enough time for infection after mixing phage with the bacterial cells, some of the cells from each experiment were allowed to go on and lyse to prove that they had become infected. The remainder of each mixture was sent to the blender. After centrifugation of each blend, the pellets and supernatants were examined to see where the radioactive proteins or DNA had gone. From the results, the ^{32}P always ended up in the pellet of bacterial cells while the ^{35}S was found in the phage remnant supernatant. Hershey and Chase concluded that the genetic material of bacterial viruses was DNA and not protein, just as Avery et al. had suggested that DNA was the bacterial transforming principle. But given the earlier resistance to “simple” DNA being the genetic material they used cautious language in framing their conclusions. They needn’t have; all subsequent experiments confirmed that DNA was the genetic material. Concurrent with these confirmations were experiments demonstrating that DNA might not be (indeed, was not) such a simple, uncomplicated molecule! For their final contributions to pinning down DNA as the “stuff of genes”, Alfred D. Hershey shared the 1969 Nobel Prize in Physiology or Medicine with Max Delbruck and Salvador E. Luria.

III. DNA Structure

A. Early Clues and Ongoing Misconceptions

By 1878, a substance in the pus of battle-wounded soldiers derived from cell nuclei (called *nuclein*) was shown to be composed of 5 bases (the familiar ones of DNA and RNA). The four bases known to make up DNA (as part of nucleotides) were thought to be connected through the phosphate groups in short repeating chains of 4 nucleotides. By the time of Avery et al.’s studies, DNA had been shown to be a long polymer, but was still considered to be a simple molecule with a simple nucleotide repeat structure... too simple to account for genes. After the Hershey and Chase experiments, there were only few who did not accept that DNA was the genetic material. The only question was how such a “simple” molecule could account for all the genes in even a simple organism like a bacterium. With the advent of the *X-Ray crystallography*, it became possible to look at the structure of large molecules, including DNA. If a substance can be crystallized, X-rays beamed through the crystal will be bent (*diffracted*) at angles revealing the regular molecular structure of the crystal. William Astbury demonstrated that high molecular weight DNA had just such a regular structure, which he interpreted as a polymer of bases (nucleotides) stacked in a linear structure, each nucleotide separated from the next by 0.34 nm. Astbury is also remembered for describing his use of X-ray crystallography as “*molecular biology*”, the term we use today to cover replication, transcription, translation, gene regulation and all aspects of biomolecular structure.

In a twist of history, the Russian biologist Nikolai Koltsov proposed in 1927 that the basis of genetic transfer of traits would be a "giant hereditary molecule" made up of "two mirror strands that would replicate in a semi-conservative fashion using each strand as a template". A pretty fantastic inference if you think about it, since it was proposed long before before Watson and Crick and their colleagues actually worked out the structure of the DNA double-helix!

B. Wilkins, Franklin, Watson & Crick

Maurice Wilkins was an English biochemist who first isolated highly pure, high molecular weight DNA. Rosalind Franklin was able to crystalize this DNA and generate very high resolution X-Ray diffraction images of the DNA crystals. Franklin's most famous (and definitive) crystallography was "Photo 51", shown below.

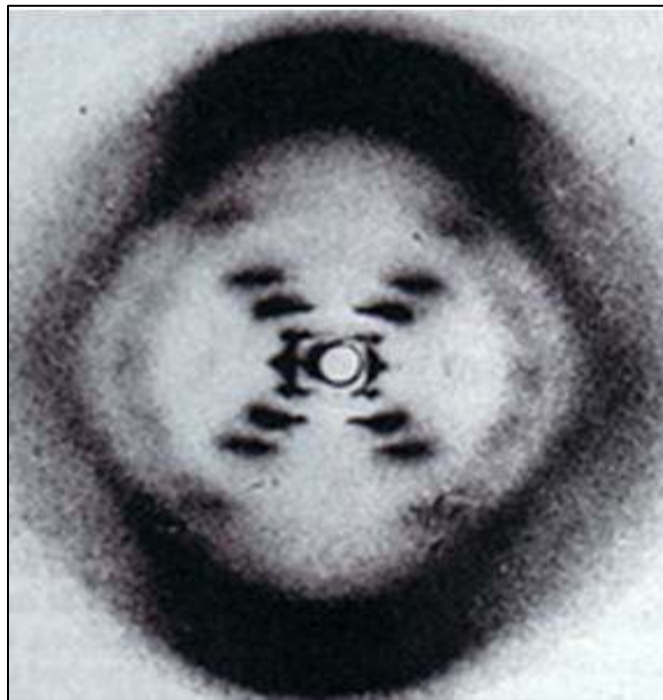

This image confirmed Astbury's **0.34 nm** repeat dimension and revealed two more numbers reflecting repeat structures in the DNA crystal, **3.4 nm** and **2 nm**. When James Watson and Francis Crick got hold of these numbers, they used them as well as other data to build models out of nuts, bolts and plumbing that eventually revealed DNA to be in fact a pair of **antiparallel complementary** nucleic acid (mirror!) strands. Each strand is a string of nucleotides linked by *phosphodiester bonds* and the two strands were held together in a *double helix* by complementary H-bond interactions.

Let's look at the evidence for these conclusions, and as we look at the evidence, refer to the two illustrations of the double helix below.

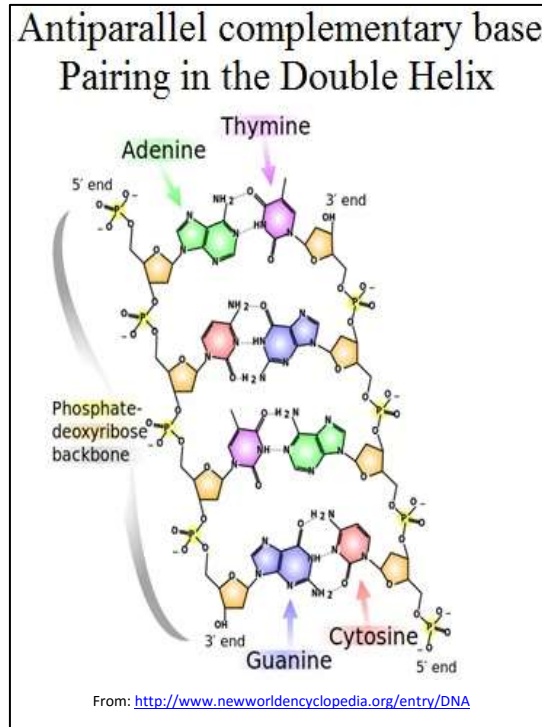
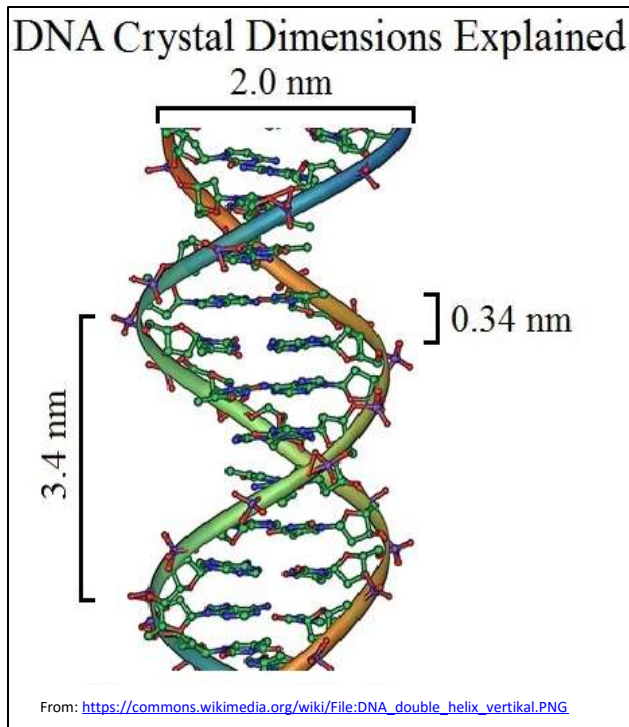

Recalling that Astbury's 0.34 nm dimension was the **distance between successive nucleotides** in a DNA strand, Watson and Crick surmised that the 3.4 nm repeat was a structurally meaningful 10-fold multiple of Astbury's number. When they began building their DNA models, they realized from the bond angles connecting the nucleotides that the strand was forming a helix, from which they concluded that the 3.4 nm repeat was the **pitch** of the helix, i.e., the distance or one complete turn of the helix. This meant that there were 10 bases per turn of the helix. Their scale model supported this conclusion. They further reasoned that the diameter of helix might be reflected in the 2.0 nm number. When their model of a single stranded DNA helix predicted a helical diameter much less than 2.0 nm, they were able to model a **double helix** that more nearly met the 2.0 nm diameter requirement.

In building their double helix, Watson and Crick realized that bases in opposing strands would come together to form H-bonds, holding the helix together. But for their double helix to have a constant diameter of 2.0 nm, they also realized that the smaller **pyrimidine** bases, **Thymine (T)** and **Cytosine (C)**, would have to H-bond to the larger **purine** bases, **Adenine (A)** and **Guanosine (G)**.

Now to the question of how a “simple” DNA molecule could have the structural diversity needed to encode thousands of different polypeptides and proteins... Earlier studies in which *E. coli* DNA was purified, chemically hydrolyzed and shown to contain nearly equal amounts of each base reinforced the notion that DNA was that simple molecule that could not encode genes. But Watson and Crick had private access to some revealing data from Erwin Chargaff’s base composition studies. Chargaff found that the base composition of DNA from different species was not always *equimolar*, that is the DNA was not composed of equal amounts of each of the 4 bases. Some of this data is shown below.

<i>base</i>	<i>human</i>	<i>yeast</i>	<i>fly</i>
purine A	27%	21%	15%
pyrimidine C	23%	32%	35%
purine G	23%	32%	35%
pyrimidine T	27%	21%	15%

The mere fact that DNA from some species could have different base compositions that deviated from an equimolar base composition put to rest the argument that DNA had to be a very simple sequence. Finally it was safe to accept that to accept the obvious, namely that DNA was indeed the “stuff of genes”.

Chargaff’s data also showed a unique pattern of base ratios. Even though base compositions could vary between species, the **A/T** and **G/C** ratio was always 1 for all species. Likewise the ratio of **(A+C)/(G+T)** and **(A+G)/(C+T)** ratios. From this evidence, Watson and Crick inferred that A would H-bond with T and G with C in the double helix. When building their model with this new information, they also found H-bonding between the complementary bases would be maximal only if the two DNA strands were **antiparallel**, leading to the most stable structure of the double helix.

Watson and Crick published their conclusions about the structure of DNA in 1953 (Click here to read their seminal article: [Molecular Structure of Nucleic Acids: A Structure for Deoxyribose Nucleic Acid](#)). Their article is famous for predicting a semiconservative mechanism of replication, something as we’ve seen had been predicted by Koltsov 26 years earlier, albeit based on intuition... and much less evidence!

Watson, Crick and Wilkins shared a Nobel Prize in 1962 for their work on DNA structure. Controversy remains about why Franklin did not receive credit for her role in the work. When she had died in 1958, Nobel prizes were not awarded posthumously but over time, she is getting some long-delayed recognition.

Final confirmation of Watson & crick’s suggestion of semiconservative replication came from Meselson and Stahl’s very elegant experiment, which tested three possible models of replication, shown below.

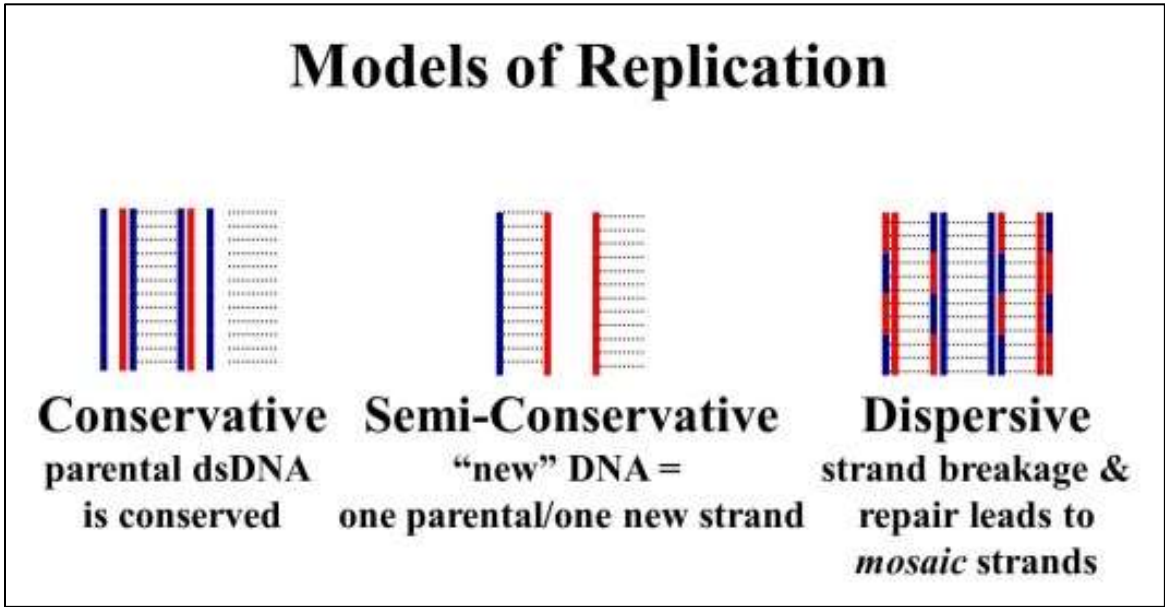

IV. Chromosomes

That chromosomes contained genes was understood from the start of the 20th century. Therefore it becomes necessary to understand the relationship between chromosomes, chromatin, DNA and genes. As noted earlier, chromosomes are really a specialized, *condensed* version of chromatin. The main structural features of a chromosome are shown below.

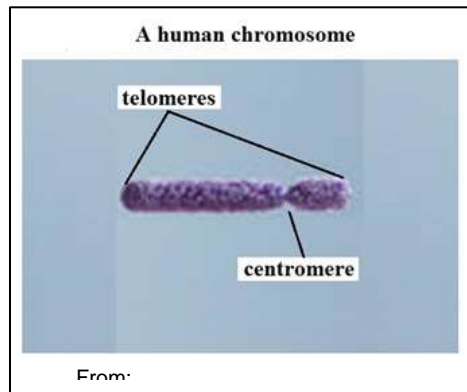

We now know that the compact structure of chromosomes prevents damage to the DNA that might otherwise occur as chromatids are pulled apart by forces on centromeres generated by mitotic or meiotic spindle fibers. Late 19th century observations of chromosome behavior

during cell division pointed to a role in heredity. Chromosomes were seen to condense from the dispersed cytoplasmic background remaining after the nucleus itself breaks down during both mitosis and meiosis. Thus early on, chromosomes were quickly seen as playing a role in heredity. A recent computer-colored cell in mitosis is shown below.

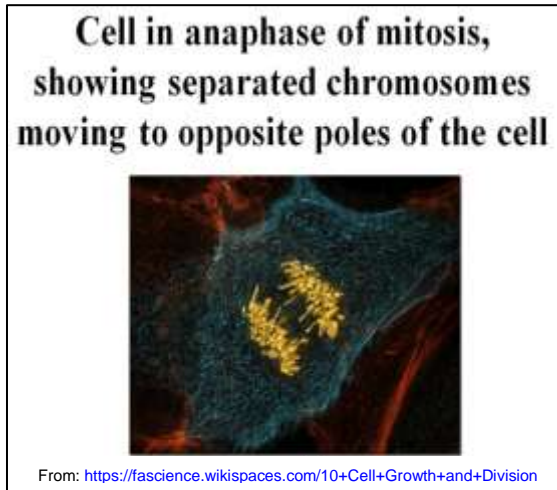

CHALLENGE: Can you explain why virtually all genes in dividing cells are inactive?

When cells in mitosis are placed under pressure, the cells burst and the chromosomes spread apart. Such a chromosome spread is shown below.

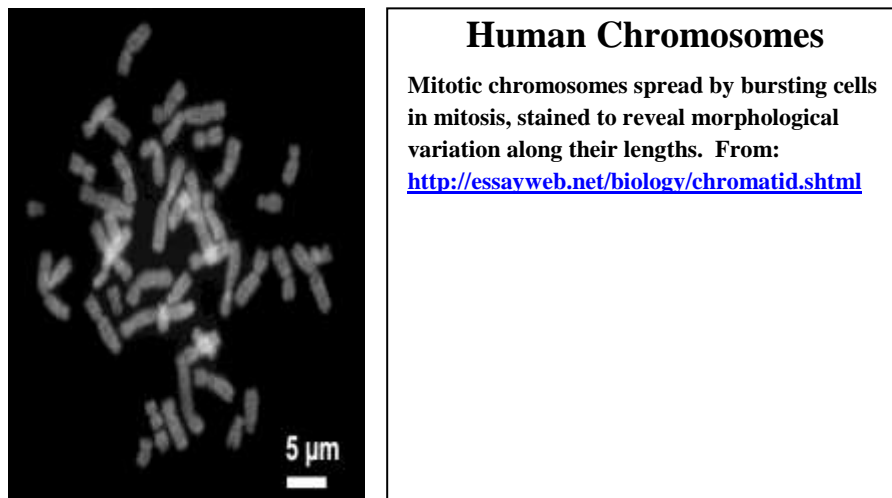

The number, sizes and shapes of chromosomes were shown to be species-specific. Finally, a close look at spreads from different species revealed that chromosomes came in morphologically matched pairs. This was so reminiscent of Gregor Mendel's paired hereditary factors that chromosomes were widely accepted as the structural seat of genetic inheritance. The morphological pairing of chromosomes can readily be seen in a **karyotype**, created by cutting apart a micrograph like the one above with a pair of scissors and matching the chromosomes. The paired homologous chromosomes in the human female karyotype shown below are easily identified.

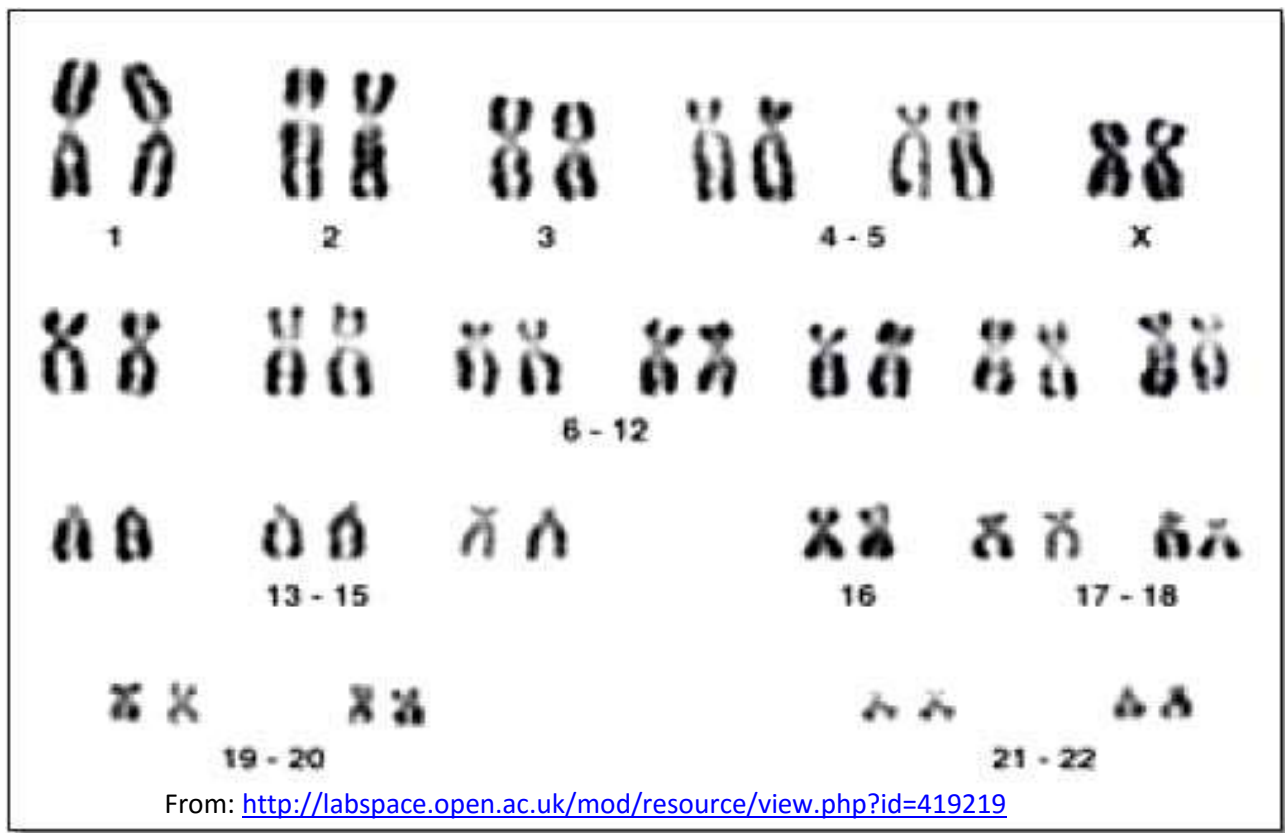

Captured in mitosis, all dividing human cells contain 46 chromosomes that can be karyotyped. In this karyotype, the duplicated chromatids have not yet separated, indicating that the chromosomes were spread from metaphase cells. These chromosomes are from a female cell; note the homologous sex ("X") chromosome pair at the upper right of the karyotype. The X and Y chromosomes of males are aligned when creating a karyotype, but these chromosomes are not truly homologous. Chromosomes in both the original spread and in the aligned karyotype have been stained, revealing morphological markings that help distinguish the chromosomes and their homologs.

V. Genes and Chromatin

Chromosomes and chromatin are a uniquely eukaryotic association of DNA with more or less protein. Bacterial DNA (and prokaryotic DNA generally) is relatively 'naked' – not visibly associated with protein.

CHALLENGE: Why do you think prokaryotic DNA is mostly “naked”?

If chromosomes represent the most condensed form of chromatin, then the electron micrograph of a eukaryotic cell below reveals that interphase cell chromatin can itself exist in various state of condensation.

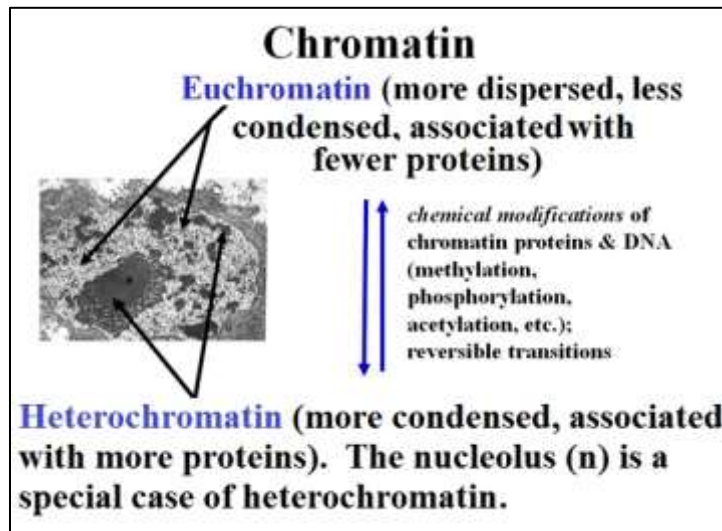

During interphase chromatin can undergo a transition between the more condensed *heterochromatin* and the less condensed *euchromatin*. These transitions involve changes in the amounts and types of proteins bound to the chromatin that can occur as genes are regulated (activated or silenced). Active genes tend to be in the more dispersed in euchromatin so that enzymes of replication and transcription have easier access to the DNA. Genes that are inactive in transcription are heterochromatic, obscured by chromatin proteins present in heterochromatin. We'll be looking at some experiments that demonstrate this in a later chapter.

CHALLENGE: What are some likely effects of chemical modifications of chromatin proteins that could explain their behavior?

In general terms, we can define three levels of chromatin organization:

1. DNA wrapped around histone proteins form *nucleosomes* in a "beads on a string" structure.
2. Multiple nucleosomes coil (condense), forming 30 nm fiber (solenoid) structures.
3. Higher-order DNA packing of the 30 nm fiber leads to formation of metaphase chromosomes seen in mitosis & meiosis.

CHALLENGE: Describe the difference between metaphase and anaphase chromosomes, using appropriate terminology.

The three levels of chromatin structure are illustrated below.

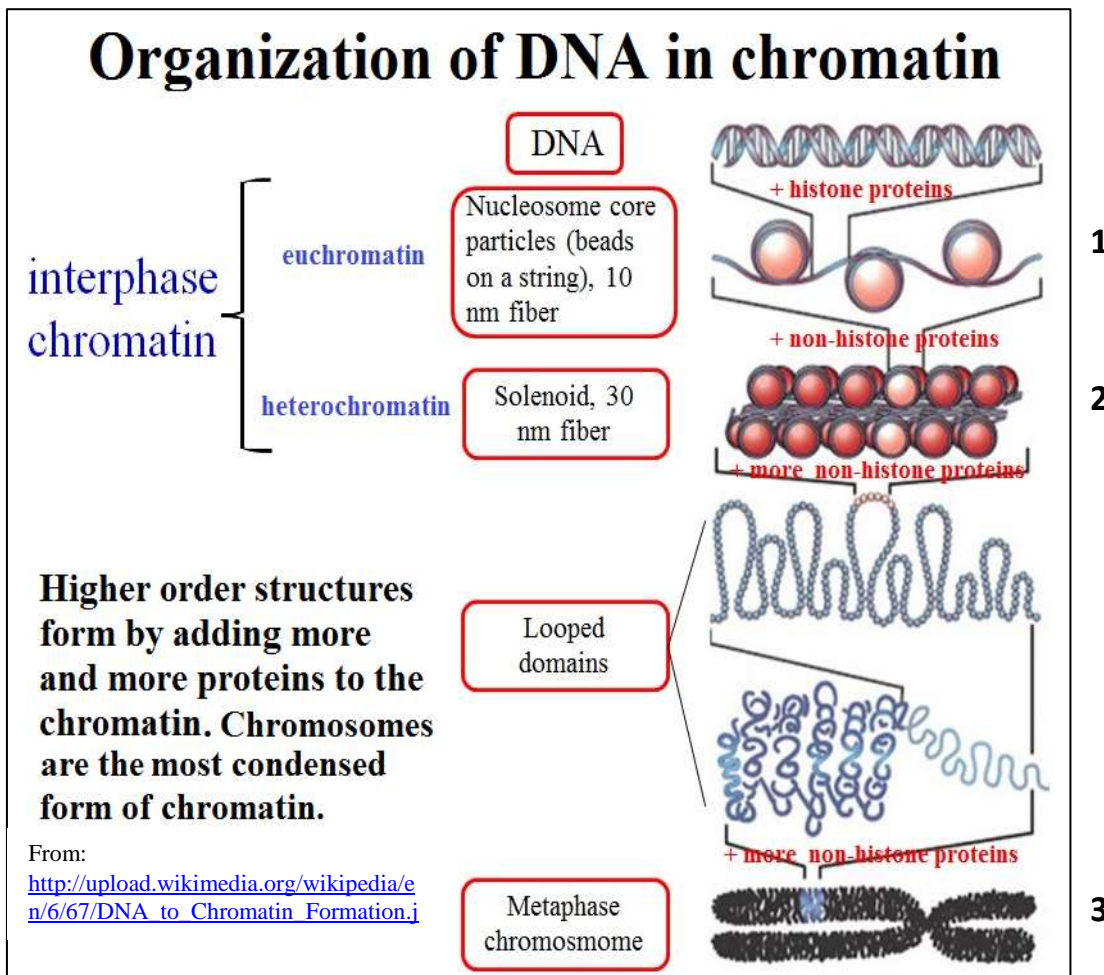

These levels of chromatin structure were determined in part by selective isolation and extraction of interphase cell chromatin. Nuclei are first isolated from the cells and the

nuclear envelope gently ruptured so as not to physically disrupt chromatin structure. At this point the chromatin can be subjected either to a gentle high salt, low salt or acid extraction. Low salt extraction dissociates most of the proteins from the chromatin. The remainder of the chromatin can be pelleted by centrifugation. This material looks like *beads on a string*; the ‘beads’ are called *nucleosomes* (below).

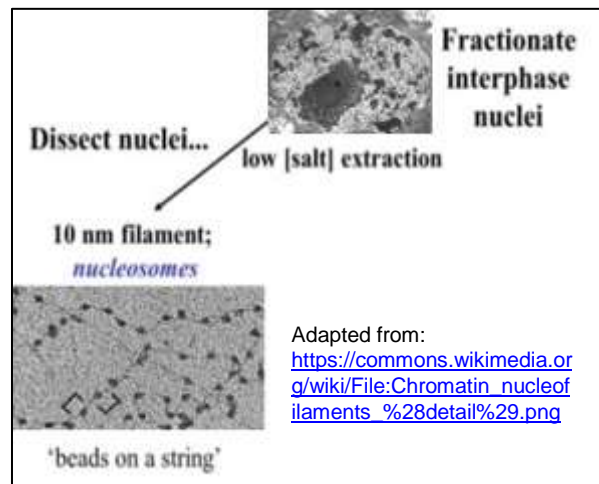

When these nucleosome necklaces were digested with the enzyme *deoxyribonuclease* (**DNase**), the regions of DNA between the ‘beads’ were degraded leaving behind shorter 10nm filaments or just single beads the beads (below).

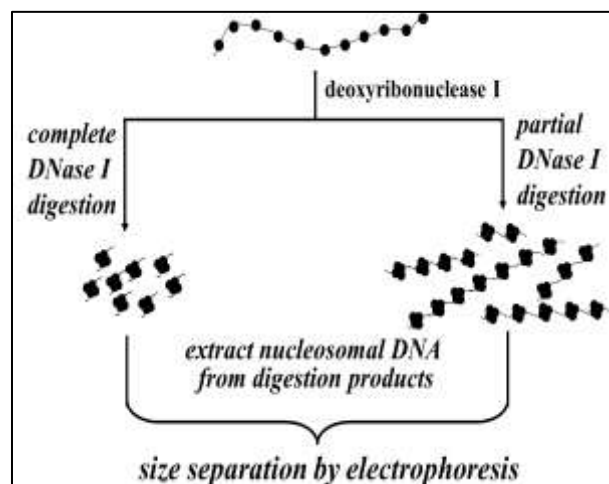

Roger Kornberg (son of Nobel Laureate Arthur Kornberg who discovered the first DNA polymerase enzyme of replication) participated in the discovery and characterization of nucleosomes while a post-doc! Electrophoresis of DNA extracted from these digests revealed that *nucleosomes* were separated by a “linker” DNA stretch of about 80 base pairs, and that the nucleosomes themselves consisted of proteins wrapped by about

147 base pairs of DNA. When the beads were subjected to a protein extraction and the isolated proteins then separated by electrophoresis, 5 proteins were identified (illustrated below).

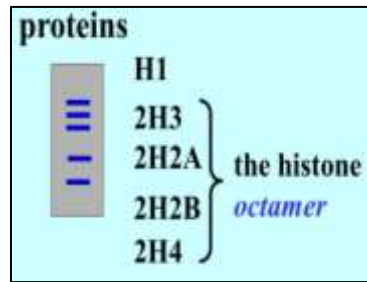

Histones are highly basic proteins containing many *lysine* and *arginine* amino acids, each with a positively charged side chain. This enables them to bind the very acidic, negatively charged *phosphodiester backbone* of the double helical DNA. DNA wraps around an octamer of histones (2 each of 4 of the histone proteins) to form a *nucleosome*. About a gram of histones is associated with each gram of DNA.

CHALLENGE: Histones are among the most highly conserved eukaryotic proteins. Very few amino acid differences distinguish a histone in a human from the homologous histone in a mouse, robin, turtle, sea urchin, or even a yeast cell. Why do you think that is?

If chromatin is subjected to a high salt extraction, the remaining structure visible in the electron microscope is the 30nm solenoid, a coil of nucleosomes that is 30nm in diameter (shown below). Simply increasing the salt concentration of a nucleosome preparation in fact causes the nucleosomes to fold into the 30nm solenoid structure.

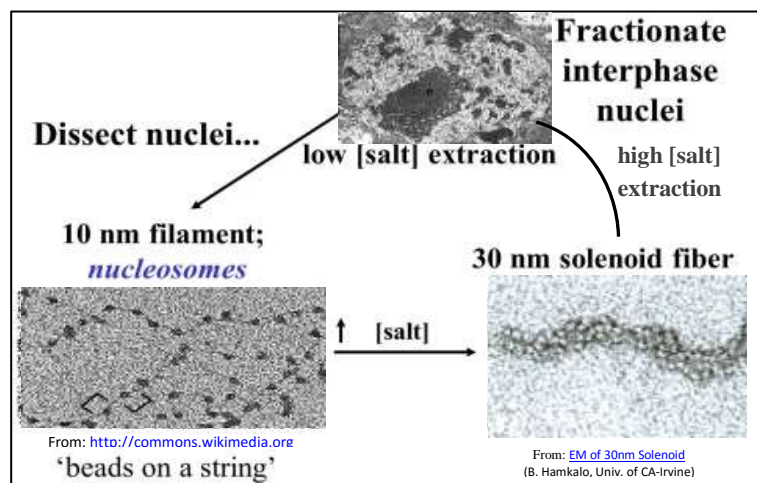

As you might guess, an acidic extraction should selectively remove the basic histone proteins, leaving behind an association of DNA with non-histone proteins. This proved to be the case, and an electron micrograph of the chromatin remnant after an acid extraction of metaphase chromosomes is shown below.

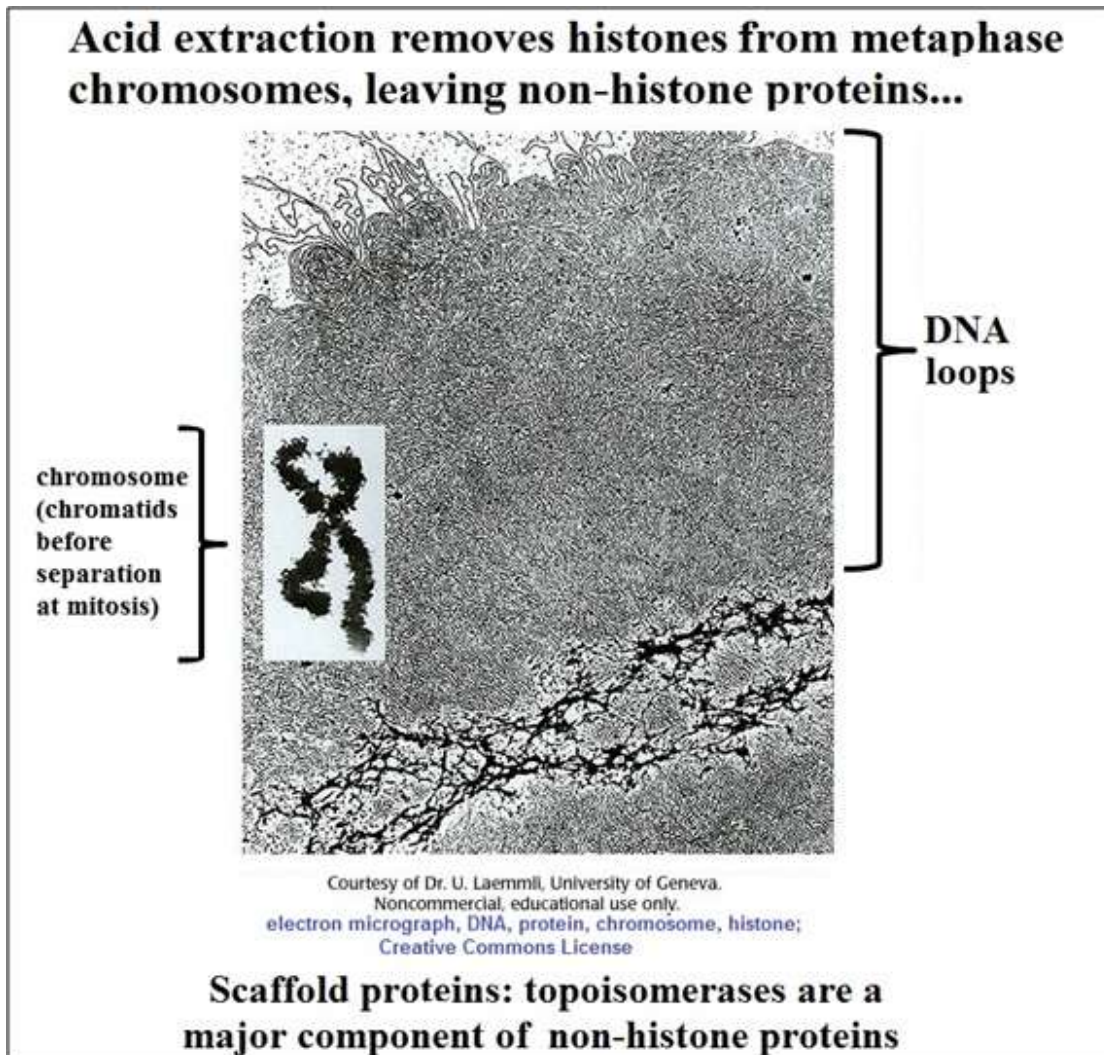

The DNA, freed of the regularly spaced histone based nucleosomes, loops out away from the long axis of the chromatin. The dark material, labeled scaffold protein, makes up most of what is left after removal of the histones, and much of this protein is the enzyme *topoisomerase*. As we will see, topoisomerases prevent DNA from breaking apart under the strain of replication.

And this brings us to replication itself.

VI. DNA Replication

DNA strands have directionality, with a 5' nucleotide-phosphate and a 3' deoxyribose hydroxyl end. Because the strands of the double helix are *antiparallel*, the 5' end of one strand aligns with the 3' end of the other at both ends of the double helix. The complementary pairing of bases in DNA means that the information contained on a single strand could be used as a template to make a new complementary strand. As we'll see, this structure of DNA created some interesting dilemmas for understanding the biochemistry of replication. The puzzlement surrounding how replication proceeds begins with experiments that visualize replicating DNA.

A. Visualizing Replication and Replication Forks

Geneticists had already determined that bacterial chromosomes were circular before John Cairns confirmed this fact by direct visualization. He grew *E. coli* cells for long periods on ^3H -thymidine ($^3\text{H-T}$) to make all of their DNA radioactive. He then treated the cells to gently break them open and release their DNA. The DNA was allowed to settle on membranes to which the DNA adhered. A radiation sensitive film was layered onto the membrane to allow the radiation to expose the film, creating an autoradiograph that which was then examined in the electron microscope.

Cairns saw tracks of silver grains in the exposed film of his autoradiographs (the same kind of silver grains that create an image on film in old-fashioned photography). A sampling of his autoradiographic images is illustrated below.

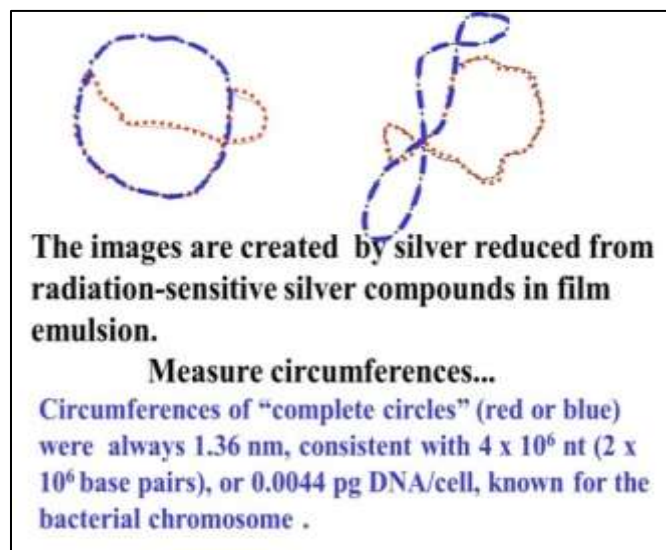

Cairns measured the length of the “silver” tracks, which usually consisted of three possible closed loops, or circles. Two of these circles were always equal in length, with a circumference that was virtually predicted by the DNA content of a single, non-dividing cell. Cairns therefore interpreted these images to be bacterial DNA in the process of replicating, and arranged a sequence of images of disparate autoradiographs to make his point (illustrated below).

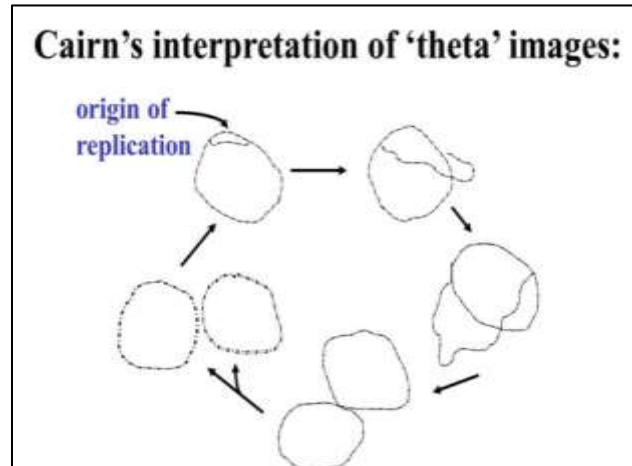

Because the replicating chromosomes looked (rather vaguely!) like the Greek letter θ , he called them **theta images**. Cairns inferred that replication started at a single point on the bacterial chromosome, the **origin of replication**. Subsequent experiments demonstrated that replication did indeed begin at an origin of replication, after which the double helix was unwound and replicated away from the origin in both directions, forming two **replication forks**, (illustrated below).

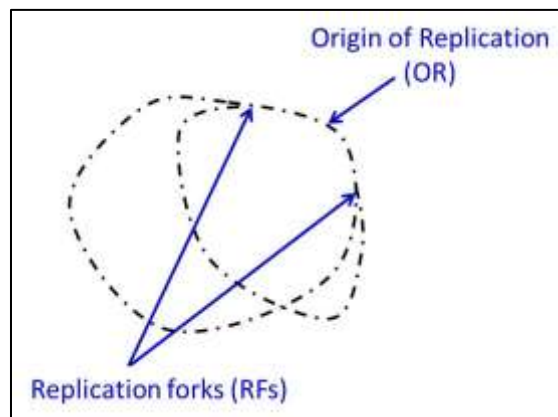

Click http://youtu.be/p_c7VJvqEbo to see David Prescott's the elegant experiments demonstrating *bi-directional replication* from two replication forks.

Bacterial cells can divide every hour or even less, meaning that the rate of bacterial DNA synthesis is about 2×10^6 base pairs per hour. A nucleus of a typical eukaryotic cell contains thousands of times as much DNA in their nucleus compared to bacteria, and even a small chromosome can contain hundreds or thousands of times as much DNA as a bacterium. Thus eukaryotic cells cannot afford to double their DNA at a bacterial rate of replication! This problem was solved *not* by evolving a faster biochemistry of replication, but by evolving multiple origins of replication from which DNA synthesis proceeds in both directions, creating **replicons** that eventually meet to complete replication of linear chromosomes.

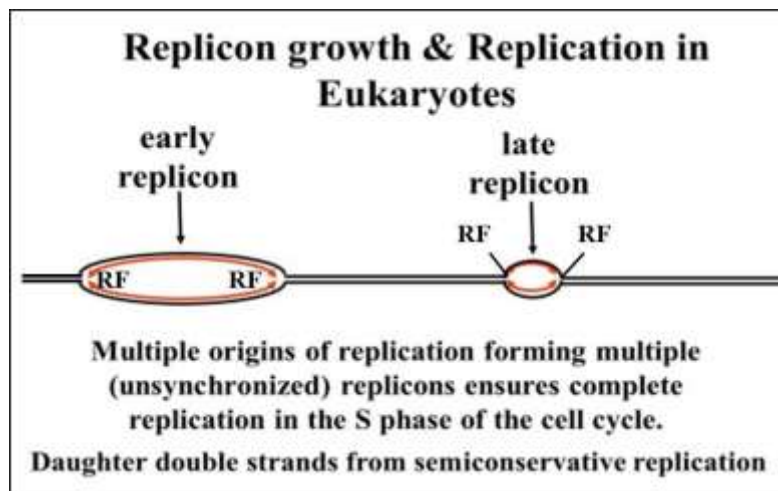

Before we consider the biochemical events of replication at replication forks in detail, let's look at the role of DNA polymerase enzymes in the process.

B. DNA Polymerases Catalyze Replication

The first of these enzymes was discovered in *E. coli* by Arthur Kornberg, for which he received the 1959 Nobel Prize in Chemistry. Two more were later found by one of Arthur's sons, Thomas! All DNA polymerases require a template strand against which to synthesize a new complementary strand. And all grow new DNA by adding to the 3' end of the growing DNA chain in successive condensation reactions. All DNA polymerases also have the odd property that they can only add to a pre-existing strand of nucleic acid, raising the question of where the 'pre-existing' strand comes from! The reaction catalyzed by DNA polymerases forms a phosphodiester linkage between the end of a growing strand and the incoming nucleotide complementary to the template strand. The energy for the formation of the phosphodiester linkage comes in part from the hydrolysis of two phosphates (*pyrophosphate*) from the incoming nucleotide during the reaction.

Replication requires the participation of many nuclear proteins in both prokaryotes and eukaryotes. But all of the basic steps of replication are performed by the DNA polymerase enzyme itself, as shown in the illustration below.

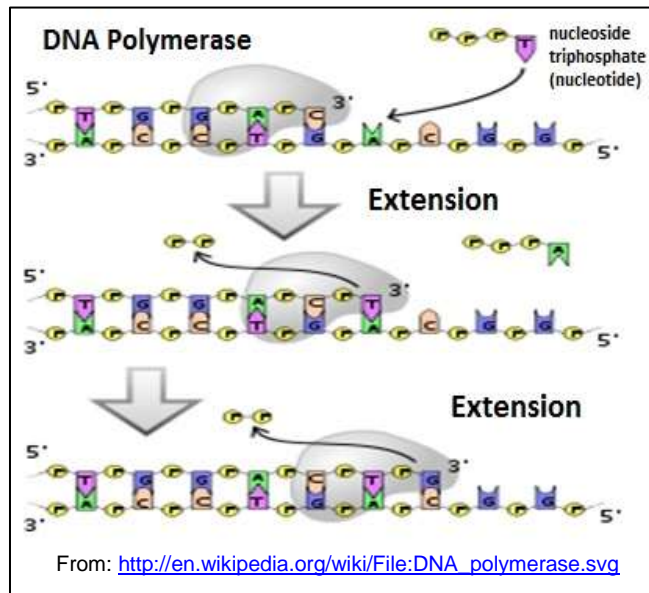

DNA polymerases replicate DNA with high fidelity, with as few as one error per 10^7 nucleotides. But mistakes do occur. Thanks to the proofreading ability of some DNA polymerases, mistakes are most often corrected. The polymerase can sense a mismatched base pair, slow down and then catalyze repeated hydrolyses of nucleotides until it reaches the mismatched base pair (shown below).

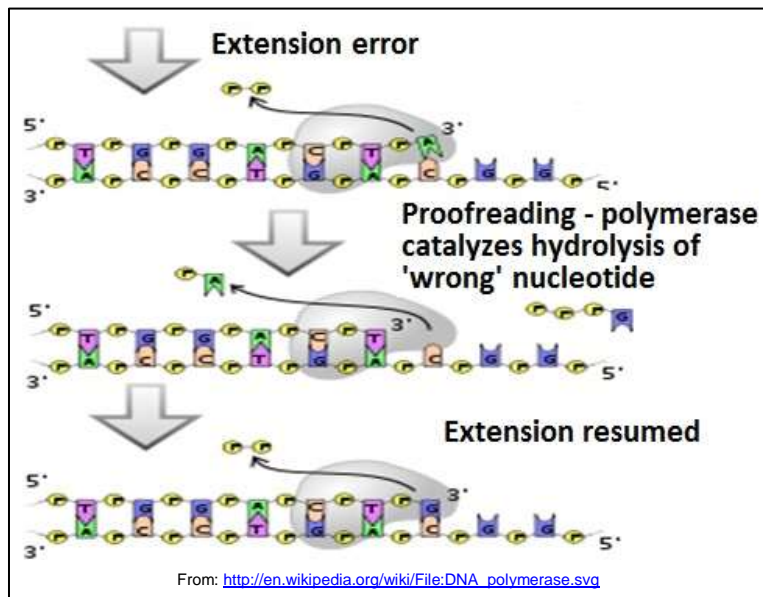

After mismatch repair, the DNA polymerase resumes forward movement once again. Of course not all mistakes are caught by this or other corrective mechanisms (see *DNA Repair*, below). In eukaryotic organisms, mutations in the germ line cells that elude these corrections can cause genetic diseases. But most often, they are the mutations that fuel evolution.

CHALLENGE: In classical genetic terms, mutation in a gene that produces an inactive enzyme is recessive, In old fashioned Mendelian genetic terms, what would the genotype and phenotype be of the progeny of a cross between a male and a female that are both heterozygous for the gene for this enzyme?

Without mutations in germ line cells (egg and sperm), there would be no mutations and no evolution, and without evolution, life itself would have reached a quick dead end! Other replication mistakes can generate mutations somatic cells. If these somatic mutations escape correction they can have serious consequences, including the generation of tumors and cancers.

C. The Process of Replication

DNA replication is a sequence of repeated condensation (dehydration synthesis) reactions linking nucleotide monomers into a DNA polymer. Like all biological polymerization processes, replication proceeds in three enzymatically catalyzed and coordinated steps: **initiation**, **elongation** and **termination**.

1. Initiation

As we have seen, DNA synthesis starts at one or more origins of replication. These are DNA sequences targeted by *initiator proteins* in *E. coli* (see illustration below and/or the animation at <http://youtu.be/29gFdfhtmYk>).

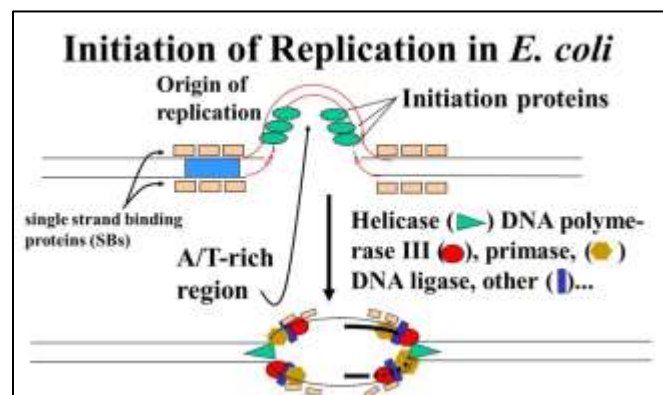

After breaking hydrogen bonds at the origin of replication, other factors progressively unzip the double helix in both directions, using the separated DNA strands as templates for new DNA synthesis.

Sequences that bind to initiation proteins tend to be rich in adenine and thymine bases. This is because A-T base pairs have two hydrogen bonds that require less energy to break than the three hydrogen bonds holding G-C pairs together. Once the hydrogen bonds at the origin of replication have been loosened, *DNA helicase*, *DNA primase*, *DNA polymerase III* and other proteins are recruited to the site. Helicase uses energy from ATP to unwind the double helix and DNA polymerase III is the main enzyme that elongates new DNA. At this point, two replication forks have formed on either side of a *replication bubble* (nascent replicon), and replication can begin with repeated cycles of elongation.

All DNA replication requires the free 3' hydroxyl group of a pre-existing nucleic acid strand to which the DNA polymerase will add additional nucleotides.

CHALLENGE: Why do you think that the evolution of DNA replication resulted in DNA strand elongation only by addition to the 3'-end of each strand?

Since no known DNA polymerase can start synthesizing new DNA strands from scratch, this is a problem! The action of DNA polymerases must require a *primer*, a strand to which new nucleotides can be added. And indeed, these primers exist. The question is, where does the primer come from?

On the other hand, *RNA polymerases* (enzymes that catalyze RNA synthesis) *can* synthesize a new nucleic acid strand from scratch (i.e., from the first base). Therefore, it was suggested that a short RNA primer would be made, to which new deoxynucleotides would be added by DNA polymerase. The use of RNA primers was confirmed when short stretches of RNA were found at the 5' ends of Okazaki fragments! Cells use a *primase* (a specialized RNA polymerase that is active during replication) to synthesize the short RNA primer required for elongation by DNA polymerase (see below).

2. Elongation

If we look at elongation at one replication fork (below), we can see another problem:

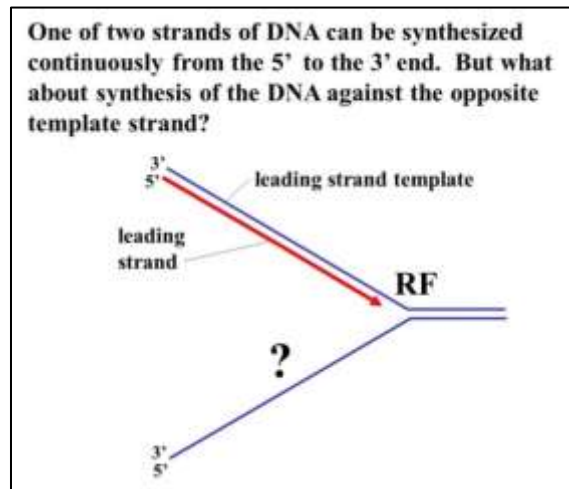

One of the two new DNA strands can grow continuously towards the replication fork as the double helix unwinds. But what about the other strand? Either the other strand must either grow in pieces in the opposite direction, or must wait to begin synthesis until the double helix is fully unwound.

When mutants of T4 phage that grew slowly in their *E. coli* host cells were isolated, Okazaki and Okazaki showed that the cause was a mutation in the gene for the enzyme called DNA ligase. This enzyme was required to “stitch together” the ends of linear phage DNA to generate its circular “chromosome”. The data on T4 phage growth of wild type and mutant T4 phage is summarized below.

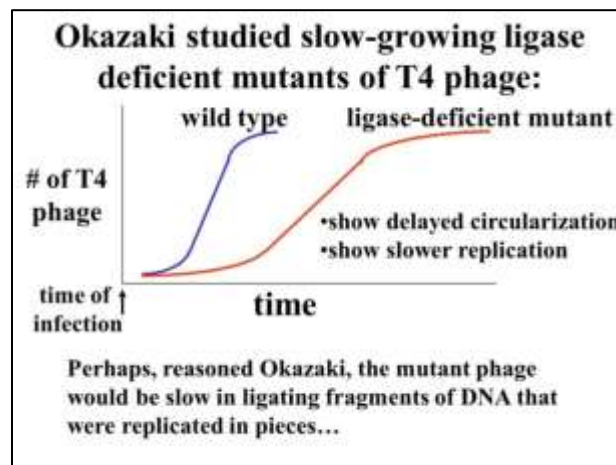

This suggested the hypothesis that DNA ligase plays a role in the discontinuous synthesis of DNA. The hypothesis was that DNA replicated against the lagging strand template was synthesized in fragments that were then linked in a dehydration synthesis reaction by DNA ligase to form phosphodiester linkages between DNA fragments, as illustrated below.

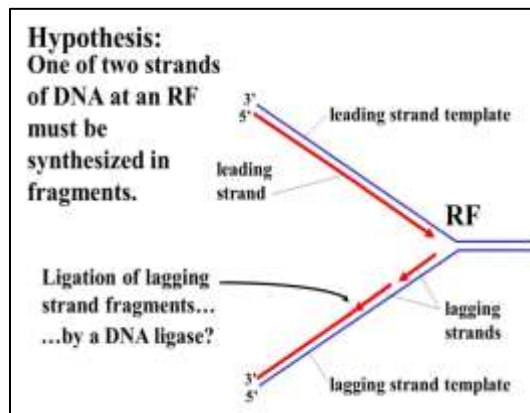

When the hypothesis was tested, the Okazaki found that short DNA fragments did indeed accumulate in *E. coli* cells infected with ligase-deficient mutants, but not in cells infected with wild type phage. The lagging strand fragments are called **Okazaki fragments** after their discoverers.

But this scenario creates another dilemma! Each Okazaki fragment would have to begin with a 5' RNA primer. This primer would have to be removed and replaced with DNA nucleotides before the fragments were stitched together by DNA ligase. This in fact happens, and the process illustrated below.

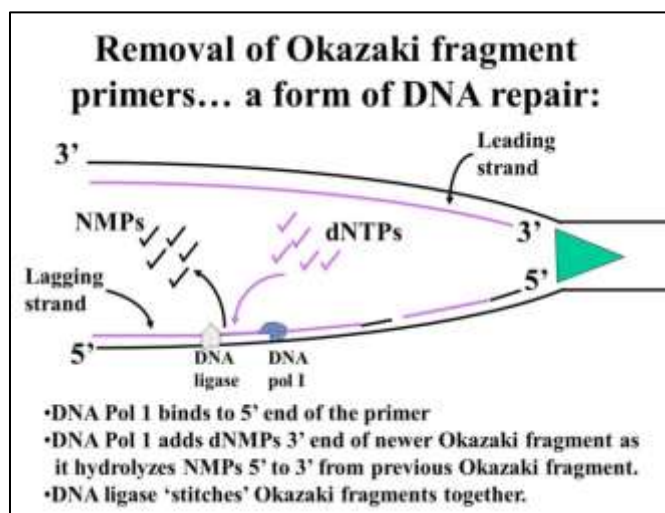

Removal of the RNA primer nucleotides from Okazaki fragments requires the action of **DNA polymerase I**, that can catalyze hydrolysis of phosphodiester bonds between the RNA (or DNA) nucleotides from the 5'-end of a nucleic acid strand. *Flap Endonuclease 1 (FEN 1)* also plays a role in removing 'flaps' of nucleic acid from the 5' ends of the fragments often displaced by polymerase as it replaces the replication primer. At the same time that the RNA nucleotides are removed, DNA polymerase I catalyzes their replacement by the appropriate deoxy-nucleotides. Finally, when each fragment is entirely DNA, *DNA ligase* links it to the rest of the discontinuously-growing DNA strand. Because of its 5' *exonuclease* activity (not found in other DNA polymerases), DNA polymerase I also plays unique roles in DNA repair.

As Cairn's suggested and others demonstrated, replication proceeds in two directions from the origin to form the replication bubble, or replicon with its two replication forks (RFs). Each RF has a primase associated with replication of Okazaki fragments along lagging strand templates, as shown below.

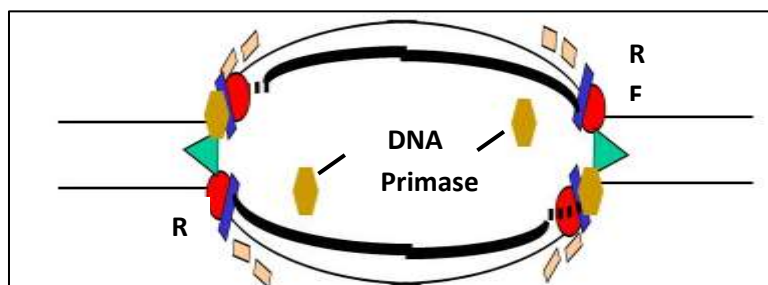

We'll look at how all of these replication activities might be coordinated after considering what happens when replicons reach the ends of the linear chromosomes of eukaryotes.

3. Termination

In prokaryotes, replication is complete when the two replication forks meet after replicating their portion of the circular DNA molecule. In eukaryotes, the many replicons fuse to become larger replicons, eventually reaching the ends of the chromosomes. At that point, replication of linear DNA undergoes a *termination* process involving extending the length of one of the two strands by the enzyme *telomerase* and replicating the extended DNA using DNA polymerase. This complex set of reactions evolved in eukaryotes because without it, chromosomal DNA would be shortened after each round of replication. In 2009 Elizabeth Blackburn and Carol Greider shared the 2009 Nobel Prize in Physiology or Medicine, for discovering telomerase. Blackburn is now President of the Salk Institute in California.

One of the more interesting recent observations was that differentiated, non-dividing cells no longer produce the telomerase enzyme. On the other hand, the telomerase gene is active in normal dividing cells (e.g., stem cells) and cancer cells, which contain abundant telomerase.

CHALLENGE: Why the difference in telomerase activities here!?

The action of telomerase is summarized in the illustration below, and animated at <http://youtu.be/xdm4UpixaLU>.

Telomerase (a ribonucleoprotein (RNP))



telomerase

UCUA
CUUAC

CAACCCCAACCC

GTTGGGGTTGGGGTTGGGGTTGGGGTTG-3'

1. primer removal (DNA Pol 1)
2. binding of telomerase
3. extension of template strand by telomerase: synthesis of telomere repeat sequences
4. telomerase shifts to right
5. more extension of (3' end of) template strand by telomerase
6. Priming, synthesis and ligation of 'extra' Okazaki fragment from extended template strand...

4. Replication is *Processive*

The drawing of the replicon above suggests separate events on each DNA strand, but we now know that replication is **processive**, meaning that both new DNA strands are made in the same direction at the same time. How is this possible?

In the illustration below, the lagging strand template DNA is shown bending around so that it faces in the same direction as the leading strand at the replication fork.

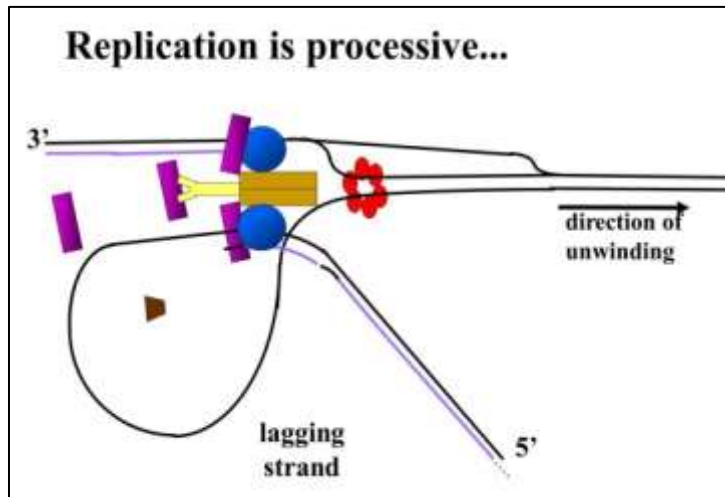

The structure cartooned at the replication fork is called a **replisome**, and consists of *clamp proteins*, primase, helicase, DNA polymerase, among other proteins. Processive replication is animated at <http://youtu.be/ThMSjtgqNDo>.

5. Yet Another problem with replication

Cairns recorded many images of *E. coli* below.

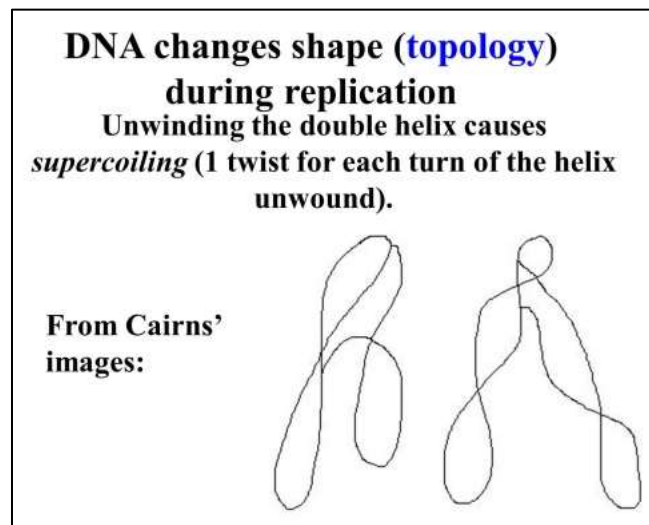

The coiled, or twisted appearance of the replicating circles were interpreted to be a natural consequence of trying to pull apart helically intertwined strands of DNA... or in fact, intertwined strands of any material! As the strands continued to unwind, it was reasoned that the DNA would twist into a kind of *supercoiled DNA*, and that increased DNA unwinding would cause the phosphodiester bonds in the DNA to rupture, fragmenting the DNA. Since this does not happen, experiments to demonstrate the supercoiling phenomenon were devised, and hypotheses for mechanism to *relax* the supercoils were suggested. Testing these hypotheses revealed enzymes called topoisomerases which catalyze hydrolysis of phosphodiester bonds, controlled unwinding of the double helix, and re-formation of the phosphodiester linkages. It is important to note that the topoisomerases are not part of a replisome, but can act far from a replication fork, probably responding to the tensions in overwound DNA. Recall that the topoisomerases comprise much of the protein lying along eukaryotic chromatin.

We have considered most of the molecular players in replication. Below is a list of the key replication proteins and their functions (from [DNA Replication in Wikipedia](#)):

Enzyme	Function in DNA replication
DNA Helicase	Also known as helix destabilizing enzyme. Unwinds the DNA double helix at the Replication Fork .
DNA Polymerase	Builds a new duplex DNA strand by adding nucleotides in the 5' to 3' direction. Also performs proof-reading and error correction.
DNA clamp	A protein which prevents DNA polymerase III from dissociating from the DNA parent strand.
Single-Strand Binding (SSB) Proteins	Bind to ssDNA and prevent the DNA double helix from re-annealing after DNA helicase unwinds it thus maintaining the strand separation.
Topoisomerase	Relaxes the DNA from its super-coiled nature.
DNA Gyrase	Relieves strain of unwinding by DNA helicase; this is a specific type of topoisomerase
DNA Ligase	Re-anneals the semi-conservative strands and joins Okazaki Fragments of the lagging strand.
Primase	Provides a starting point of RNA (or DNA) for DNA polymerase to begin synthesis of the new DNA strand.
Telomerase	Lengthens telomeric DNA by adding repetitive nucleotide sequences to the ends of eukaryotic chromosomes .

VII. DNA Repair

A. DNA Damage (Mutation) is a Fact of Life

We generally accept the notion that replication faithfully duplicates the genetic material. But as we have seen, evolution would not be possible without mutation, and mutation is not possible without at least some adverse consequences.

Germline mutations are heritable. When present in both alleles of a gene, they can result in genetic disease (e.g., Tay-Sach's disease, cystic fibrosis, hemophilia, sickle-cell anemia, etc.). Rather than causing disease, some germline mutations may increase the likelihood of becoming ill (e.g., mutations of the *BRCA2* gene greatly increase a woman's odds of getting breast cancer). **Somatic mutations** in cells that can divide can result in benign and malignant tumors (i.e., "cysts" or cancer), among other conditions. Other somatic mutations may play a role in dementia (Alzheimer's disease) or neuropathologies along the autism spectrum.

As you might imagine, the complex chemistry of replication is prone to an inherently high rate of error. To survive an otherwise high rate of mutation, cells have evolved systems of DNA repair. DNA polymerases themselves have proofreading ability so that incorrectly inserted bases can be removed and replaced. But beyond this, multiple mechanisms have evolved to repair mismatched base pairs and other kinds of damaged DNA. How often and where DNA damage occurs is random. Which damage will be repaired and which will escape to become a mutation is also random. For those suffering the awful consequences of unrepaired mutation, the balance between retained and repaired DNA damage is to say the least, imperfect. But evolution and the continuance of life itself relies on this balance.

B. What Causes DNA Damage

It is during replication (especially in eukaryotes) that DNA is most exposed and therefore most vulnerable to damage. And as we have just seen, replication is just such a complex process, involving many proteins and enzymatic activities acting on DNA in a sea of nucleotide phosphate precursors. The simplest damage to DNA during replication is the point mutation, or base substitution. This can occur when a 'wrong' nucleotide is accidentally incorporated into a growing DNA strand. Other mutations, equally accidental, include DNA deletions, duplications, inversions, etc., any of which might escape repair. The causes of DNA damage include spontaneous intracellular events (e.g., oxidative reactions) and environmental factors (radiation, exogenous chemicals, etc.).

Based on studies of different kinds of DNA damage, Thomas Lindahl estimated that DNA damaging events might be occurring at the rate of 10,000 per day! Lindahl realized that there must be some “fundamental DNA repair mechanisms” at work to protect cells against such a high rate of DNA damage. The discovery of the **base excision repair** mechanism earned Thomas Lindahl a share in the 2015 Nobel Prize in Chemistry.

Environmental factors that can damage DNA include UV light, X-rays and other radiation) and chemicals (e.g., toxins, carcinogens, and even drugs...). Germline as well as somatic cells can be affected. While mutations can and do cause often debilitating diseases, it's instructive to keep the impact of mutations in perspective. In actuality, most mutations are *silent*; they don't cause disease. And much DNA damage is in fact repaired. More than 99.9% of mistaken base changes are corrected before they have a chance to become mutations. Let's look at some common types of DNA damage that are usually repaired:

- **pyrimidine dimers**, typically of adjacent thymines (less often cytosines) in a DNA strand, caused by UV exposure
- **Depurination**; the *hydrolytic* removal of guanine or adenine from the #1 C (carbon) of deoxyribose in a DNA strand
- **Deamination**: hydrolytic removal of amino (-NH₂) groups from guanine (most common), cytosine or adenine
- **Oxidative damage** of deoxyribose with any base, but most commonly purines
- Inappropriate **methylation** of any bases, but most commonly purines
- **DNA strand breakage** during replication or as a result of radiation or chemical exposure

C. Some Molecular Consequences of Uncorrected DNA Damage

While bacteria suffer DNA damage, we'll focus here on eukaryotes since they have evolved the most sophisticated mechanisms. Remember that unrepaired DNA damage **will** be passed on to daughter cells in mitosis, or **might** be passed on the next generation if the mutation occurs in meiosis in a germline cell.

CHALLENGE: Why do I say “might” here?

Consider the following examples of *molecular consequences* of uncorrected DNA damage.

1. Depurination

This is the spontaneous *hydrolytic* removal of guanine or adenine from deoxyribose C#1 in a DNA strand. Its frequency of 5000 depurinations per cell per day emphasizes the high rate of DNA damage that demands a fix! If not repaired, depurination results in a single base-pair deletion in one chromosome after replication, leaving the DNA in the same region of the other chromosome unchanged (illustrated below).

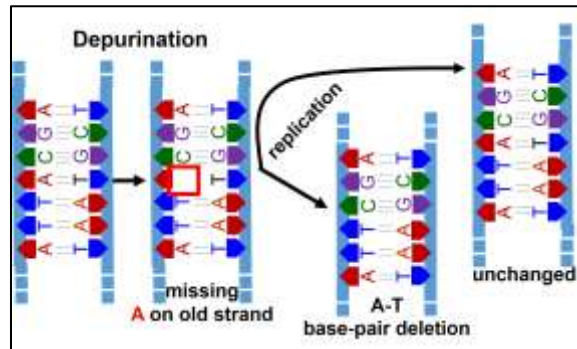

During replication of the depurinated DNA region, the replisome ignores the missing base (an A in this example) and jumps over to the C in the depurinated template DNA. If not repaired, the result paired is one mutated and one unchanged double helix.

2. Pyrimidine Dimerization

Exposure of DNA to UV radiation can cause adjacent pyrimidines (commonly thymines; less often, cytosines) on a strand of DNA form a dimer. Overall, pyrimidine dimers form at a rate of somewhat less than 100 per cell per day! If uncorrected during replication, one chromosome will have a 2-base deletion and the other will be unchanged (illustrated below).

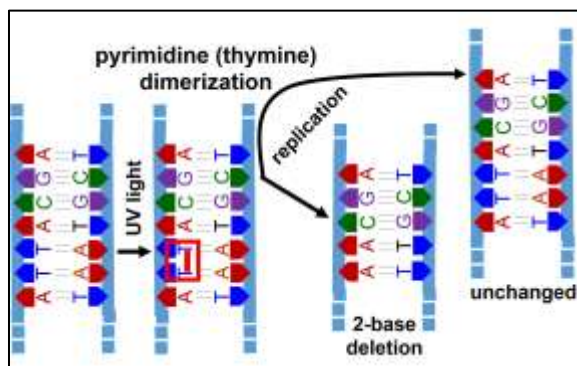

You can predict that correction of this radiation-induced damage will either involve disrupting the dimers (in this case thymine dimers), or removal and replacement of the dimerized bases by monomeric bases.

3. Deamination

Deamination is hydrolytic removal of amino (-NH₂) groups from guanine (most common), cytosine or adenine, at a rate of 100 per cell per day. Deamination does not affect thymine (because it has no -NH₂ groups!). If uncorrected, deamination results in a *base substitution* on one chromosome (actually, a T-A pair substitution for the original C-G in this example) and no change on the other (shown below).

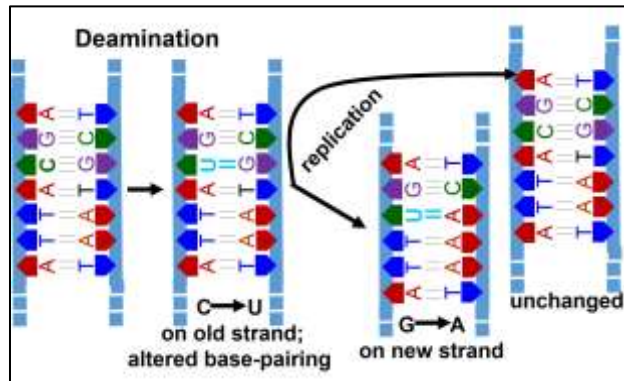

Deamination of adenine or guanine results in unnatural bases (hypoxanthine and xanthine, respectively) which are easily recognized by DNA repair systems and therefore corrected. The U-A base pair is occasionally not repaired.

D. DNA Repair Mechanisms

Many enzymes and proteins have been shown to be involved in DNA repair. It should not be surprising to learn that some of these function in normal replication, mitotic and meiotic events, and were co-opted in DNA repair activities. These molecular co-optations are so vital to normal cell function that some repair activities and molecular players are highly conserved in evolution. Among different DNA repair pathways that have been identified, we will look at **Base Excision Repair**, **Nucleotide Excision Repair**, **Transcription Coupled Repair**, **Non-homologous End-Joining**, and **Homologous Recombination** (of these, the last is perhaps the most complex).

1. Base Excision Repair

Upon detection and recognition of an incorrect base (e.g., oxidized bases, open-ringed bases, deaminated Cs or As, bases where C=C [double] bonds were saturated to C-C bonds...), specific **DNA glycosylases** catalyze hydrolysis of the damaged base from affected deoxyribose in the DNA. To learn more about the specific versions of this enzyme, click https://en.wikipedia.org/wiki/DNA_glycosylase.

An **AP endonuclease** recognizes and hydrolyses the DNA at the nucleotide now missing a base. **Phosphodiesterase** next hydrolyzes the remaining 'base-less' sugar phosphate from the DNA strand. **DNA polymerase** then adds correct missing base to the 3' end of the nick. Finally, **DNA ligase III** (an ATP-dependent mammalian version of the original prokaryotic enzyme) seals the remaining nick in the strand. Most of these enzymes were discovered by Thomas Lindahl (see above). These events of **base excision repair** are summarized below.

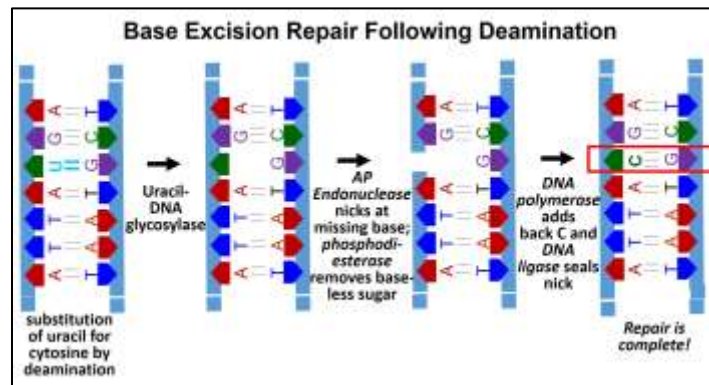

2. Nucleotide Excision Repair

The events of **nucleotide excision repair** are shown below for a pyrimidine dimer.

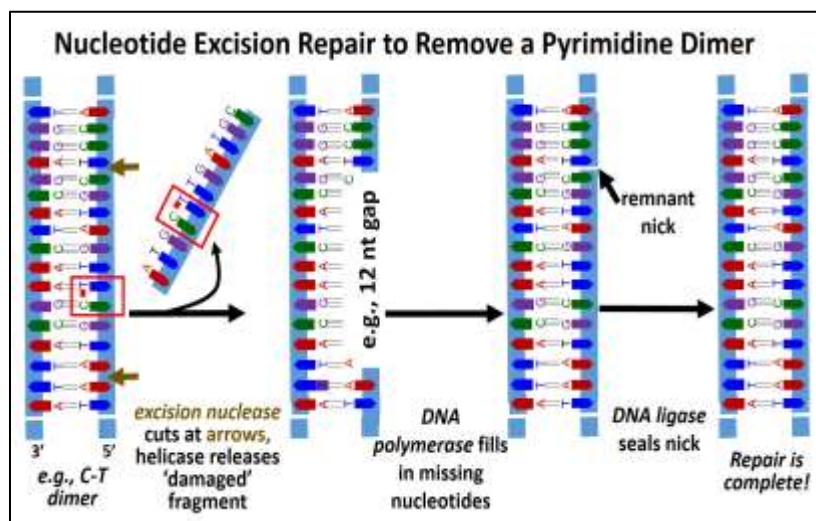

The discovery of the **nucleotide excision repair** mechanism earned Aziz Sancar a share in the 2015 Nobel Prize in Chemistry. In this example, an **Excision Nuclease** recognizes a pyrimidine dimer and hydrolyzes phosphodiester bonds between nucleotides several bases away from either side of the dimer. A **DNA helicase** then

unwinds and separates the DNA fragment containing the dimerized bases from the damaged DNA strand. Finally, **DNA polymerase** acts 5'-3' to fill in the gap and **DNA ligase** seals the remaining nick to complete the repair.

3. Mismatch repair

DNA Mismatch Repair is needed when an incorrect base is accidentally incorporated into a new DNA strand during replication. This repair mechanism relies on the fact that double-stranded DNA shows a specific pattern of methylation. The discovery of the *mismatch repair* mechanism earned Paul Modrich a share in the 2015 Nobel Prize in Chemistry. These methylation patterns are related to epigenetic patterns of gene activity and chromosome structure that are expected to be inherited by daughter cells. When DNA replicates, the methyl groups on the template DNA strands remain, but the newly synthesized DNA is unmethylated. In fact, it will take some time before methylation enzymes locate and catalyze methylation of appropriate nucleotides in the new DNA. In the intervening time, several proteins and enzymes are able to detect inappropriate base pairing (the mismatches) and initiate mismatch repair. The basic process is illustrated below.

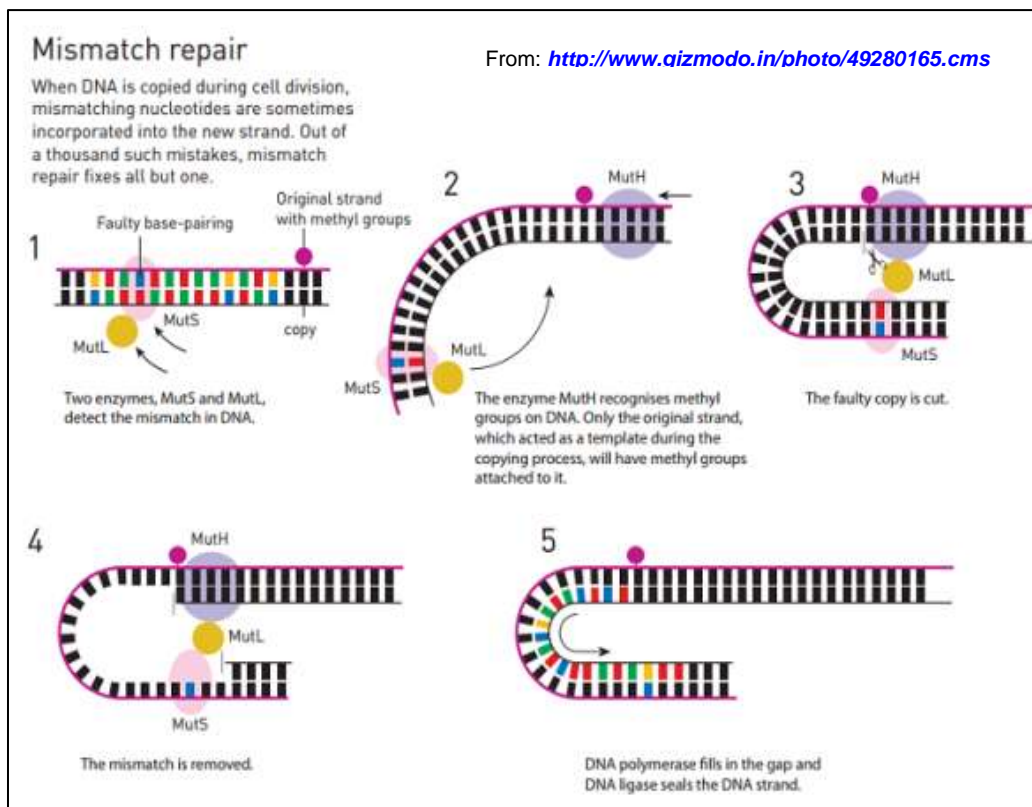

4. *Transcription Coupled Repair* (in Eukaryotes)

If an RNA polymerase reading template DNA encounters a nicked template or one with an unusual base substitution, it might stall transcription and “not know what to do next”. Thus at a loss, a normal transcript would not be made and the cell might not survive. No big deal in a tissue comprised of thousands if not millions of cells, right? Nevertheless, ***Transcription Coupled Repair*** exists! In this repair pathway, if ***RNA polymerase*** encounters a DNA lesions (i.e., damaged DNA) while transcribing a template strand, it will indeed stall. This allows time for ***coupling proteins*** to reach the stalled polymerase and enable repair machinery (e.g., by base, or nucleotide excision) to effect the repair. Once the repair is complete, the ***RNA polymerase*** ‘backs up’ along the template strand with the help of other factors, and resumes transcription of the corrected template.

5. *Non-homologous End-Joining*

DNA replication errors can cause ***double stranded breaks***, as can environmental factors (ionizing radiation, oxidation, etc.). DNA repair by ***non-homologous end-joining*** works by deleting damaged and adjacent DNA and rejoining the ‘cut’ ends (see below).

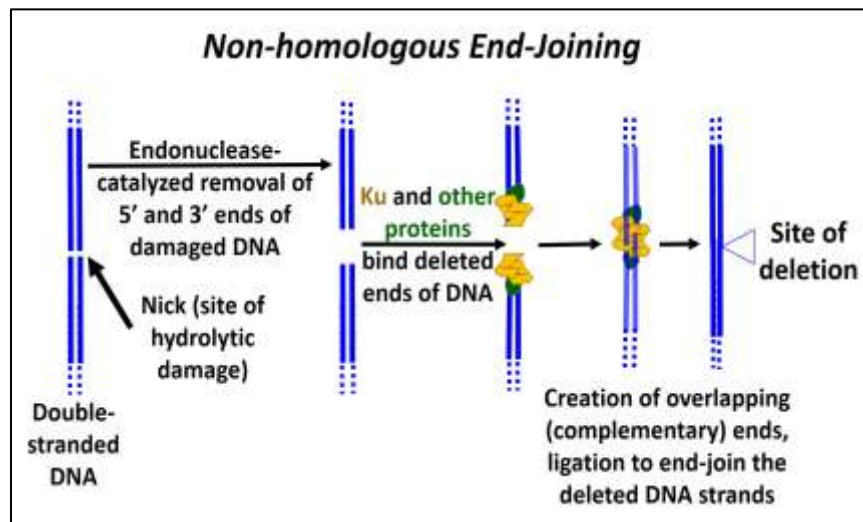

Once the site of the double-stranded break is recognized, nucleotides are ***hydrolyzed*** from the ends of both strands at site of damage (break), leaving ‘*blunt ends*’. Next, several proteins (***Ku*** and others) bring DNA strands together and further hydrolyze single DNA strands to create staggered (overlapping, or ***complementary***) ends. The overlapping ends of these DNA strands form H-bonds. Finally, the H-bonded

overlapping ends of DNA strands are re-sealed by **DNA ligase**, leaving a repair with deleted bases. In older people, there is evidence of more than 2000 'footprints' of this kind of repair per cell. How is this possible? This *quick-fix* repair often works with no ill effects because *most of the eukaryotic genome doesn't encode genes* or even regulatory DNA (whose damage would otherwise be more serious).

- **Homologous Recombination**

Homologous recombination is a normal (and frequent) part of meiosis in eukaryotes. You may recall that **homologous recombination** occurs in **synapsis** in the first cell division of **meiosis** (Meiosis I; consult the genetics chapter in an introductory biology textbook, or the recombination chapter in a genetics text to remind yourself of these events). During synapsis, homologous chromosomes will align. This may result in DNA breakage, an *exchange* of alleles, and ligation to reseal the now recombinant DNA molecules. It is the novel recombination of variant **alleles** in the chromosomes of sperm & eggs that ensures **genetic diversity** in species. The key point is that DNA breakage of DNA is required to exchange alleles between **homologous chromosomes**.

The same machinery that handles and reseals DNA breaks during normal recombination can be used by cells to repair DNA damaged by single or double stranded breakage. A single DNA strand nicked during replication can be repaired by recombination with strands of homologous DNA being replicated on the other strand. A double stranded break can be repaired using the same recombination machinery that operates on sister chromatids in meiosis. In both cases, the process accurately repairs damaged DNA **without any deletions**.

These mechanisms are conserved in the cells of all species. This indicates an evolutionary imperative of this kind of accurate repair to the survival of species, no less than the imperative to maintain genetic diversity of species.

- a) A specific example of homologous recombination repair is the re-establishment of a replication fork that is damaged when a replisome reaches a break in one of the two strands of replicating DNA. In this case, the break may have occurred prior to replication, and repair events begin when the replication fork (RF) reaches the lesion.

The role of homologous recombination in repairing a single-stranded DNA break is illustrated below.

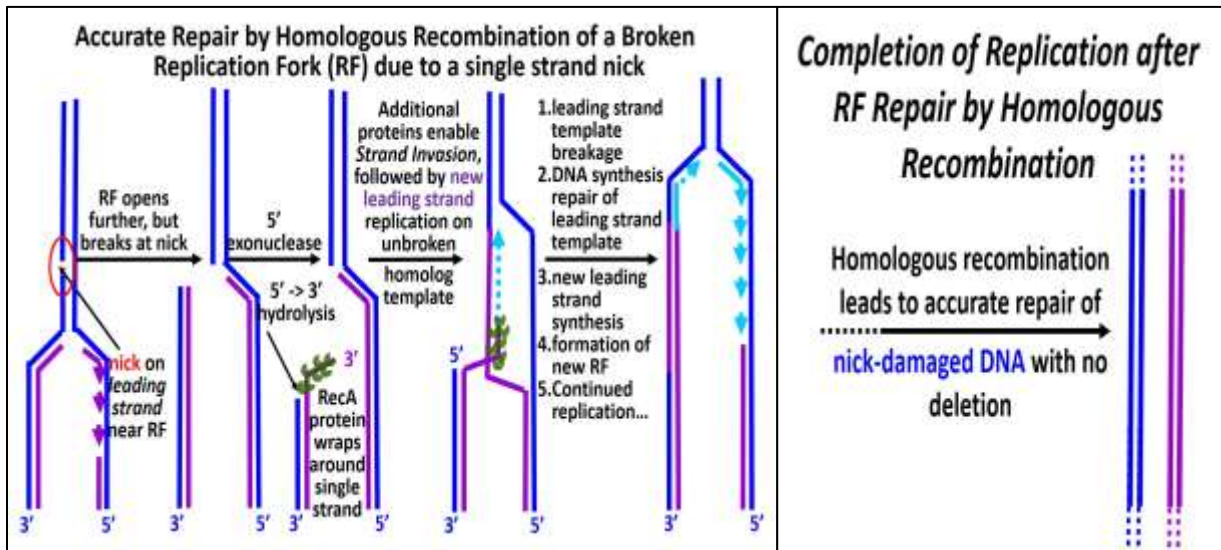

A **5'-3' exonuclease** first trims template DNA back along its newly synthesized complement (shown in purple). **RecA** protein monomers (shown in green above), each with multiple DNA binding sites, bind to the single-stranded DNA to form a nucleoprotein filament. With the help of additional proteins, the 3' end of the 'filament' scans the 'other' replicating strand for homologous sequences. When such sequences are found, the RecA-DNA filament binds to the homologous sequences and the filament of new DNA 'invades' the homologous (i.e., opposite) double stranded DNA, separating its template and newly replicated DNA. After **strand invasion**, replication of a leading strand continues from the 3' end of the invading strand (shown in light blue). A new RF is established as the leading strand template is broken and re-ligated to the original break, and as new lagging strand replication begins again at the new RF. The result is an accurate repair of the original damage, with no deletions or insertions of DNA.

RecA, a bacterial protein, is another of those evolutionarily conserved proteins. Its homolog in Archaea is called **RadA**. In Eukaryotes, the homolog is called **Rad51**, where it initiates **synapsis** during meiosis. So it seems that a role for **RecA** and its conserved homologs in DNA repair predated its use in synapsis and crossing over in eukaryotes! Read more about the functions of RecA protein and its homologs at <https://en.wikipedia.org/wiki/RecA>.

- b) Homologous recombination can also repair a double-stranded DNA break with the aid of a number of enzymes and other proteins. Alternate repair pathways are summarized in the following drawing.

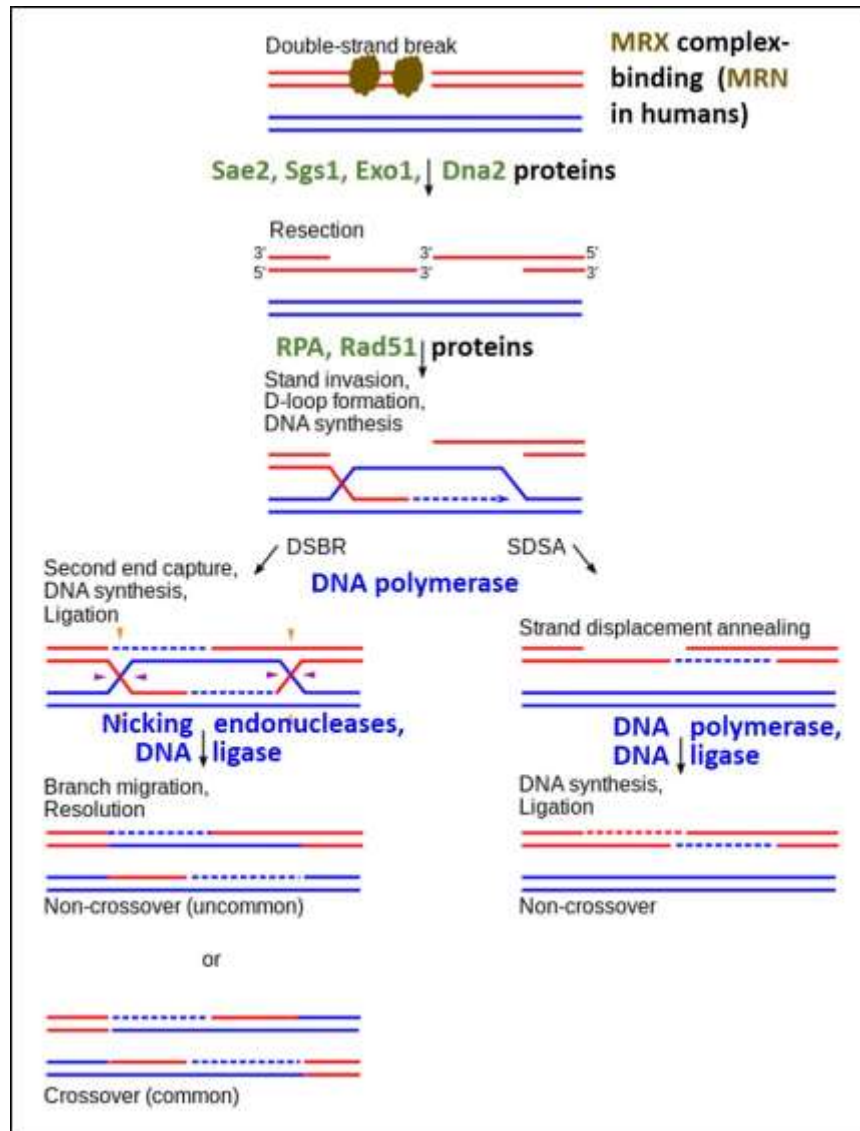

Here is a list of proteins involved in these homologous recombination pathways:

MRX, MRN: bind at double-stranded break; recruit other factors.

Sae2: an endonuclease (active when phosphorylated).

Sgs1: a helicase.

Exo1, Dna2: single strand exonucleases.

RPA, Rad51, DMC1: proteins that bind to overhanging DNA to form a nucleoprotein filament and initiate *strand invasion* at similar sequences.

The activities of other enzymes in the drawing are identified. Not shown in this illustration are two gene products that interact with some of the proteins that mediate the repair pathway. These are products of the BRCA1 and BRCA2 genes (indeed, the ones that when mutated, increase the likelihood of a woman getting breast cancer). Expressed mainly in breast tissue, their wild-type (normal) gene products participate in homologous recombination repair of double-stranded DNA breaks. They do this by binding to Rad51 (the human RecA homolog!). When mutated, these proteins cannot function properly and DNA in the affected cells is not repaired efficiently, which is the likely basis of the increased chance of getting breast cancer. It doesn't help matters that the normal BRCA1 protein also plays a role in mismatch repair... and that the mutated protein can't!

And to end this chapter, here is a bit of *weird science!* Read all about the genome of a critter, nearly 17% of which is comprised of foreign DNA, possibly the result of [Extreme DNA Repair of the Spaced-Out Tardigrade Genome](#)

Some iText & VOP Key Words and Terms

10 nm fiber	env	RadA protein
30 nm fiber	euchromatin	RecA protein
5' -to-3' replication	helicase	replication
antiparallel DNA strands	heterochromatin	replication fork
base excision repair	high-speed blender	replicons
base ratios	histone octamer	replisome
beads-on-a-string	histone proteins	S phase of the cell cycle
bidirectional replication	influenza	<i>S. pneumonia</i> type III-S
BRCA genes	initiation	<i>S. pneumonia</i> type II-R
Central Dogma	initiator proteins	satellite DNA
chromatin	karyotype	semi-conservative replication
chromosomes	lagging strand	single-strand binding proteins
clamp proteins	leading strand	siRNA
condensation reactions	levels of chromatin packing	solenoid fiber

conservative replication	metaphase chromatin	spindle fibers
deamination	methylation	supercoiling
density gradient centrifugation	mitosis & meiosis	T2 phage
deoxyribonuclease	mutations	tardigrade
depurination	non-histone proteins	telomerase
direct repeats	nuclear proteins	telomeres
discontinuous replication	nucleosomes	tetranucleotide hypothesis
dispersive replication	nucleotide excision repair	theta images
DNA	Okazaki fragments	topoisomerases
DNA ligase	origin of replication	transcription-coupled repair
DNA mismatch repair	phosphate backbone	transforming principle
DNA polymerase I, II and III	phosphodiester linkage	transposase
DNA repair	primase	triplets genetic code
DNA sequence phylogeny	primer	VLP
DNA strand breakage	processive replication	VNTRs
DNA topology	proofreading	X & Y chromosomes
double helix	pyrimidine dimers	X-ray crystallography
elongation	pyrophosphate	X-ray diffraction

Chapter 9: Repetitive DNA, A Eukaryotic Genomic Phenomenon

Mini-Satellite DNA, Microsatellite DNA, Telomeres, Ribosomal RNA genes, Transposons (Architects of the Genome or Selfish, Junk DNA?)



Mexican jumping genes... maybe not!

<http://tse2.mm.bing.net/th?id=OIP.M6dce919ae2d3ad7d69129860a16c4caa0&pid=15.1>

II. Introduction

Repetitive DNA sequences make up a large part of a eukaryotic genome. Much of repetitive DNA consists of identical or nearly identical sequences of varying length that are repeated many times in a genome. Examples include satellite DNA (mini- and microsatellite DNA) and transposable elements (transposons). In this section, we'll discuss early experiments demonstrating the existence and proportion of repeated DNA in the genome. Then we'll describe Barbara McClintock's even earlier (and pretty amazing!) discovery of transposable elements. Finally, we'll review the different classes of transposons, how they "jump" and how, far from being "junk" DNA, transposons and other repetitive DNA have specific functions, including reshaping genomes and increasing genetic diversity in evolution.

Voice-Over PowerPoint presentations

[Repetitive DNA](#)

[The Discovery of Mobile DNA \(Transposons\)](#)

[DNA Transposons](#)

[Retrotransposons, Retroposons and Retroviruses](#)

Learning Objectives

When you have mastered the information in this chapter and the associated VOPs, you should be able to:

1. compare and contrast *renaturation kinetic data*
2. explain *CoT curves* for different organisms and predict likely *CoT* data for a species for which there is no renaturation data
3. define and explain *DNA complexity*
4. describe how Barbara McClintock demonstrated how “instability” of the *Ds gene* caused mosaic maize kernel color
5. explain the experiments that led to the conclusion that *Ds* must be moving from one place to another in the maize genome
6. compare and contrast *cut-&-paste* and *replicative transposition*
7. list physical and chemical properties of *main band* and *satellite DNAs*
8. outline an experiment to determine if a given sequence of DNA is repetitive or not
9. compare and describe the behavior of *autonomous* and *non-autonomous* transposons
10. list the differences between Mu phage infection and transposition
11. explain the common features of all transposons... and the differences between them
12. consider whether a LINE must be actively transposon for a SINE to do so
13. list relationships between transposon components and behavior that have counterparts in well-known genomic structures and functions
14. speculate on how species avoid the potentially lethal consequences of transposition
15. speculate on which came first in evolution: the DNA transposon, retrotransposon, retroposon or retrovirus

II. The Complexity of Genomic DNA

By the time that Roy Britten and Eric Davidson were studying eukaryotic gene regulation in the 1960s, they knew that DNA was informationally complex, i.e., that there was more than enough DNA sequence diversity to account for the genes required to encode an organism. They knew too, that DNA might be structurally more complex. This was based on **CsCl density gradient centrifugation** in which naturally sheared DNA (DNA is quite fragile) did not as might be expected, migrate as a single band with a uniform density. Rather, such DNA isolates resolved a main band as well as a band containing less DNA that was often less dense than the main band. This smaller band was dubbed **satellite DNA**, (recalling the recently launched man-made Sputnik satellite). It was less dense than the main band because it had a higher AT content. Britten and Davidson also knew that the eukaryotic

genome was large. So large that, even with inflated estimates of the number of genes it took to make a human a chicken a rat or a petunia (e.g., 100,000 genes), there are 100-1000 times more DNA than necessary to account for those genes.

Eukaryotic (unlike prokaryotic) genes are not organized into operons, so that coordinated regulation of genes dispersed along chromosomes would require multiple redundant copies of regulatory DNA sequences (to interact with the same regulatory protein). A reasonable assumption was that some of the extra 'non-coding DNA' in the genome would consist of these repetitive regulatory DNA sequences. Britten and Davidson's elegant **renaturation kinetics** experiments revealed the relative amounts of repeated and unique (or single-copy) DNA sequences in the genome, defined as the **genomic complexity**. Let's look at these experiments in some detail.

The first step was to shear DNA isolates to an average size of 10 Kbp, which could be done by pushing high molecular weight DNA through a hypodermic needle at constant pressure. These double-stranded fragments (dsDNA) were then heated to 100°C to denature (separate) them. Then, the solutions were cooled to 60°C to allow the ssDNA fragments to slowly re-form complementary double strands. The experiment is summarized in the drawing below.

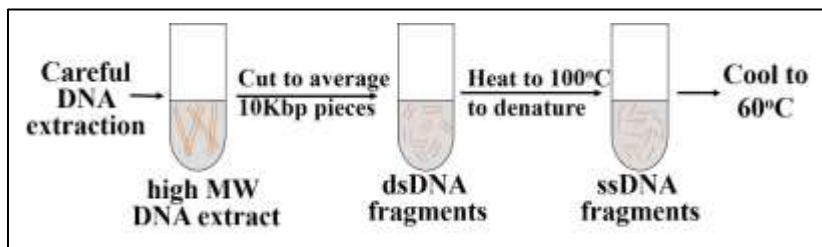

At different times after incubation at 60°C, the partially re-natured DNA was sampled and ssDNA and dsDNA were separated and quantified. The amount of dsDNA formed at different times (out to many days!) was plotted on a graph. The data for such an experiment for rat DNA is shown below.

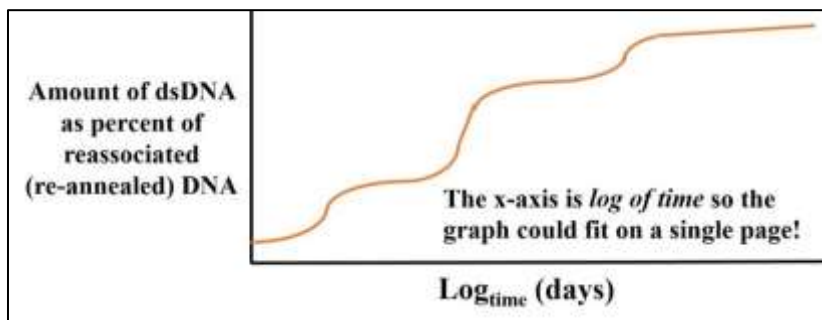

The results showed that the DNA fragments seem to be divided into several (3) groups. The dsDNA that had formed most rapidly were sequences that must be more highly repetitive than the rest of the DNA. The rat genome also had a lesser amount of more moderately repeated dsDNA fragments that took longer to anneal than the highly repetitive fraction, as well as a very slowly re-annealing fraction of sequences. The latter sequences were so rare in the extract that it might take days for them to re-form double strands. These interpretations are illustrated below.

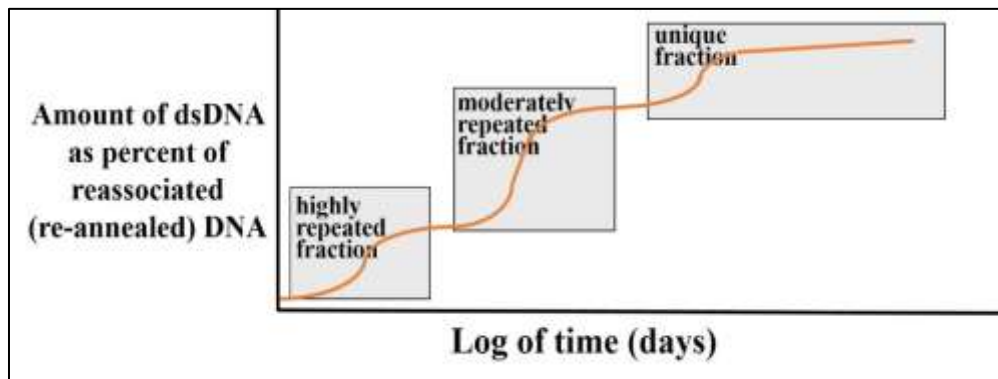

The rat genome, and in fact most eukaryotic genomes consist of these different classes of DNA that differ in their redundancy. From the graph, a surprisingly large fraction of the genome was repetitive to a greater or lesser extent. When the same experiment was done using *E. coli* DNA, only one 'redundancy class' of DNA was seen (below).

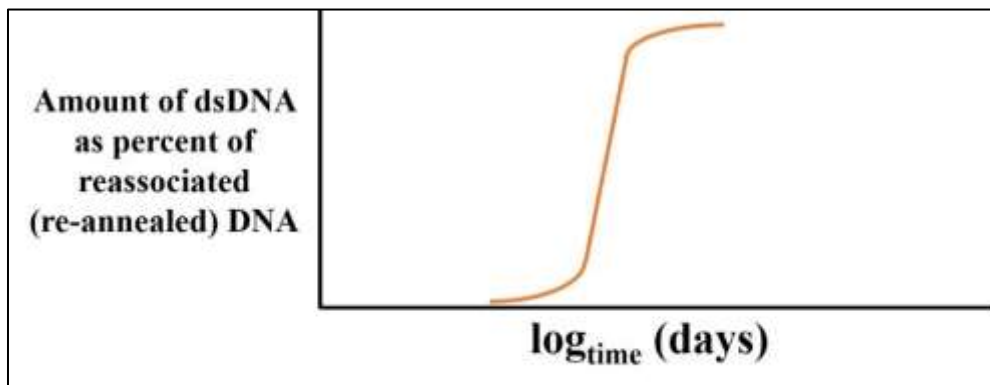

It looks like there is only one 'redundancy' class of bacterial DNA. Because the *E. coli* genome is so much smaller than a rat (or any eukaryotic) genome, the assumption was that there is little room for repetitive DNA in a bacterial genome..., and that the single class of DNA on this plot must be unique-sequence DNA.

This difference between eukaryotic and prokaryotic **genome complexity** could be demonstrated by a simple expedient. Instead of plotting the fraction of dsDNA formed over time, plot the percent of re-associated DNA against the *concentration of the re-natured DNA multiplied by the time that DNA took to reanneal* (the *CoT value*). When the rat and *E. coli* re-naturation data are plotted on the same graph, the CoT curves allow a direct comparison of the complexity of the two genomes.

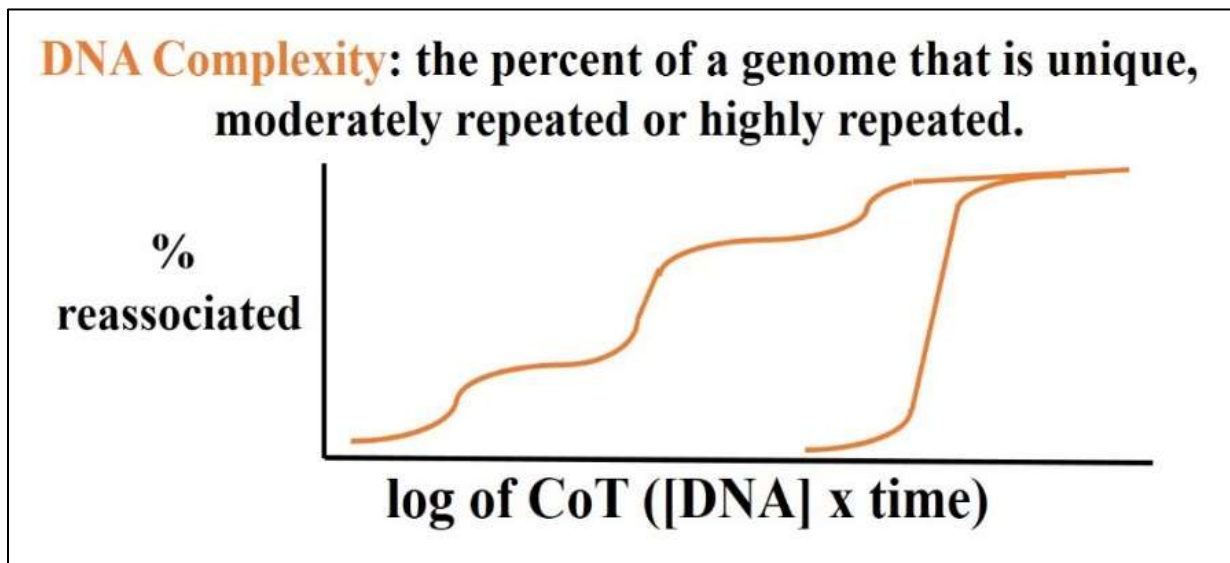

This deceptively simple expedient allows comparison of the *complexities* of any genome. From this CoT curves on this graph, ~100% of the bacterial genome consists of unique sequences, compared to the rat genome with its 3 classes of DNA.

So... prokaryotic genomes are largely composed of unique (non-repetitive) sequence DNA, most of which are genes or operons that encode proteins, along with genes that encode rRNAs and tRNAs. But what's the situation in eukaryotes? Just what kinds of sequences are repeated, and what kinds are 'unique'? Perhaps it was the satellite DNA, ribosomal RNAs and transposable elements (which were known to exist by the late 1960s) that belonged to the repetitive DNA classes.

In fact, satellite DNA isolated from the CsCl gradients could be made radioactive and shown to hybridize with the highly repetitive class of eukaryotic (e.g., rat) DNA isolable from the renaturation experiments. With the advent of recombinant DNA technologies, the redundancy of other kinds of DNA could be explored. Cloned genes encoding rRNA, proteins, transposons and other sequences were used to probe DNA fractions obtained from renaturation kinetics experiments.

The results of such experiments are shown in the table of eukaryotic genomic complexities (below) comparing unique sequence DNA with different kinds of repetitive sequence DNA, along with their genomic copy numbers and functions.

Repetitive DNAs in Eukaryotes

Class	Type	Copy number; % of Genome e.g. Mammals	Sub-type	Organization */or Properties	Unit Length (bp)	Location	Function (if known), Examples
Highly Repetitive	Satellite DNAs	Up to 10 ⁶ ; 10-15%	Microsatellite	Tandem repeats (*VNTRs)	2-8 bp X 5-50	Centromeres, Heterochromatin, Dispersed	Spindle fiber attachment, gene regulation
			Minisatellite	Tandem repeats (*VNTRs)	10-60 bp X ?	Dispersed	Gene Regulation
			Telomeres (sub-category of minisatellite DNAs)	Tandem Repeats	4-6 bp	Chromosome ends	Prevent chromosome shortening during replication
Moderately Repetitive	Transposable Elements	10-10 ³ ; 20-45% (>80% in Maize!)	DNA Transposons	Move via DNA intermediates ("cut-&Paste")	Up to 7,000 bp	Dispersed	P-element, Mariner, Ac, Ds
			Retrotransposons: LTR elements, LINES & SINES	Move via RNA intermediates	80-400 bp (SINES),	Dispersed	Alu
					Up to 7000 bp (LTR, LINES)	Dispersed	L1
	rRNA genes	<1%	45S rRNA genes	Tandem 45S rDNA repeats	13.7 Kbp	Nucleolus	Translation
			5S rRNA genes	Tandem 5SrDNA repeats	120 bp	Dispersed	Translation
Unique Sequence	Transcribed genes, introns, intergenic DNA	Single copy sequences; ~50% in aggregate	Protein-coding genes (introns + exons)	~25000 in humans	variable	Dispersed	Just about everything else!

* VNTR: Variable Number of Tandem Repeats

In sum, most of a eukaryotic genome is made up of repeated DNA! Since “jumping genes” (or transposons) make up a fair amount of this DNA, we’ll focus next on the different transposable elements.

III. The ‘Jumping Genes’ of Maize

Barbara McClintock’s report that bits of DNA could jump about and integrate themselves into new loci in DNA was so dramatic and arcane that many thought the phenomenon was either a one-off, or not real! Only much later, with the discovery of transposons in bacteria and eukaryotes, were McClintock’s mobile genetic elements finally recognized as real.

As we describe her experiments, keep in mind that McClintock’s transposon research and intuitions about gene regulation and **epigenetic** inheritance came decades before molecular technologies made it possible to prove and give names to these phenomena. To begin our tale of transposons, we need to know something about reproduction of maize. Consider the illustration below.

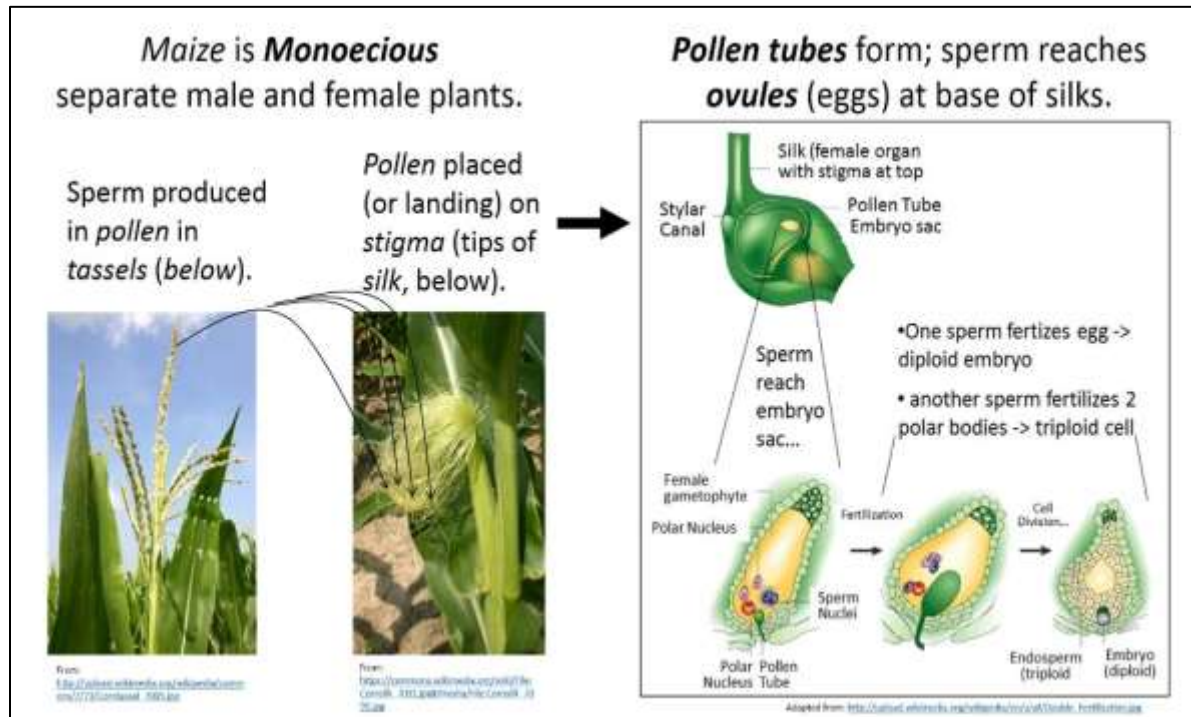

McClintock was studying color variation in the **aleurone** layer of the seeds, the protective **outer layer** of corn kernels, derived from **triploid endosperm** tissue shown above). The different colors of the kernels results from **anthocyanin pigments** that are expressed differentially by cells of the aleurone tissue. Examples of mosaic corn cobs are shown in the photograph below.



Clearly, **Coloration** (purple), colorless (white or yellow) or variegated (**mosaicism**, or spotted/streaked) of maize **kernels** (seeds) is inherited. But mosaic color patterns after genetic crosses were not consistent, implying that the mutations responsible for kernel color were not due to mutations in germ cells. Rather, genes controlling anthocyanin synthesis must be undergoing mutations in somatic cells, presumably the ones in which the pigments were produced.

McClintock was looking for a genetic explanation for this seed color variation in the 1940s and early 1950s. At this time, DNA structure had only been recently published and gene cloning and DNA sequencing were a decade or more in the future! The technologies available to her were based on Mendelian allelic assortment in traditional breeding studies. But McClintock realized that the inheritance of kernel color **phenotype** must be studied against a **triploid** genetic background. She knew that variegated color had been proposed to result when an '**unstable mutation**' that produced colorless kernels '**reverted**' in some cells but not others to create a spotted or streaked phenotype. McClintock ultimately identified three genes that must be involved in seed kernel coloration.

CHALLENGE: Not now..., but later in your readings in the text, you should be able to design an experiment based on molecular technologies that could quickly revealed how transposons influence maize mosaicism.

Two of the genes initially studied by McClintock controlled the presence vs. absence of kernel color. These are the **C** and **Bz** genes:

1. **C'** is the dominant allele of the C gene, called the *inhibitor allele* because if even one copy was present, the kernels would be **colorless** (yellow), regardless of the rest of the genetic background.
2. **Bz** and **bz** are respectively, the dominant and recessive alleles of the Bz gene. In the absence of the C' (dominant) allele, a Bz allele would lead to purple kernels). If the bz allele were present in the absence of both C' *and* Bz alleles the kernels would be dark brown.
3. The gene required to get variegated kernel color was named **Ds** (the **Dissociator gene**). Without a viable **Ds** gene, kernels were either colored or colorless depending on the possible genotypes dictated by the C and Bz alleles. Because the **Ds** gene effect was random and only affected some aleurone layer cells, it was suspected to be a region of *chromosomal instability* (prone to damage or breakage) in some cells but not others.

Let's look at what McClintock did to figure out what was going on in corn kernel color genetics. Having earlier demonstrated crossing-over in maize (actually, another remarkable achievement!), McClintock **mapped** the 3 genes to *Chromosome 9*. She then selectively bred & mated corn with the genotypes illustrated below.

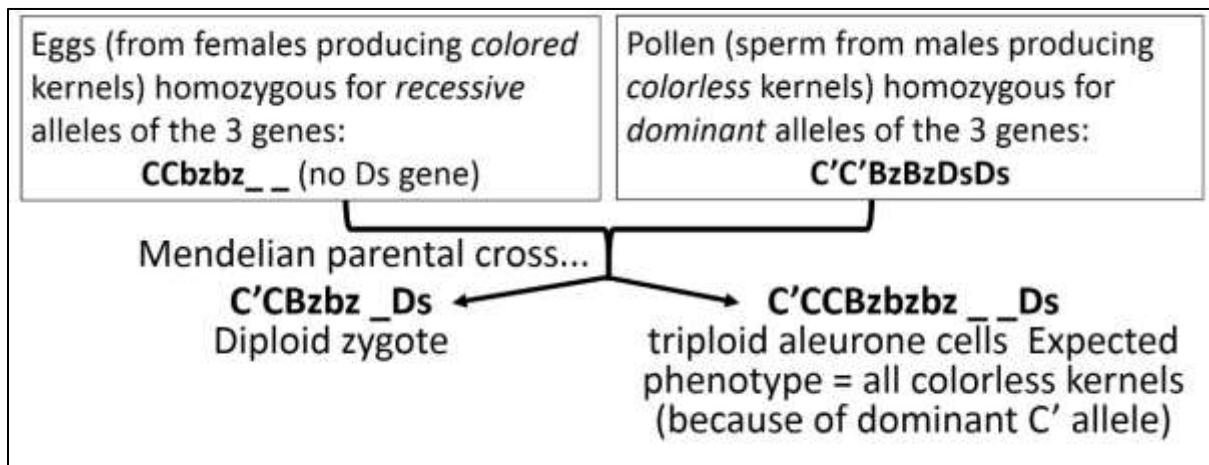

As a reminder, note that the genotypes of triploid cells are being considered in this illustration. You can refer to the phenotypic effects of the allelic backgrounds of three genes as we follow this cross of McClintock's cross of homozygous recessive with homozygous dominant plants should ring a bell! Let's look more closely at this cross. The expected genotypes from the cross are shown below.

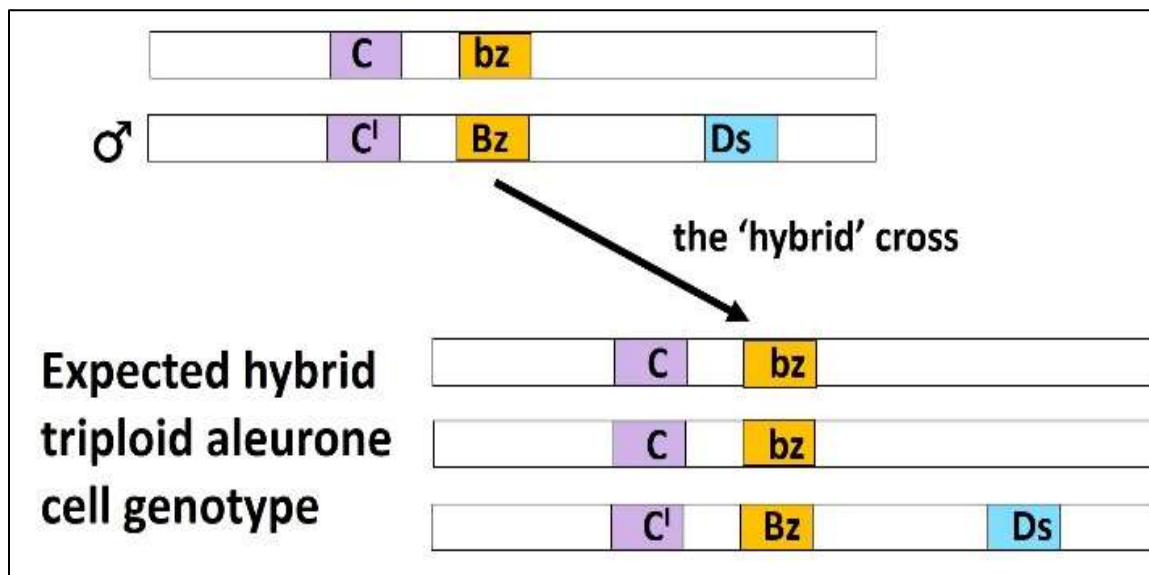

Aleurone cells resulting from this cross should all be colorless (yellow) because of the presence of the dominant C' allele. However, while there were indeed many **colorless** kernels on the *hybrid* cob, there were also many **mosaic** kernels with dark spots/streaks against a colorless background. McClintock's interpretation of events is illustrated below.

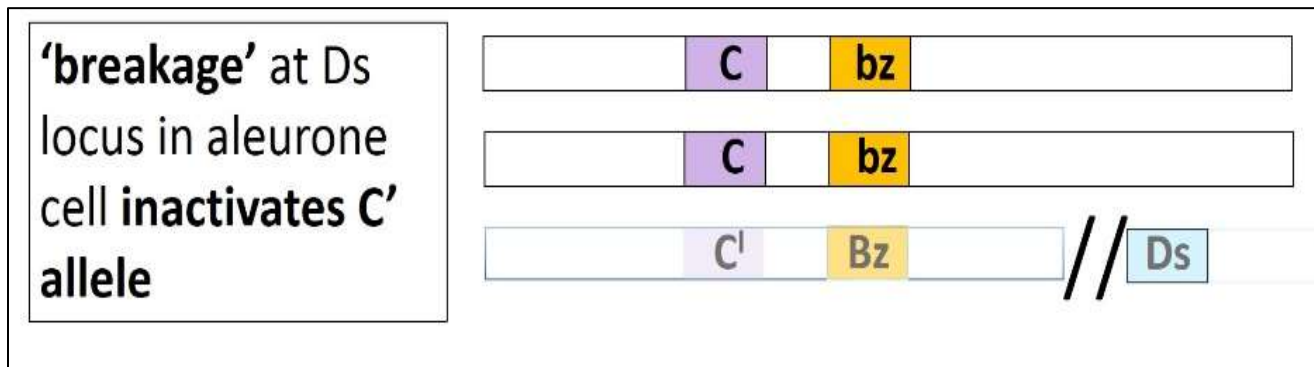

According to McClintock, if some aleurone layer cells in some kernels suffered chromosome breakage (indicated by the double slash, //) at the **Ds (Dissociator)** locus, the C' allele is inactivated. Without a functional C' allele, the **operative** genotype in the affected cells is **CCbzbz**. These cells then revert to making pigment as directed by the *bz* allele, making brown pigment spots or streaks against the colorless background created by the cells with an unbroken chromosome and therefore an active C' allele.

These experiments were reproducible using a single breeding stock. But when McClintock tried to repeat the experiments by crossing the homozygous dominant males with homozygous recessive females from a *different* breeding stock, all the kernels of the progeny cobs were colorless, as if the *Ds* gene had not caused any chromosomal damage. It seemed that the **Ds** gene contributed by the male was unable to function (i.e., 'break') in females of this new breeding stock. McClintock hypothesized that the female in the original cross must have contributed a factor that could somehow activate the *Ds* gene to break, and that this factor, another gene, was absent or inactive in the females of the new breeding stock.

McClintock called the new factor the **activator**, or **Ac** gene and demonstrated that Ac-dependent *Ds* 'breakage' was in some cases associated with inactivation of a normal *Bz* gene, leading to a loss of purple color kernels. It was at this point that McClintock concluded that far from simply 'breaking' the chromosome at a fragile *Ds* locus, *the Ds gene had actually moved to (or into) the Bz gene*, disrupting its function. Again, this could not happen absent an active *Ac* gene. McClintock had discovered the first transposon, long before they were found in bacteria and then in eukaryotes. For this, she was awarded the Nobel Prize in 1983!

With the advent of recombinant DNA technologies, we now know that

- the Ds element lacks a key gene for a **transposase** enzyme necessary for transposition
- the Ac element has this gene and is capable of independent transposition,
- The Ac element can provide the transposase needed to mobilize the Ds element.
- Ds and Ac sequences are otherwise related.

Based on the dependence on **Ds** on the **Ac** locus, the loci are recognized as a 2-element, **Ac/Ds system** influencing mosaicism in maize kernels. DS and Ac transposition share similarities with other transposons. The basic features of the maize Ac/Ds system are:

- Ac is 4563 bp long
- Ds is a truncated version of Ac.
- There are **11 bp inverted repeats** at either end of the Ac and Ds element
- There are **8 bp direct repeats** (NOT inverted repeats) of 'target DNA' at the site of insertion of either transposon.

Look for these features in the different classes of prokaryotic and eukaryotic transposable elements that we are about to describe...

IV. Transposons Since McClintock

Transposons have been found everywhere in prokaryotes and eukaryotes. While eukaryotic transposons make up a large proportion of genomes and account for much of their repetitive DNA, most of them were mobile a long time ago and can no longer transpose. Once considered **junk DNA**, or **selfish genes**, transposons are increasingly being shown to function in genetic regulation, and to play a role in evolutionary diversity (check out these links for more: [Not junk after all?](#) and [Eulogy for Junk DNA](#)).

As you will see, the mechanisms of transposition include many features of DNA replication, recombination and repair, not to mention common features with viral infection. As you study the mechanisms of transposition, keep in mind that the mobility of transposition is often triggered by cellular stress.

A. Bacterial Mobile Elements

Insertion Sequences were the first mobile elements discovered after McClintock's maize Ac and Ds mobile genetic elements. Because they share features of eukaryotic transposons, and because they can carry antibiotic resistance genes, we'll take a brief look at insertion sequences (**IS elements**) and bacterial transposons derived from them.

IS elements were discovered in the late 1960s and subsequently described in some detail. There are now many known *IS elements* (e.g., IS1, IS2..., IS10 etc.). While some are found in well-known genes (e.g., those of the lac operon), most are not.

CHALLENGE: So, if transposons ‘jumping’ into locations near or within genes cause deleterious mutations, what’s going on in this case?

IS elements they can be shown (or experimentally caused) to transpose, they are generally silent, if only in the sense that prokaryotic genomes are compact, with little ‘extra’ DNA (unlike the seemingly ‘bloated’ eukaryotic genomes). With such a small genome, transposition in a bacterial cell has a far greater likelihood of mutating an essential gene, in which case, the cell would not survive to tell a tale of transposition!

Members of the IS element family range in length from about 750 to 1425 bp. Within this stretch of DNA lie **transposase** and **resolvase** genes whose products are necessary for mobility. At either end of the IS element are **inverted repeats**, and when found in either genomic or plasmid DNA, the IS sequence itself is flanked by **direct repeats** of host genome or plasmid DNA that result from the mechanism of transposition.

Again, because of their compact genomes, bacteria can only tolerate low copy numbers of IS or Tn elements in their genome or on plasmids (less than 10 copies and as few as 1!). A typical IS element is illustrated below.

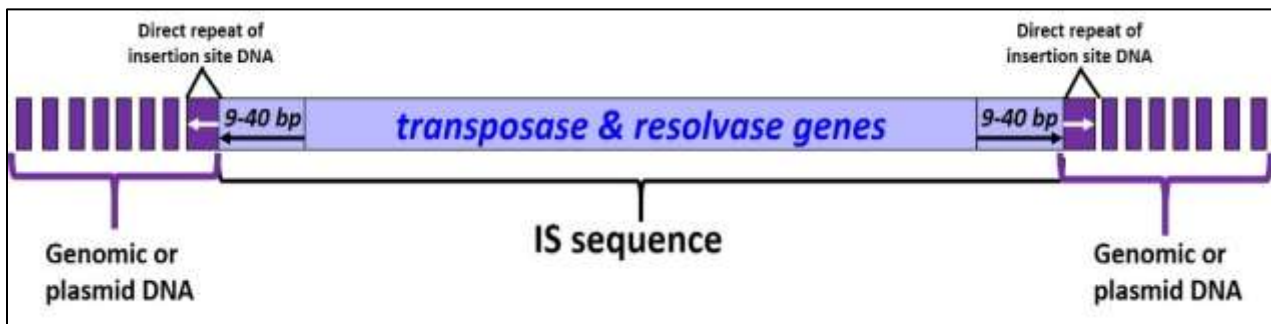

If a pair of IS elements should lie close to each other, separated by a stretch of genomic or plasmid DNA, they can transpose together, carrying the DNA between them as part of a **composite transposon**, or **Tn element**.

Tn elements, often found on plasmids, typically contain antibiotic resistance genes (below).

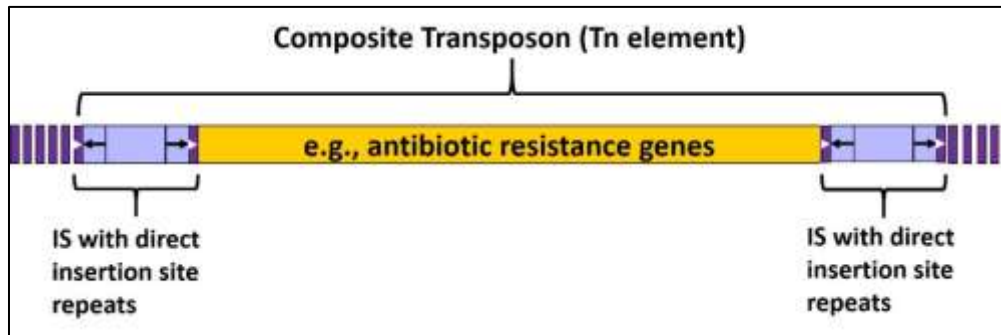

Plasmids often carry antibiotic resistance genes. This has the medical community worried since antibiotic-resistant pathogens cause disease that is becoming increasingly hard to treat. As part of **F**, or **fertility plasmids** that normally transfer DNA between compatible bacterial mating types, a pair of IS elements may find themselves flanking an antibiotic resistance gene. After transfer of the F plasmid to a recipient bacterium (look up bacterial conjugation for more info), this composite Tn element can transpose into to the bacterial genome. The result is transfer of antibiotic resistance genes to the bacterial chromosome. Transposition is thus a major pathway for the transfer and spread of antibiotic resistance.

Complex Transposons in bacteria can contain other genes in addition to those required for mobility. Some resemble a bacteriophage, or as in the case of **phage Mu**, actually are a phage, but one that can function either as a phage able to lyse an infected cell and then infect new cells, **OR** as a transposon, moving from DNA site to DNA site within the bacterial genome. The structure of Mu is illustrated here.

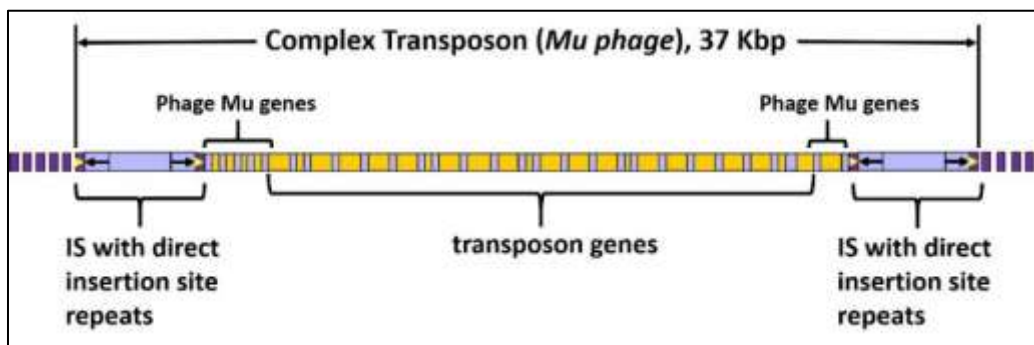

After infection, Mu can enter the lytic phase of its life cycle, reproducing and ultimately releasing new infections phage 'particles' by lysing the host bacterial cell.

Like other phage, Mu can instead undergo lysogeny, integrating into the host cell chromosome. Integrated copies of Mu might excise and re-enter the lytic phase to produce more phage, particularly if some environmental stress threatens host bacterial survival. The life cycle of a **temperate** bacteriophage is illustrated below (**virulent** phage only use the lytic pathway).

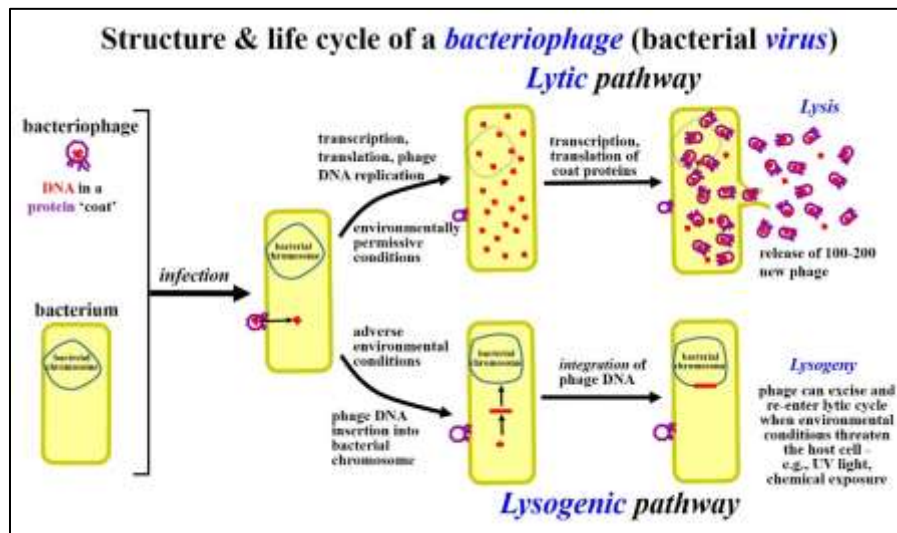

To see an animation of these two pathways of bacteriophage infection, click <https://youtu.be/UoBHCTv6FLA>. The lifestyle choices of phage Mu after lysogeny also include transposon behavior. A summary of phage Mu lifestyle choices is drawn below.

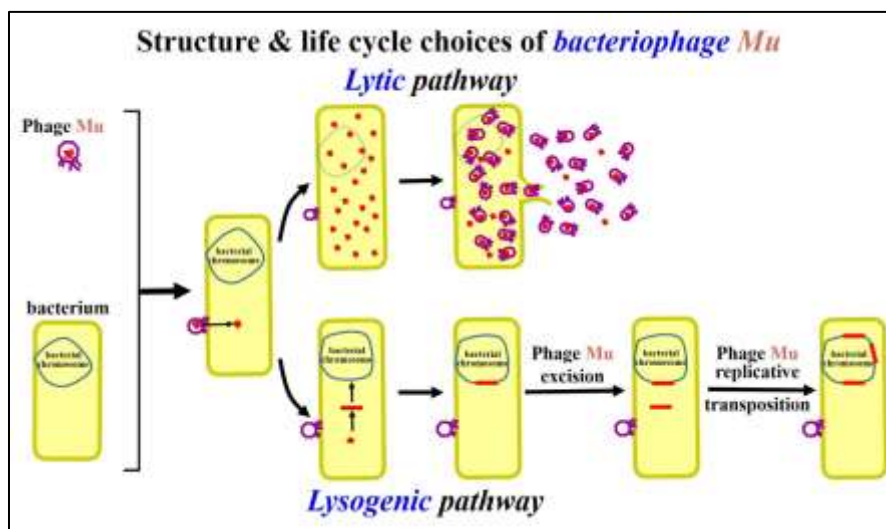

As we now turn to a description of eukaryotic transposons, watch for similarities to IS and Tn elements.

B. Eukaryotic Transposable Elements

Among eukaryotes there are two classes of transposons:

Class I (Retrotransposons) that move/'jump' by transcription of RNA at one locus, followed by reverse transcription and integration of the cDNA back into genomic DNA at a different location. Retrotransposons may be derived from (or be the source of) retroviruses. This is suspected because active retroviruses excise from and integrate into DNA much like retrotransposons.

Class II (DNA Transposons) that move/jump either by

- a cut-&-paste pathway, leaving one locus and integrating at another, or
- a replicative mechanism leaving the original transposon in place and transposing the copy/copies.

The table below shows the distribution, average copy number and proportion of genomes represented by different classes/types of transposable elements.

Proportions of DNA and RNA transposons in Different Organisms:

Organism	Class I Transposons (Retroposons) as proportion of all transposons	Retroposons as % of Genome	Class II Transposons (DNA Transposons) as proportion of all transposons	DNA transposons as % of Genome	All Transposons as % of genome
Bacteria (e.g., <i>E. coli</i>)	-----	-----	100%	~3%	~3%
Yeast	100%	~3.5%	-----	-----	~3.5%
Corn (e.g., <i>Z. maize</i>)	>50%	~30-45%	<50%	~40%	~70-95%
Protozoa (<i>T. Vaginalis</i>)	-----	-----	100%	~66%	~66%
Frog (e.g., <i>R. esculenta</i>)	~25%	~19%	~75%	~58%	~77%
Mouse (<i>M. Musculus</i>)	~95%	~38%	~5%	~2%	~40%
Mosquito (e.g., <i>A. aegypti</i>)	~30%	~14%	~70%	~33%	~47%
Us! (<i>Homo sapiens</i>)	>90%	~40%	<10%	<5%	~42-45%
Flatworm (<i>C. elegans</i>)	~5%	~0.5%	~95%	~11-12%	~12%
Fruit fly (<i>D. Melanogaster</i>)	<80%	~3%	>20%	~1%	~4%
Rice (e.g., <i>O. sativa</i>)	~15%	~1%	~85%	~5%	~6%

A summary of the classes and sub-types of transposable elements is compared to prokaryotic mobile elements in the table on the next page.

Types of Transposable Elements

Class	Type	Sub-Types	Basis of Mobility	Organismic Distribution (e.g.)	Examples	All, as % of Genome	Length (bp)	Genomic Location; Special Features			
PROKARYOTIC Mobile Elements	* DNA transposons	IS (Insertion Elements)	Cut-&-Paste	E. coli	IS1, IS2, IS3...	3%	1000-2000bp	Intergenic DNA; usually insertion-site specific			
		Composite Tn	Cut-&-Paste		Tn5		Source of antibiotic resistance genes				
		Complex Tn	Replicative, cointegrate formation		Mu		Can function as bacteriophage or transposon				
EUKARYOTIC Class II (DNA) transposons: ** Move via DNA intermediates	* DNA transposons	-----	Cut-&-Paste	D. melanogaster	P-element, Mariner	both = ~1%	1000-7000bp	Dispersed			
		-----	Cut-&-Paste	C. elegans.	Tc1 (Mariner)				~11-12%		
		-----		Z. maize	Ac, Ds					~40%	
		-----		H. Sapiens (human)	Mariner						~2-5%
EUKARYOTIC Class I (RNA) transposons: ** Move via RNA intermediates	* retro-transposons, retroposons	-----	Replicative, cointegrate formation	O. Sativa (rice) [Also plants, bacteria]	Miniature Inverted Repeat Transposable Elements (MITEs)	~6% (rice)	<500bp	Mostly associated with genes; transcribed into small RNAs			
		LTR retrotransposons	Reverse-transcription & integration (original copy not excised)	S. cerevisiae (yeast)	Ty				~3%	Up to 7000bp	Dispersed; (retrovirus-like, but no envelope protein genes)
		LINES (NON-LTR retrotransposons)	SINES (NON-LTR retrotransposons, or retroposons)	D. melanogaster	Copia						
		-----		H. Sapiens (human)	L1				~5%	~6000bp	Interspersed
-----	Z. maize	Cir-1	~45%								
-----	H. Sapiens (human)	Alu	~40%	80-400 bp							

- * In so-called **Cut-&-Paste** transposition, DNA transposons move from one location to another. In **Replicative** transposition, DNA transposons replicated a copy of the element that moves. **Retrotransposons** are active if their transcripts are translated so that appropriate enzymes can integrate their cDNA copies into genomic DNA.
- ** Many transposons are inactive, having been silenced by mutations or other factors. Active eukaryotic Class I or II transposons can be **autonomous** or **non-autonomous**. **Autonomous** transposons have all of the structural and functional features necessary for transposition (e.g., the maize **Ac** element). **Non-autonomous** transposons have all the structural features of autonomous transposons (e.g., inverted repeats and other DNA needed for transposition), except they lack or can't transcribe genes for enzymes required for mobility (e.g., the maize **Ds** element). Therefore, they can only transpose with the assistance of an actively transposing autonomous element that can provide the required enzymes.

The data in this table leads to the following conclusions:

- Transposon load is not correlated with evolutionary complexity of organisms.
- Transposons may be shared but have different evolutionary histories in different organisms.
- Where some transposons remain active, they have shaped and continue to shape genomic landscapes, especially in organisms with a high genomic proportion of transposons.

We will revisit some of these conclusions later, after looking at the structure and mechanism of mobility of different transposable elements.

1. *Eukaryotic DNA (Class II) Transposons*

Active eukaryotic DNA transposons share structural features with bacterial mobile elements, including flanking inverted repeats and genes required for transposition. Like bacterial elements, they leave a pair of flanking direct repeats of host cell DNA at the insertion site. The characteristic structure of a eukaryotic DNA transposon is shown below.

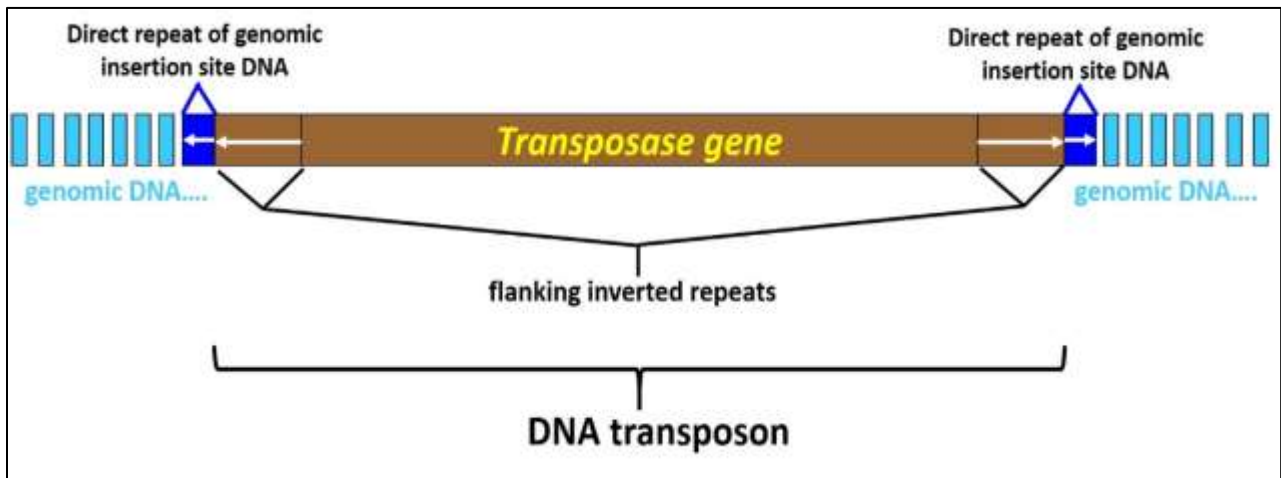

Class II transposons 'jump' either by a **cut-and paste** mechanism or a **replicative** mechanism. *Cut-and-paste* transposition removes a copy from an existing location and moves (*transposes*) it to another location. As its name suggests, *replicative* transposition leaves a copy of the original transposon in place while inserting a new copy elsewhere in the genome.

Transposition by the *cut-and-paste* mechanism is shown below.

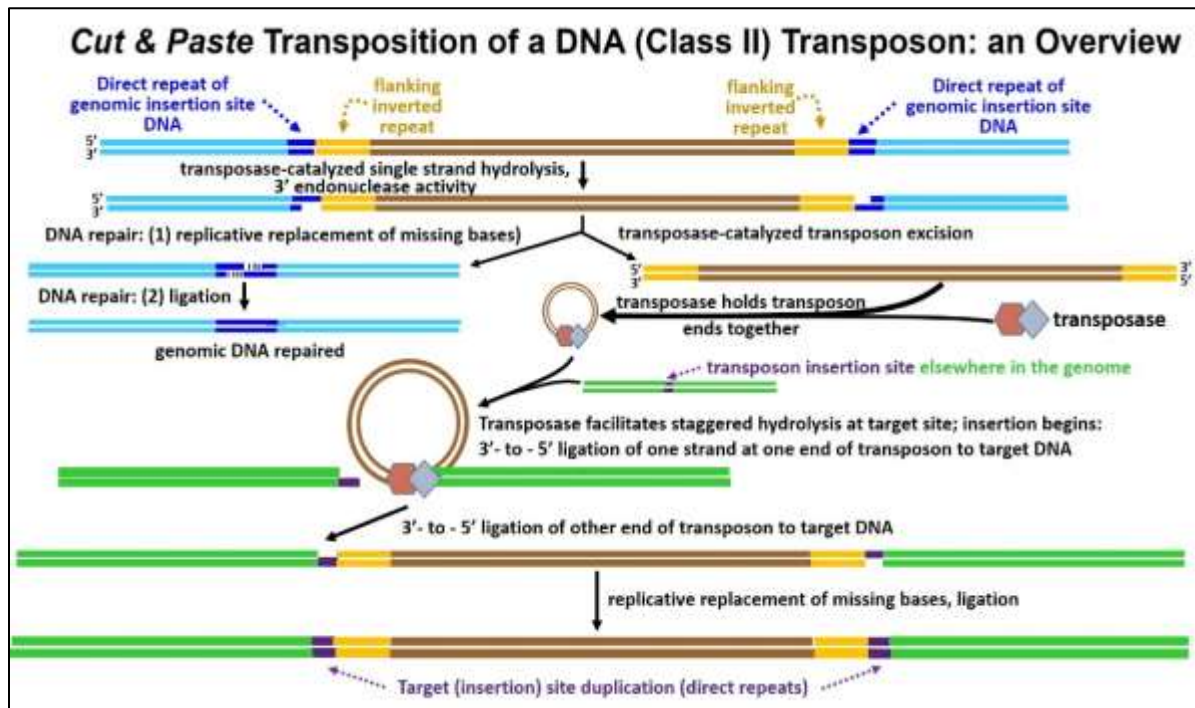

Note that after transcription of the transposase gene, the enzyme acts to nick the DNA and trim the 3'OH ends to create a staggered cut as the transposon is excised. The transposase actually brings the transposon ends together during the cut step and mediates its insertion at a new DNA site. After ligation of the 3'OH ends of the transposon to the 5'OH at the insertion site, the missing bases are replaced by replication and another ligation step. This generates the direct repeats of insertion site (i.e., host genomic) DNA.

In replicative transposition, the transposon also nicks and trims the DNA at its insertion site. But while holding the transposon ends together, the transposase activity catalyzes a hydrolytic attack of DNA at a new insertion site. This is followed by priming of replication of transposon strands from the 3'OH ends of the insertion site DNA strands. This process forms a **cointegrate** structure in which each transposon copy has been made by semi-conservative replication. One of two recombinational mechanisms then *resolves* the cointegrate. The result is copies of the transposon at both the original site and the new insertion site.

The replicative mechanism of transposition is summarized below.

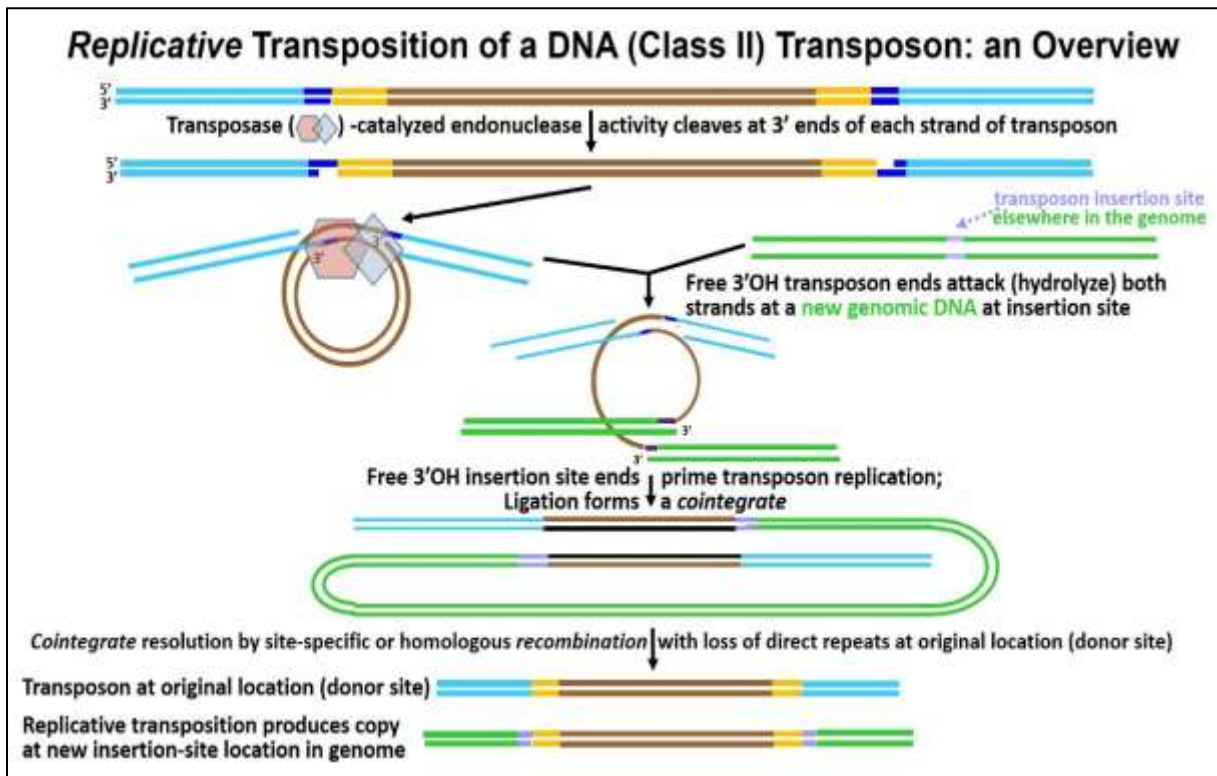

Let's compare and contrast the features of cut-&-paste and replicative DNA transposition. The **common features** are that:

- Transposon-encoded *transposase* binds, brings transposon ends together and catalyzes single-stranded cleavage (hydrolysis) leaving 'staggered ends'.
- Transposase continues to hold transposon ends together for the remaining steps.

The differences between the two mechanisms are that in *cut & paste* transposition, the transposon is completely excised and then transposed to a new site in genomic DNA. In contrast, after single stranded cleavage in replicative transposition, transposase-bound free 3' ends of transposon hydrolyze both strands of stranded DNA at a new insertion site. After ligation of the 3' ends of transposon strands to 5' ends of cut genomic DNA insertion-site ends, the remaining 3' ends of the insertion site DNA ends prime replication of the transposon, forming the *cointegrate*, which is followed by its resolution by one of two recombination pathways.

2. Eukaryotic RNA (Class I) Transposons

Active eukaryotic Class I transposons move via an RNA intermediate. They include **LTR retrotransposons** (such as the yeast **Ty** element) and **Non-LTR retrotransposons**. The Non-LTR retrotransposons include **LINES** (*Long Interspersed Nuclear Elements*) and **SINEs** (*Short Interspersed Nuclear Elements*). LTR retrotransposons and LINES contain one or more genes for transposition. Because SINEs lack enzymes necessary for transposition, they are sometimes called **retroposons** to distinguish them from retrotransposons that do contain such enzymes. SINEs are therefore *non-autonomous* transposons, relying on “true” retrotransposon activity for mobility. Like Class II elements, Class I transposons leave insert-site footprints, i.e., *direct repeats* of genomic DNA flanking the element.

LTR retrotransposons differ from other categories of retrotransposons by having long (>300bp) terminal repeat sequences flanking their gene(s). The typical yeast Ty element is shown below as it would exist integrated into cellular genomic DNA.

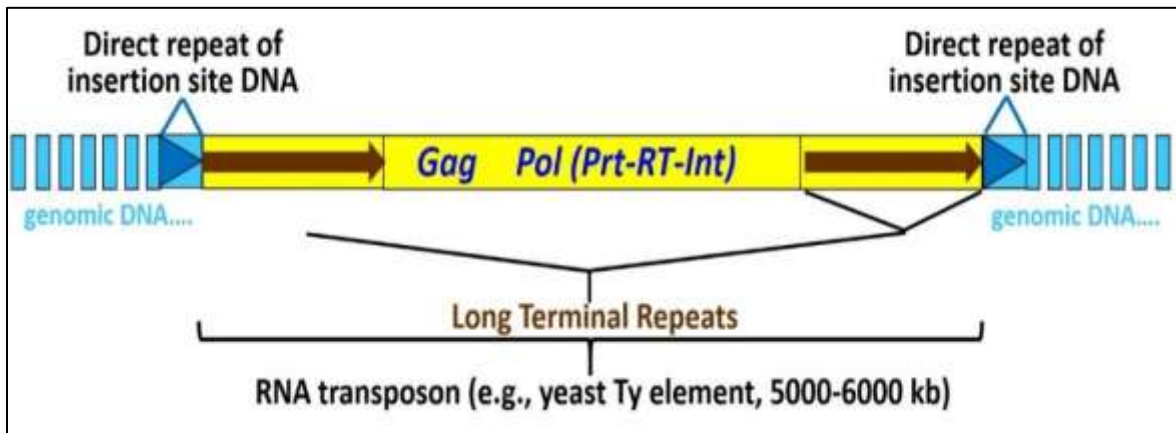

The Ty transposon harbors several genes needed for transposition:

- the **Gag** gene that encodes *group-specific antigen*, a protein that forms a virus-like particle that will contain reverse-transcribed transposon DNA,
- the **RT** gene that encodes the *reverse transcriptase* that will make reverse-transcribed copies of retrotransposon transcript RNAs.
- the **Prt** gene that encodes a protease that will break down the virus-like particle as the retrotransposon enters the nucleus.
- the **Int** gene that encodes the *integrase* required for integration of the retrotransposon into a genomic DNA insertion site.

Many of the events in Ty transposition occur in the cytoplasmic “virus-like particle” in yeast cells. To see more, click [Virus-Like Particles in Ty Transposition/Garfinke! Lab](#). Note that the Pol region in the illustration above consists of overlapping open reading frames (ORFs) encoding the Prt, RT and Int genes. The ready-to-move transposon consists only of the region of DNA symbolized in yellow.

While **LINES** encode enzymes needed for transposition and like other transposons, generate target-site direct repeats flanking the inserted element, do not have the long terminal repeats! Instead, their ORFs (genes) are flanked by 5' and a 3' **untranslated regions (UTRs)**, as shown in the drawing below of the human L1 LINE.

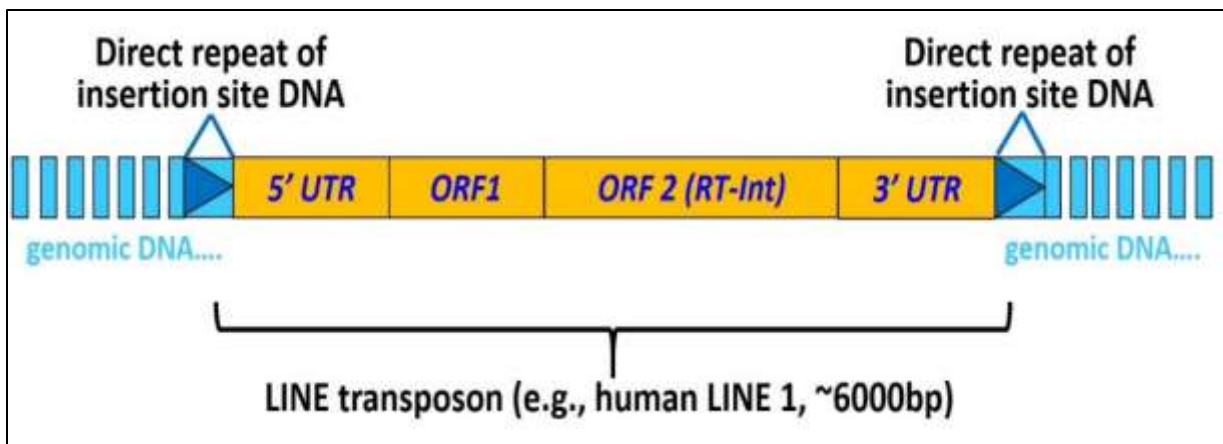

The 5' UTR contains a promoter from which cellular RNA polymerase II can transcribe the downstream genes (see the **Transcription** chapter). The second of these (ORF2) encodes the reverse transcriptase and an integrase activity essential for transposition of the LINE. All RNA-intermediate (Class I) autonomous transposons share the following features:

- **a Promoter** in the 5' UTR from which they can be transcribed
- **a Reverse Transcriptase** that generates a cDNA copy of the transposable element
- **RNAse H** (an endonuclease) that degrades the transcript after reverse transcription
- **Integrase** (like a transposase) that catalyzes insertion of the retrotransposon copy at insertion sites

Non-LTR SINE retrotransposons typically lack genes, but their non-genic DNA is nonetheless flanked by 5' and 3' UTRs. A typical SINE (e.g., the **Alu** element) is shown below.

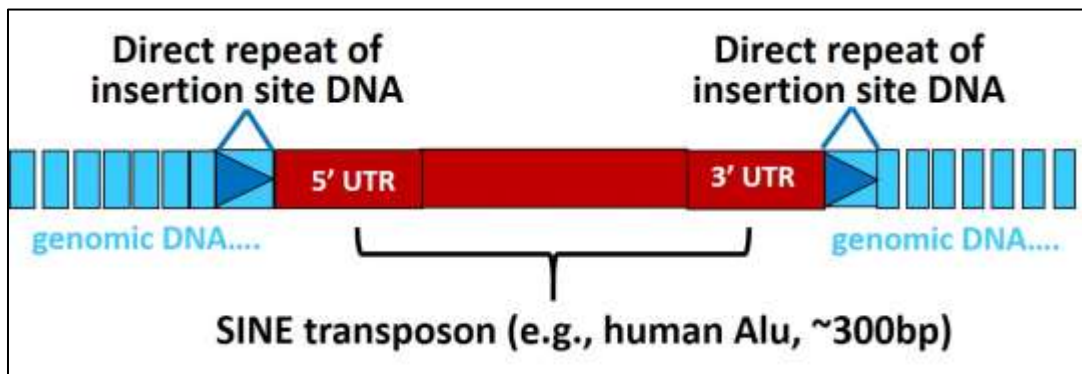

SINEs can be transcribed by RNA polymerase III, which also transcribes transfer RNAs (see the **Transcription** chapter). However, to transpose, they rely on the concurrent activity of a Non-LTR transposon (a LINE) to provide the requisite enzymatic activities. Two mechanisms of retrotransposition will be discussed shortly. An overview is shown in the following illustration.

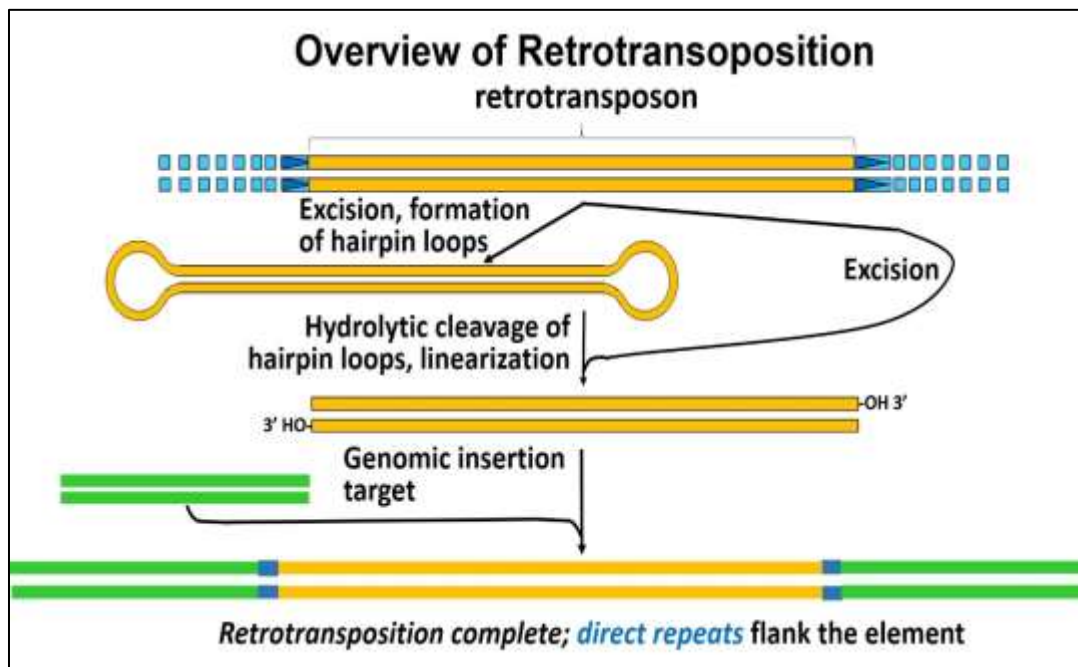

Hairpin loops at the ends of excised retro-elements will be hydrolyzed, and the 3' OH ends of the linearized transposon then attacks DNA at a new genomic insertion site. Insertion is accompanied by the generation of direct repeats on either end of the transposon.

The two mechanisms of retrotransposon discussed here are **Extrachromosomally Primed Retrotransposition** (LTR retrotransposons for example) and **Insertion Target-Site Primed Retrotransposition** (non-LTR Retrotransposons like LINEs and SINEs). The former is illustrated below.

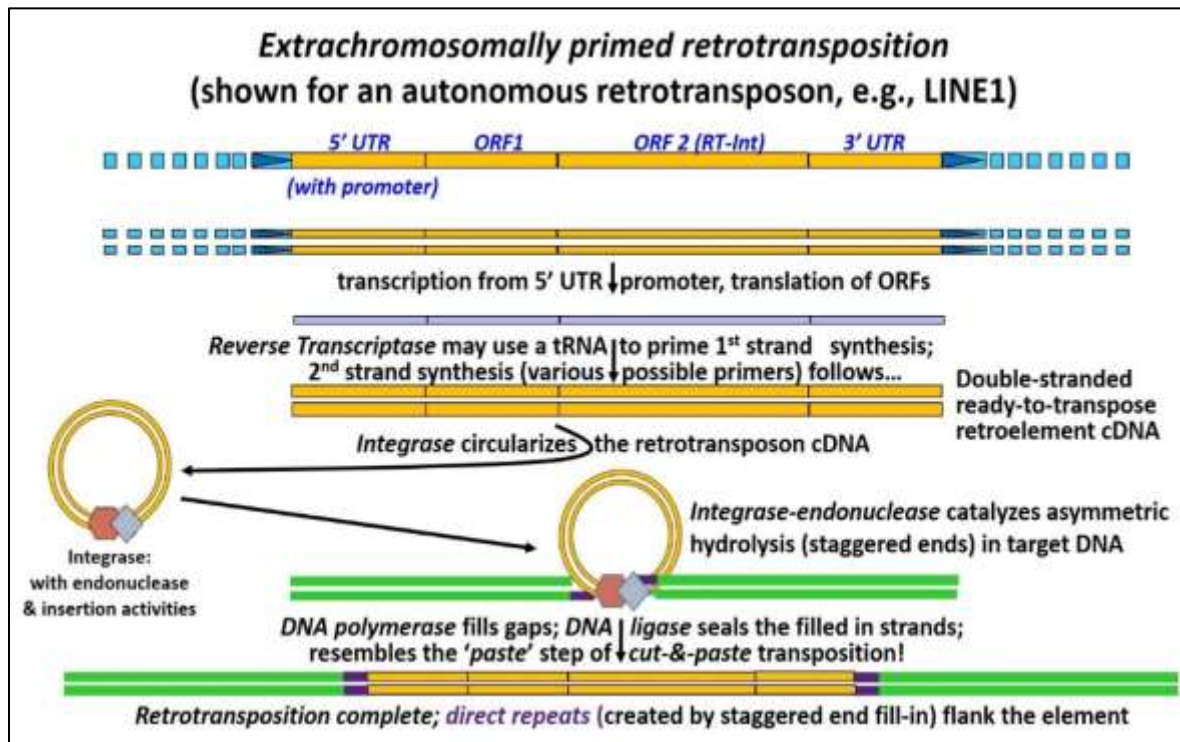

In this mechanism, reverse transcriptase creates a cDNA copy of a transcribed retro-element. Integrase/endonuclease then binds the cDNA copy, holding the ends together, in effect circularizing it. This isolable ribonucleoprotein resembles an **intasome**, similar to the nucleoprotein complex that catalyzes the integration of retroviral cDNAs during lysogeny. The 3-dimensional structure of a retroviral intasome interacting with DNA and nucleosomes was recently determined (for more, see Retroviral Intasome 3D Structure) In this form, the retrotransposon attacks DNA at an insertion site, creating staggered ends. After insertion, the gaps in the DNA are filled in. Ligation seals the retrotransposon in its new location, creating direct insertion site repeats.

Target-site primed retrotransposition (or *retroposition* according to some definitions) of a SINE is shown below.

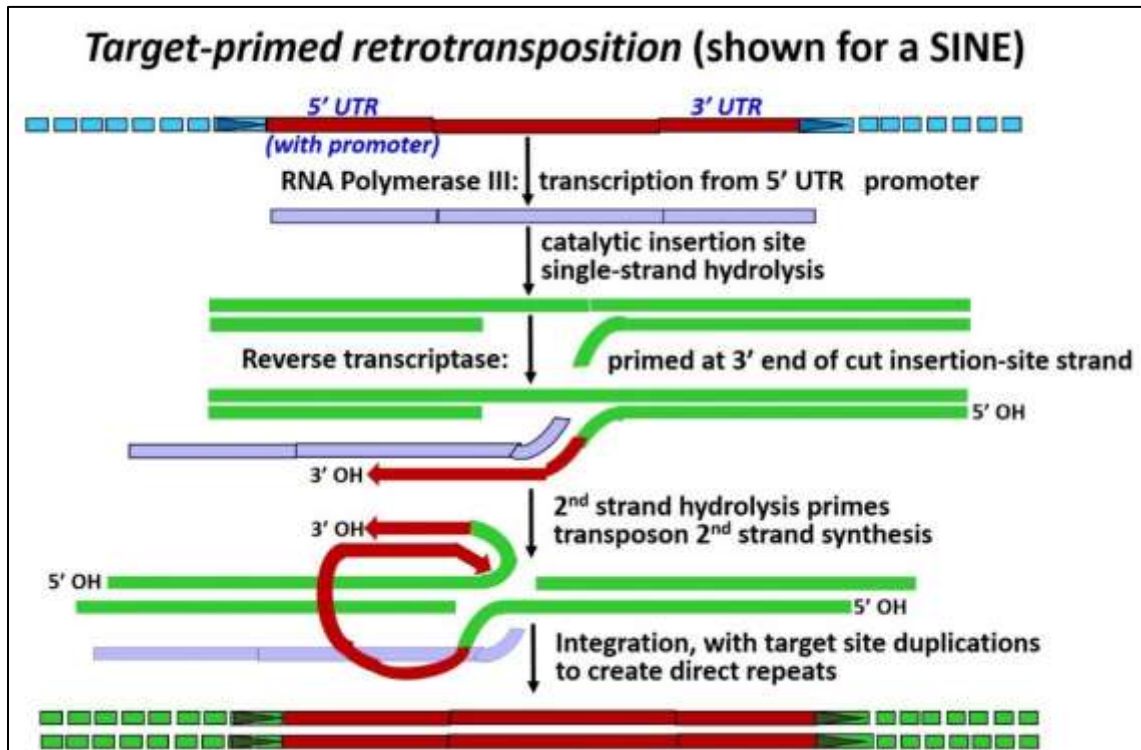

After SINE transcription by host cell RNA polymerase III (the enzyme that catalyzes tRNA and 5S rRNA transcription), the transcript can be reverse transcribed with the assistance of a reverse transcriptase encoded by a concurrently active LINE. However, a LINE-encoded integrase-endonuclease first catalyzes hydrolysis of one strand of DNA at an insertion site. The 3'OH end of this strand then primes reverse transcription of SINE transcript by the LINE reverse transcriptase. After hydrolysis of the second target site DNA strand, its 3'-OH end can prime replication of the second strand of the SINE cDNA. Integrase activity completes insertion of the copy-SINE in its new genomic DNA location.

V. On the Evolution of Transposons, Genes and Genomes

We've already noted that transposons in bacteria carry antibiotic resistance genes, a clear example of benefits of transposition in prokaryotes. Of course, prokaryotic genomes are small, as is the typical bacterial transposon load. But what of the high transposon load in eukaryotes?

Because genes encoding proteins typically represent only 1-2% of a eukaryotic genome, early notions were that much of the non-coding genome was non-essential. Since transposons were found interspersed all over this non-essential DNA, their persistence seemed to serve no function for the organism, and they were soon dubbed either junk or selfish DNA. Why do transposons exist? Are they just genomic baggage, *junk DNA*? And given their propensity to jump around raising havoc in genomes, how do we tolerate and survive them? Is their only 'mission' in fact, to reproduce themselves (are they merely *selfish genes*)? Since by their sheer proportions and activity in eukaryotic genomes, transposons can, and do re-shape the genomic landscapes. Does the consequent relocation and structural alteration and mutation of genes have any value, or do transposons serve no useful purpose in the organisms whose genomes they inhabit?

While all of these questions are a reasonable response to the phenomena of jumping genes, a rational hypothesis would be that, like all genetic change, transposons began by accident. But their spread and persistence in genomes of higher organisms must in the long term have been selected because they confer some benefit to their host genomes. Let's briefly look at the evolutionary history of transposons to see if this assumption has some merit.

A. A common ancestry of Class I and II transposons... and retroviruses

1. Class I and II transposons

Transposases catalyze cut-and-paste as well as replicative transposition of DNA transposons. *Integrases* catalyze insertion of reverse-transcribed retrotransposons. Bottom line: both enzymes end by catalyzing insertion of transposons into new DNA locations. So it should not be surprising that class I and II transposons enzymes share similar amino acid sequence and domain structures. The same is true for retrotransposon reverse transcriptases. These similarities support a common ancestry of class I and II transposons.

Sequence comparisons of transposable elements themselves reveal that they comprise distinct families of related elements. This allows us to speculate on the origins of these families in different species. For example, the TC1/*mariner* (DNA) transposon is found in virtually all organisms examined (except diatoms and green algae). Based on sequence analysis, there is even an insertion element in bacteria related to the *mariner* element. This amount and diversity of conservation bespeaks an early evolution of the enzymes of transposition, and of transposition itself. Furthermore, while linear descent (the 'vertical' transmission of transposons from parents to progeny) is the rule, the presence of some transposons in diverse species

is best explained by interspecific DNA (“horizontal”) transfer (discussed further below). Clearly, *moveable genes* have a part of life for a long time; their persistence in genomes speaks more to an adaptive value for organisms than to the parasitic action of rogue DNA!

2. *Retrovirus and LTR retrotransposon lifestyles reveal common ancestry*

The ‘integration’ domain of transposases also shares significant similarities with those of retroviruses, as shown below.

Comparison of Aligned Transposase and Integrase Sequences

Transposase ..W-D-TY-----HS**D**QGSQYTS--Y---L---G-I--S-S--G-S-DNA--**E**SP-G-LK-E...
Integrase ..W-D-TY-----/HS**D**QGPAP-S---Q-----G-I-H-TGIPYNPQSQG-V**E**R-N-TLK--...

The yeast Tn3 transposase and a consensus sequence of retroviral integrases share a conserved aspartate pair and one glutamate (shown in blue) known to come together during protein folding to form the **DDE** motif in the active site of the enzyme. These amino acids are surrounded by other highly conserved amino acids (in red). Slash = alignment gap

Several additional amino acids are conserved as alternates at several positions in this illustration (not shown).

The question that arises then, is whether transposons, specifically retrotransposons, arose as defective versions of integrated retrovirus DNA (i.e., reverse transcripts of retroviral RNA), or whether retroviruses emerged when retrotransposons evolved a way to leave their host cells. To better understand this question, let’s first consider the mechanisms of retrotransposition and retroviral propagation.

In addition to similarities of enzyme structure and activity between retrotransposons and retroviruses, LTR retrotransposons and retroviruses both contain flanking long terminal repeats. But retrotransposition occurs within the cell while retroviruses must infect host cells before they can integrate their genome into that of the infected cell. Unlike retrotransposons, retroviruses reproduce in the cell and release new viruses to the extracellular environment. A key structural difference between most retroviruses and retrotransposons is that retroviral DNA is surrounded by a protein envelope. This protein is encoded by the (ENV) gene. After infection, the envelope proteins of the

incoming retrovirus are shed and the viral RNA can be reverse transcribed. Transcription of necessary genes and replication of the viral cDNA leads to the production of new enveloped infectious viruses that will eventually lyse the infected cell.

But... here are two curious phenomena:

- Once integrated into the host cell genome, retroviral DNA, like any genomic DNA, is mutable. If a mutation inactivates one of the genes required for infection and retroviral release, it could become an LTR retrotransposon. When such a genetically damaged retroviral integrate is transcribed and then reverse-transcribed it can become an endogenous retrovirus (**ERV**). In fact, ERVs make up a substantial portion of the mammalian genome (8% in humans), where they do behave like LTR retrotransposons!
- During retrotransposition of the yeast TY element, the TY DNA is transcribed and its genes are transcribed. Among the proteins produced are not only reverse transcriptase and integrase, but also a protease, and a structural protein called **Gag** (*Group-specific antigen*). All of the translated proteins enter the nucleus. Mimicking the retroviral *ENV* protein, the Gag protein makes up most of a coat protein called **VLP (virus-like particle)** that encapsulates additional retrotransposon RNA in the cytoplasm, along with the other proteins. Double-stranded reverse transcripts (cDNAs) of the viral RNA are then made in the VLPs. But instead of bursting out of the cell, the encapsulated cDNAs ((i.e., new retrotransposons) shed their VLP coat and re-enter the nucleus... where it can now integrate into genomic target DNA. Compare this to the description of retroviral infection below.

During infection, retroviral envelope proteins attach to cell membranes and release their RNA into the cytoplasm. There the viral RNA is reverse transcribed into double-stranded (ds) cDNA copies of viral RNA that then enter the nucleus where they can integrate into host cell DNA. Transcription of the retroviral DNA can then produce transcripts that are translated in the cytoplasm into proteins necessary to form an infectious viral particle. The resulting viral RNAs are encapsulated by an ENV (envelope) protein encoded in the viral genome. Unlike the VLP-coated retrotransposon nucleic acids, the enveloped viral RNAs lyse the cell, releasing infectious particles. The VLP coated Ty elements are not infectious, but they sure resemble a retrovirus!

The common mechanisms of retrovirus and retrotransposon replication and integration clearly support their common ancestry, but do not indicate origins. On the one hand, the origin of ERVs from retroviruses might imply that retrotransposons arose in evolution from retroviruses. On the other, the fact that transposons have been around since the earliest prokaryotic cells, and that retrotransposons arose with eukaryotes might suggest that transposable elements in general were around before retroviruses.

Comparisons of aligned DNA sequences alignments permit phylogenetic analyses that reveal the evolutionary relationships of genes, in much the same way the evolutionary biologists once demonstrated evolutionary relationships comparing the morphological characteristics of organisms. Of course, tracing gene phylogenies reveals the phylogenetic relationships of organisms. Phylogenetic analyses based on comparisons of retroviral and retrotransposon reverse transcriptase genes support the evolution of retroviruses from transposon ancestors (shown below).

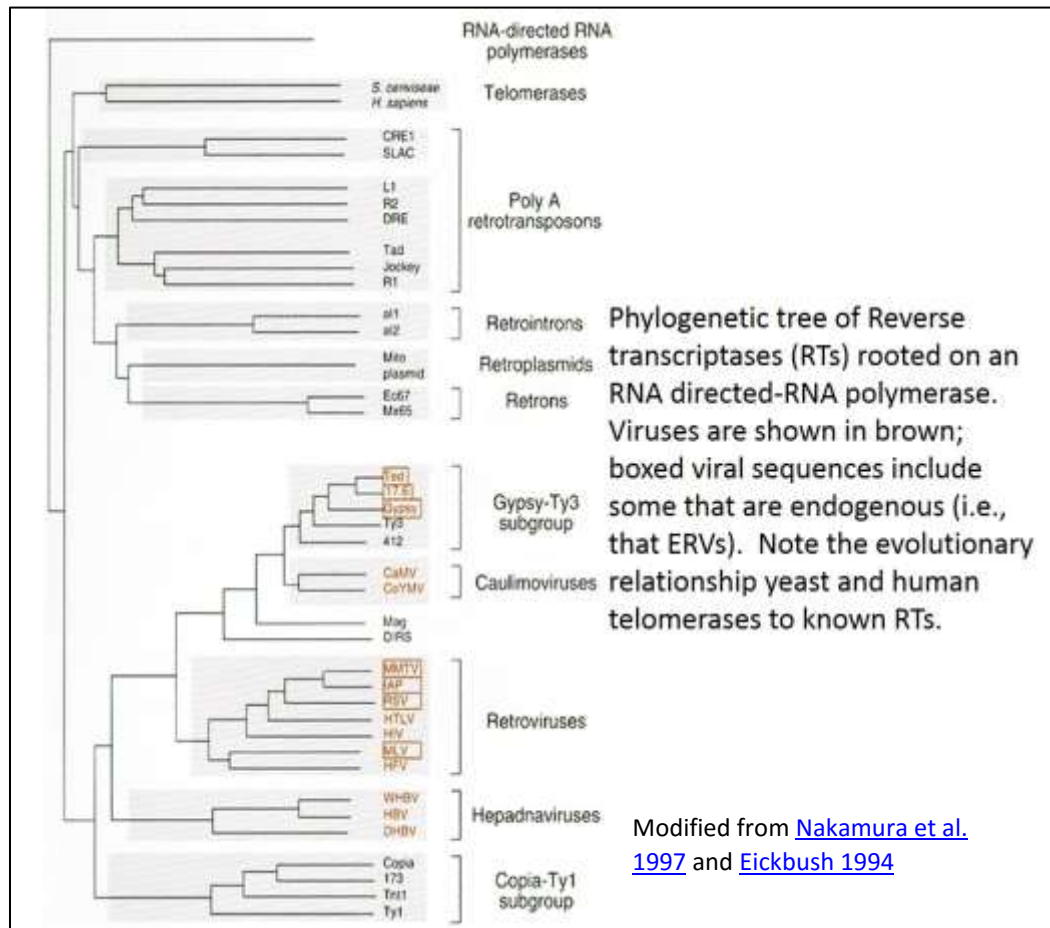

From the phylogenetic 'tree', it is clear that in the "Gypsi-TY3 subgroup", ERVs share common ancestry with several retrotransposons (e.g., TY3). Further, this sub-group shares common ancestry with more distantly related retroviruses (e.g., MMTV, HTLV...), as well as the even more distantly related (older, longer diverged!) Copia and TY1 transposon sub-group. This and similar analyses indicate that retroviruses evolved from a retrotransposon lineage [For a review of retroposon/retrovirus evolution, check out Lerat P. & Capy P. [1999, *Retrotransposons and retroviruses: analysis of the envelope gene*. Mol. Biol. Evol. 19(9): 1198-1207].

3. **Transposons can be acquired by "horizontal gene transfer"**

As noted, transposons are inherited **vertically**, just meaning that they are passed from cell to cell or parents to progeny by reproduction. But they may have spread *between* species by what is called **horizontal gene transfer**. This just means that organisms exposed to DNA containing transposons might inadvertently pick up such DNA and become *transformed* when the transposon becomes part of the genome. This accidental transfer of transposons would have been a rare occurrence. But the exchange of genes by horizontal gene transfer would have accelerated with the evolution of retroviruses. Once again, despite the potential to disrupt the health of individual organisms, retroviral activity might also have supported a genomic diversity useful to organisms.

4. **Activities that support the value of transposition to evolution**

Transposition may have fomented **exon shuffling**, (the introduction of novel exons into genes). **Exon shuffling** can confer a new domain and a new activity on the protein encoded by the transposed gene. For example, **Alu** (SINE) elements are often found within introns, where they can integrate with no ill effect. The similarity of Alu elements in the introns of unrelated genes can support *unequal crossing over between the different genes*, essentially moving an exon in one gene to a novel location in another gene. Another way in which transposons facilitate exon shuffling is more direct. Imagine a pair of transposons in introns of a gene on either side of an exon. If these transposons were to behave like the two outer IS elements in a *composite* transposon in bacteria (discussed above), they would be excised as a single large composite transposon that could then insert into an intron of a completely different gene! Some of these possibilities are illustrated in greater detail in Chapter 9.

Several eukaryotic genes seem to be derived from transposons based on sequence analyses. Perhaps the most intriguing example of this is found in the complex vertebrate *immune system*. Our immune system includes **immunoglobulins**, or **antibodies**. You inherited immunoglobulin genes from your parents. These genes contain multiple variant **V**, **D**, and **J** regions linked to a **C** region. **V**, **D**, **J** and **C** are defined as **V**ariable, **J**oining, **D**iversity and **C**onstant DNA regions. These regions will recombine to create many diverse V-D-J-C antibody molecules (the *D* region is not always included in the final recombined gene). This gene rearrangement occurs during the maturation of certain stem cells in bone marrow that will become immune cells (*B* or *T lymphocytes*). In response to a challenge by foreign substances called **antigens**, cells will be selected that contain **rearranged immunoglobulin genes** coding for immunoglobulins that can recognize and eliminate the invading antigens. A discussion of the molecular biology of the immune system is beyond our scope here. Suffice it to say that the recombinational pathway of immunoglobulin gene rearrangements includes enzymatic activities very similar to those of transposition. In fact, the so-called RAG1 enzyme of immunoglobulin gene rearrangement is closely related to a family of transposons (*transib*) found in invertebrates and fungi. Genes of the immune system seem to have their origins in a transposon!

5. Coping with the dangers of rampant transposition

Given the high proportion of a eukaryotic genome made up of transposable elements of one class or the other, and the general tendency of transposons to insert at random into new DNA loci, how come eukaryotic cells exist at all? Isn't the danger of transposition into essential gene sequences magnified by the possibility of multiple simultaneous transpositions of elements generated by replicative mechanisms? Indeed, transposons have been found in genes that are inactive as a result. An obvious explanation for our survival of transposon activity is that most transposition is into the >90% percent of the genome that doesn't code for proteins. Beyond this, the dangers of rampant transposition are mitigated by several known mechanisms that silence transposition once it has occurred. As long as transpositions are not lethal (e.g., because its integration inactivates a gene essential to life), the cell and organisms can survive the transposition. In time, mutations at the ends of the elements or in genes responsible for transposition (transposase, reverse transcriptase, integrase...) would render them inactive. There is also evidence of more immediate curb on transposition. Cells can recognize inappropriate transcripts by synthesizing a *small interfering RNA (siRNA)* that can complement unwanted transcripts and target them for destruction (see the Transcription chapter for more information on siRNAs).

Summing up, transposon activity may be moderated by general evolutionary loss of function and/or by more immediate mechanisms that ensure minimal activity, thus limiting genetic damage. Therefore transposons do not behave like, and nor are they

junk, or selfish DNA. Instead they increase genetic possibilities. By increasing options for the selection of new genotypes and phenotypic characteristics, transposons are part and parcel of the evolutionary diversity that sustains life on our planet.

Some iText & VOP Key Words and Terms

Alu	Gag	non-homologous recombination
anthocyanins	genomic complexity	Non-LTR transposons
antibiotic resistance genes	heterochromatin	protease
antibodies	immune system	protein coat
autonomous transposon	immunoglobulin genes	prt
bacterial composite transposons	integrase	renaturation kinetics
bacterial IS elements	inverted repeats	Repetitive DNA
bacterial Tn elements	jumping genes	replicative transposition
bacteriophage	L1	resolvase
centromere	LINE	retrotransposon
chromatin	LTR (long terminal repeats)	retrovirus
chromosomes	LTR transposons	RNA transposon
Class I transposon	lysis	satellite DNA
Class II transposon	lysogeny	SINE
cointegrate	lytic pathway of phage	spindle fibers
CoT curves	maize Ac (activator) gene	telomeres
cut-and-paste transposition	maize Ds (dissociator) gene	transposase
density gradient centrifugation	mariner	triploid endosperm
direct repeats	McClintock	Ty
DNA sequence phylogeny	mosaicism	viral infection
exon shuffling	Mu phage	
fertility (F) plasmids	non-autonomous transposon	

Chapter 10: Transcription and RNA Processing

RNA Transcription, RNA Polymerases, Initiation, Elongation, Termination, Processing

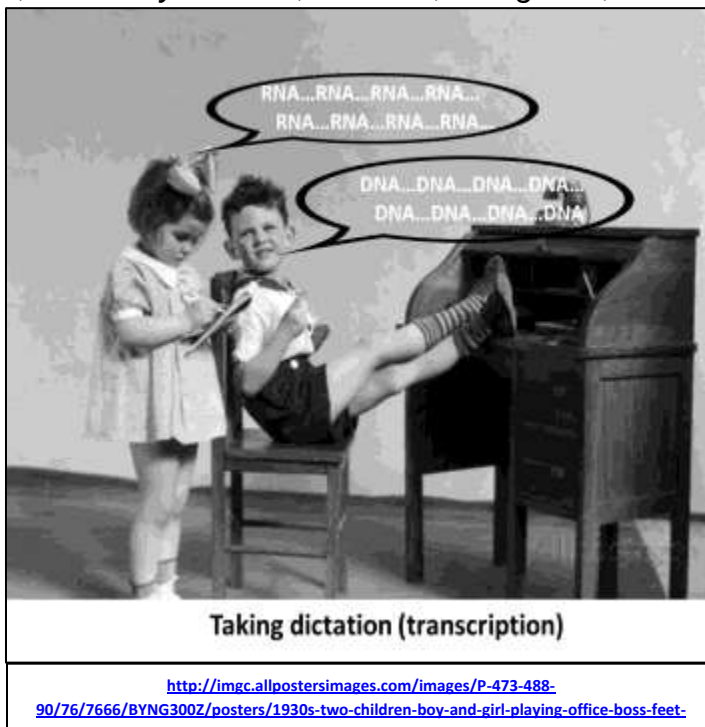

I. Introduction

Transcription, the synthesis of RNA based on a DNA template, is the central step of the *Central Dogma* proposed by Crick in 1958. The basic steps of transcription are the same as for replication: *initiation*, *elongation* and *termination*. The differences are in the details. For example, *E. coli* uses a single RNA polymerase enzyme to transcribe all kinds of RNAs while eukaryotic cells use different RNA polymerases for ribosomal RNA (*rRNA*), transfer RNA (*tRNA*) and messenger RNA (*mRNA*) synthesis. Recalling that bacterial DNA is almost 'naked' while eukaryotic DNA is in a nucleus all wrapped up in chromatin proteins, you might guess that RNA polymerases and other transcription proteins need help accessing DNA in higher organisms. Another difference is that most RNA transcripts in prokaryotes emerge from transcription ready to use. Eukaryotic transcripts are typically synthesized as longer precursors that must be *processed* by *trimming* or *splicing* (or both!). Another difference: in bacterial cells translation of an mRNA can begin even before the transcript is finished. That's because these cells have no nucleus. In our cells, RNAs must exit the nucleus before they are used to make proteins on *ribosomes* in the cytoplasm. In this chapter, you will encounter

the *three major classes of RNA* and detailed mechanisms of their transcription and (in eukaryotes) their processing. You will also meet bacterial *polycistronic* mRNAs (mRNA transcripts of *operons* that encode more than one polypeptide). We'll introduce the structural basis of DNA-protein interactions, looking at the structural motifs and domains of nuclear proteins that are suited/fitted to recognizing and binding to sequences in double-stranded DNA.

Voice-Over PowerPoint Presentations

[RNA: Overview of Transcription](#)

[RNA: Transcription & Processing Part 1](#)

[RNA: Transcription & Processing Part 2](#)

Learning Objectives

When you have mastered the information in this chapter and the associated VOPs, you should be able to:

1. discriminate between the *3 steps of transcription* in pro- and eukaryotes, and the *factors involved* in each
2. state an hypothesis for why eukaryotes evolved complex *RNA processing* steps
3. speculate on why any cell in its right mind would have genes containing *introns* and *exons* so that their transcripts would have to be processed by *splicing*
4. articulate the differences between *RNA vs. DNA structure*
5. explain the need for *sigma factors* in bacteria
6. speculate on *why eukaryotes do not have operons*
7. list structural features of proteins that bind and *recognize specific DNA sequences*
8. explain how proteins that *do not* bind specific DNA sequences *can* still bind to specific regions of the genome
9. formulate an hypothesis for why bacteria do not polyadenylate their mRNAs as much as eukaryotes do
10. formulate an hypothesis for why bacteria do not cap their mRNAs

II. Overview of Transcription

A. The Major Types of Cellular RNA

All cells make three main kinds of RNA: ribosomal RNA (***rRNA***), transfer RNA (***tRNA***) and messenger RNA (***mRNA***). *rRNA* is a structural as well as enzymatic component of ribosomes, the protein synthesizing machine of the cell. Quantitatively, rRNAs are by far the most abundant RNAs in the cell and mRNAs, the least.

Ribosomes are composed of a few rRNAs and 50 or more ribosomal proteins, as illustrated below.

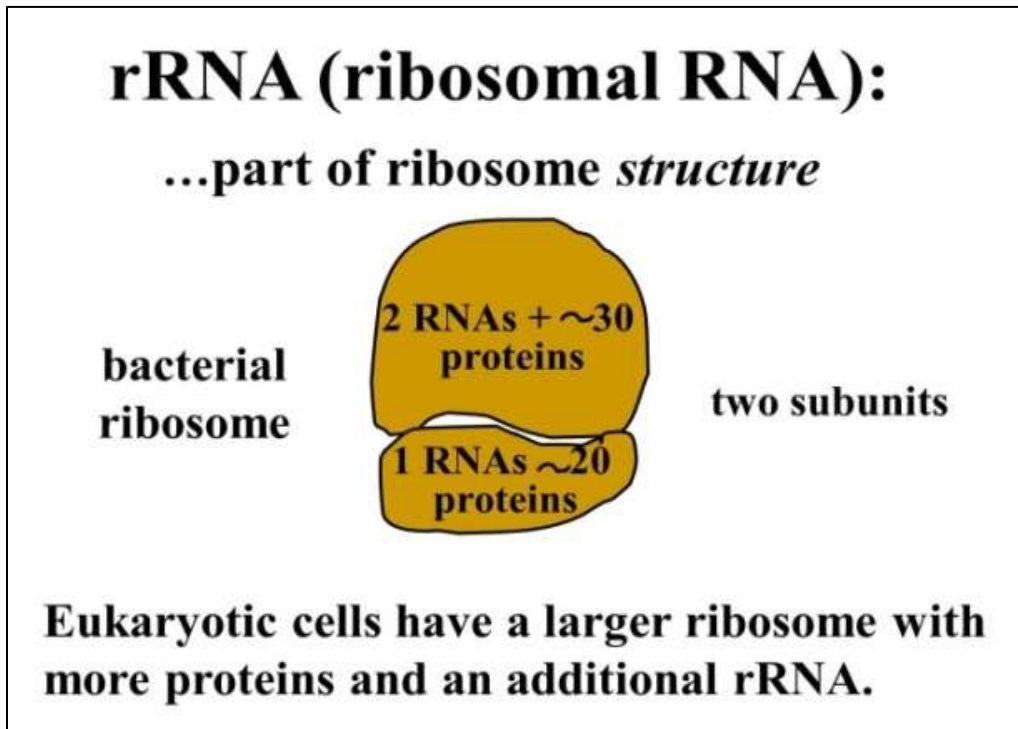

Transfer RNA (**tRNA**) is the informational decoding device used in protein synthesis (*translation*) to convert nucleic acid sequence information into amino acid sequences in polypeptides (summarized below).

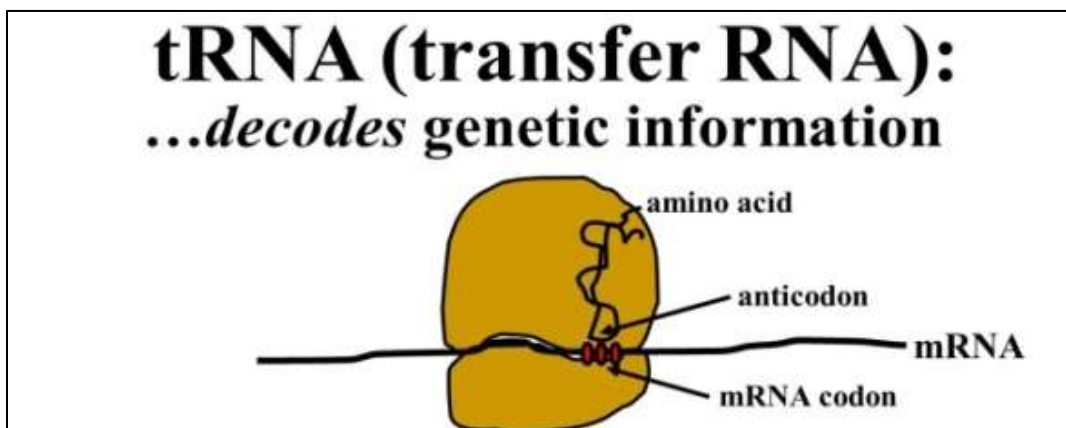

Messenger RNA (**mRNA**) contains the nucleic acid sequence that tRNAs decode on the ribosome into amino acid sequence. The existence of mRNA was expected because genetic information was inside the nucleus of eukaryotic cells, but the synthesis of polypeptides encoded by genes occurs in the cytoplasm. Of these 3 RNAs, mRNAs are the least abundant.

CHALLENGE: It turns out that mRNAs are not only a small proportion of cellular RNAs, but they are also unstable compared to rRNAs and tRNAs. Why do you think this is so?

The existence of mRNAs was eventually confirmed by Sidney Brenner. Check out Brenner's classic experiment [Brenner S (1961) *An unstable intermediate carrying information from genes to ribosomes for protein synthesis*. Nature 190:576-581].

Recall protein synthesis being translated by multiple ribosomes (associated as a polyribosome, or *polysome*), illustrated below.

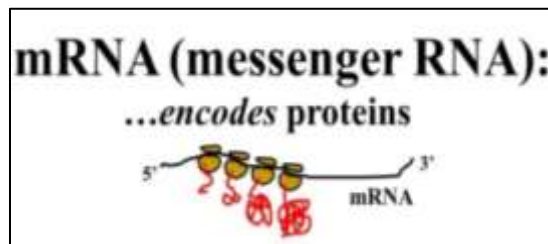

While mRNA is a small fraction of total cellular RNA, there are still smaller amounts of other RNAs such as the transient *primers* that we just saw in replication. We'll encounter still other kinds of RNAs later.

B. Key Steps of Transcription

In transcription, an *RNA polymerase* catalyzes synthesis of a complementary, antiparallel RNA strand. RNA polymerases use ribose nucleotide triphosphate (NTP) precursors, in contrast to DNA polymerases of replication which use *deoxyribose nucleotide* (dNTP) precursors. In addition, RNAs incorporate *uracil* (U) nucleotides into RNA strands instead of the thymine (T) nucleotides that end up in new DNA. Also in contrast to replication, RNA polymerases do not require a primer. With the help of transcription initiation factors, RNA polymerases recognize *transcription start sites* in genes and can start a new nucleic acid strand from scratch. Also, proofreading is less important during RNA synthesis.

While this means that there is a potential to make more mistakes during transcription than during replication, transcription errors are less consequential than those made during replication.

CHALLENGE: OK... so why are transcription errors... less consequential than those made during replication?

The basic steps of transcription are summarized below:

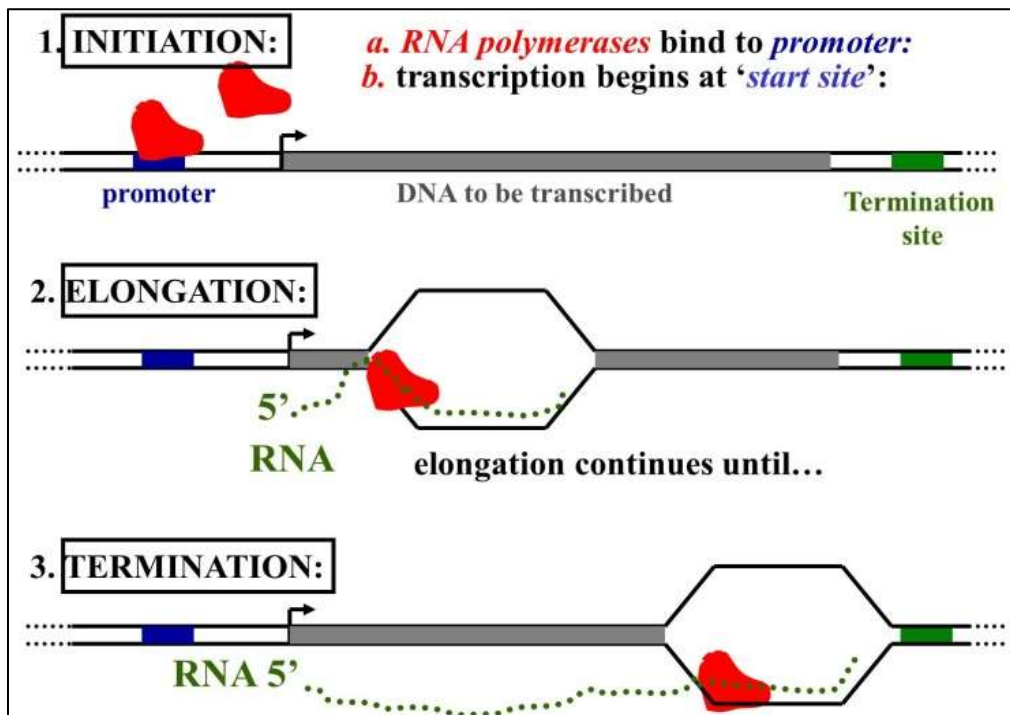

Here we can identify several of the DNA sequences that characterize a gene. The *promoter* is the binding site for RNA polymerase. It usually lies 5' to, or *upstream* of the transcription start site (the bent arrow). Binding of the RNA polymerase positions the enzyme to start unwinding the double helix near the transcription start site and to begin synthesizing new RNA from that site. The grey regions in the 3 panels are the regions of DNA that will be transcribed. Termination sites are typically 3' to, or *downstream* from the transcribed region of the gene. Note that by convention, *upstream* refers to DNA to the left of (5' to) the transcription unit (i.e., start site) of a gene, while *downstream* refers to DNA to the right of (3' to) the 3' end of the transcription unit.

In bacteria, some transcription units encode more than one kind of RNA. Bacterial *operons* are an example of this phenomenon, in which a single mRNA molecule contains mRNA regions that are translated into more than one polypeptide (shown below).

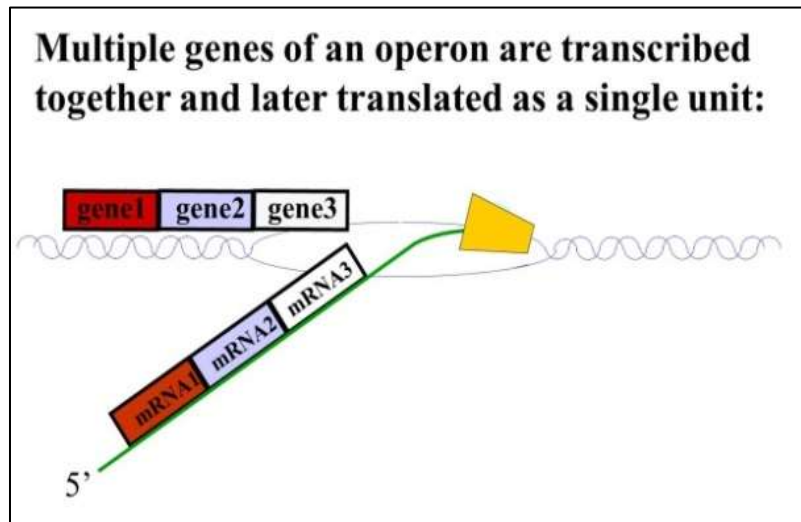

CHALLENGE: Why do you think some genes are organized into operons in bacterial cells, and why might eukaryotes lack (or lost) this form of gene organization?

C. RNAs are Extensively Processed After Transcription in Eukaryotes

Transcription is the basic mechanism of gene expression. The DNA region that is actually transcribed is a *transcription unit*. Transcription units include genes for *messenger RNA (mRNA)* encoding polypeptides, *ribosomal RNA (rRNA)*, *transfer RNA (tRNA)* and a growing number of very short RNAs that help control the use of the other kinds of RNAs. While bacterial transcription of different RNAs requires only one RNA polymerase, the rRNAs, mRNAs and tRNAs are transcribed by different RNA polymerases. In 2006, Roger Kornberg received the Nobel Prize in Medicine for his discovery of the role of RNA polymerase II and other proteins in eukaryotic messenger RNA transcription (like father-like son!!)

Many eukaryotic RNAs are processed (trimmed and chemically modified) to mature functional RNAs from large precursor RNAs. These precursor RNAs (pre-RNAs, or primary transcripts) contain in their sequences the information necessary for their function in the cell.

Processing of the three major types of transcripts in eukaryotes is shown below.

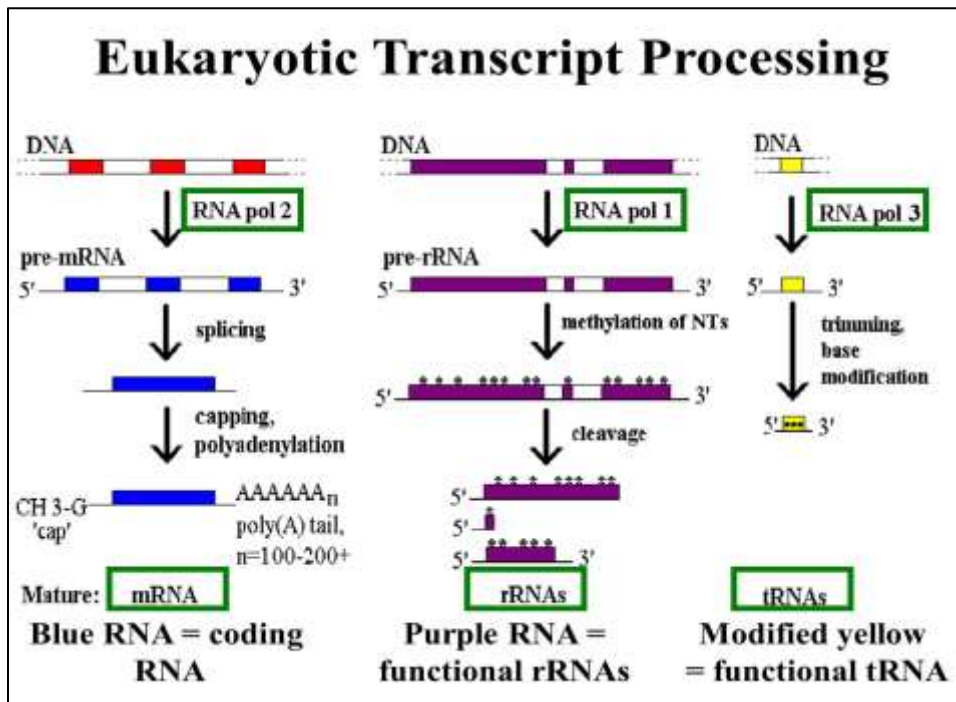

1. Primary mRNA transcripts are **spliced** to remove internal sequences called **introns** and to **ligate** the remaining coding regions of the message (called **exons**) into a continuous mRNA. In some cases, the same pre-mRNA can be transcribed into alternate mRNAs encoding related but not identical polypeptides!
2. Pre-ribosomal RNAs are cleaved and/or trimmed (not spliced!) to generate shorter functional rRNAs.
3. Pre-tRNAs are trimmed, some bases within the transcript are modified and 3 bases (not encoded by the tRNA gene) are enzymatically added to the 3'-end

We'll be looking at eukaryotic transcript processing in more detail later.

D. Transcription is Regulated: Genes Can be Turned On and Off

As we will see, transcription (*gene expression*) is controlled by the binding of *regulatory proteins* to DNA sequences associated with the gene. Most of these DNA *regulatory sequences* are relatively short and found *upstream* of the promoter in the 5'-nontranscribed DNA. In eukaryotes, transcriptional regulatory sequences are also found in the 3'-nontranscribed region of the gene, and even in introns (see below). Often these regulatory DNA elements are quite far from the transcription unit of the gene.

In another chapter we'll examine how regulatory proteins act to control transcription both near, and at a sometimes considerable distance from a gene. Here, let's consider briefly that all DNA binding proteins must get past chromatin protein guardians of the double helix. And even when they penetrate the chromatin protein covering, they encounter a highly electronegative phosphodiester backbone. So what is it that these proteins actually bind to? They "see" the base sequences in the interior of the double helix, mainly through the *major groove* and to a lesser extent, the *minor groove*. You can see how a bacterial regulatory protein with a *helix-turn-helix motif* binds to two consecutive turns of the major groove (below).

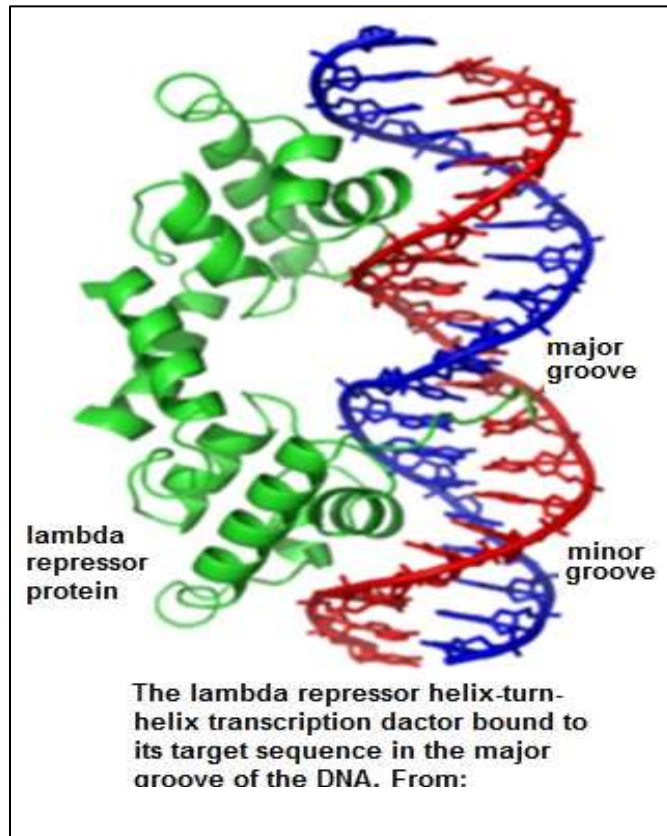

As always in macromolecular interactions, shape plays a major role! Regions of specific helices in the *lambda repressor protein* shown here are seen penetrating the major groove.

CHALLENGE: From the illustration, what do you notice about the location (or spacing, or position) of the DNA sequences that bind these helices?

III. Details of Transcription

A well written summary of transcription in prokaryotes and eukaryotes can be found in an NIH website at [Transcription in Prokaryotes and Eukaryotes](#). Here and at this link you will encounter proteins that bind DNA. Some do so just to allow transcription, like RNA polymerase and other proteins that must bind to the gene promoter to initiate transcription). Others, the regulatory factors (like the lambda repressor proteins we just saw) bind DNA to regulate transcription, *inducing* or *silencing* transcription of a gene. The details of transcription and processing differ substantially in prokaryotes and eukaryotes.

A. Prokaryotes

In *E. coli*, a single RNA polymerase transcribes all kinds of RNA. The RNA polymerase associates with a sigma factor (σ -factor). This is a protein that binds to the RNA polymerase to enable the enzyme to bind to the promoter sequence of a gene. The first promoter sequence to be defined was called the *Pribnow box* after its discoverer (illustrated below).

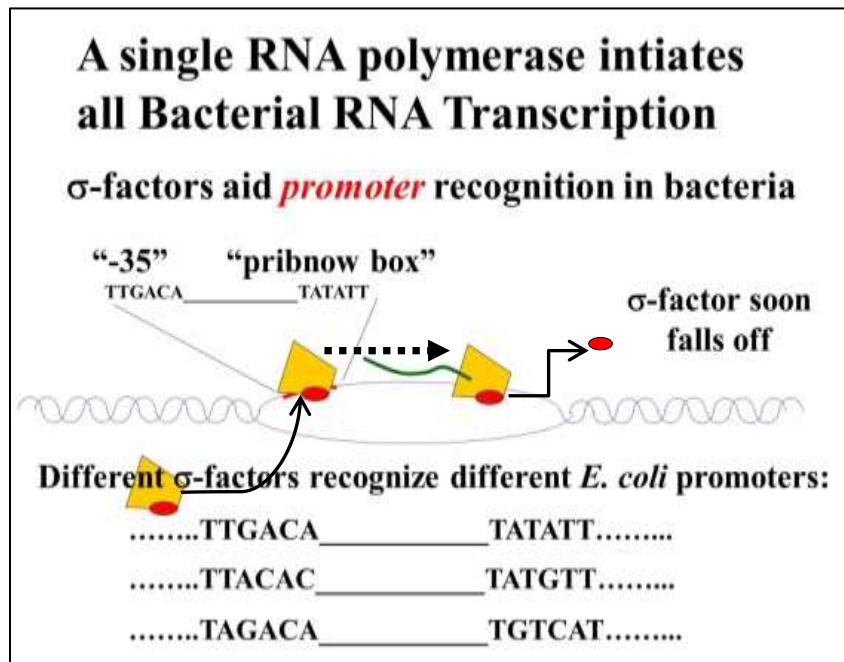

As shown, the bacterial genes can have one of several promoters, increasing options for when a gene is active. Thus, bacteria can regulate which genes are transcribed at a given moment by selectively controlling relative cellular concentrations of the different

sigma factors (σ -factors). A recent example may be *sigma 54*, a protein produced under stress (e.g., higher temperatures, antibiotic attack...). *Sigma 54* binds RNA polymerase, directing it to the promoters of genes that allow the bacterium to mount a defense against the stress (for more details, check out [Sigma 54 - a bacterial stress protein that alters transcription](#)). We shall see more modes of prokaryotic gene regulation in the next chapter. Soon after transcription is initiated, the σ -factors fall off the RNA polymerase which continues to unwind the double helix and to elongate the transcript. Elongation is the successive addition of nucleotides complementary to their DNA templates, forming phosphodiester linkages. The enzymatic reaction is similar to the DNA polymerase-catalyzed elongation of DNA during replication.

CHALLENGE: How does chain (strand) elongation during replication and transcription differ? Try a description in your own words.

There are two ways that bacterial RNA Polymerase ‘knows’ when it has reached the end of a transcription unit, neither of which relies on a protein binding to a defined sequence in DNA at the end of a gene! In one way, when the RNA polymerase nears the 3’ end of the nascent transcript, it transcribes a 72 base, C-rich region. At this point, a *termination factor* called the *rho* protein binds to the nascent RNA strand. *rho* is an ATP-dependent helicase that breaks H-bonds between the RNA and the template DNA strand, thus preventing further transcription. ***rho-dependent*** termination is illustrated below.

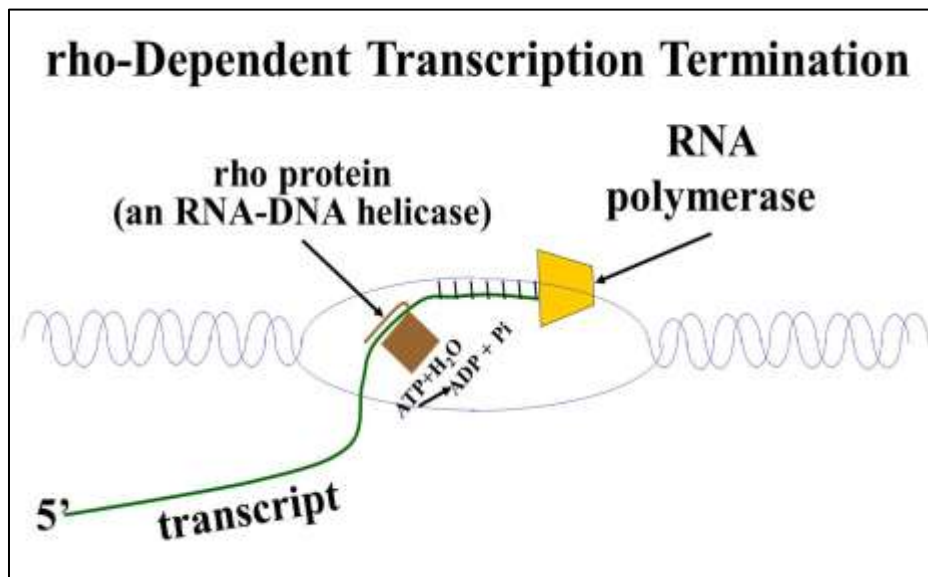

In the other mechanism of termination the polymerase transcribes RNA whose *termination signal* assumes a secondary structure that then causes the dissociation of the RNA Polymerase, template DNA and the new RNA transcript. This ***rho-independent termination*** is illustrated below.

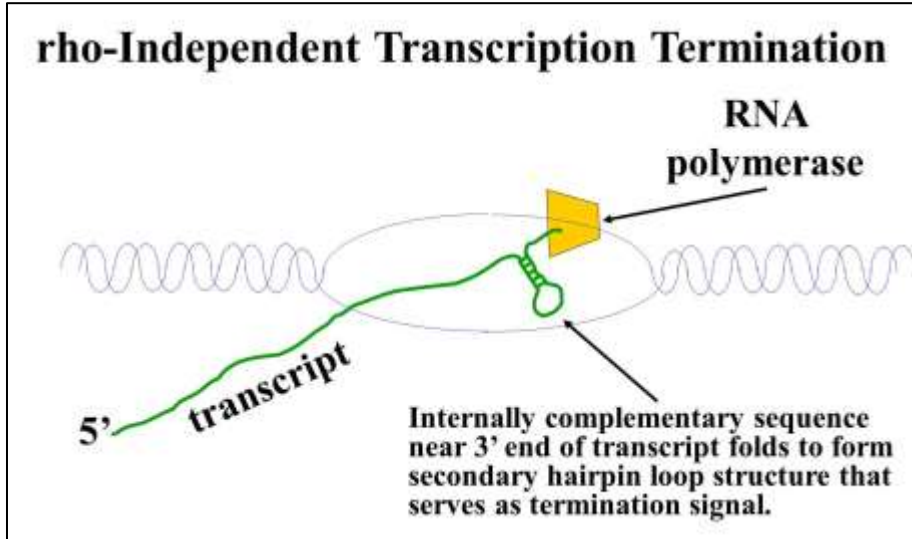

B. Eukaryotes

Whereas bacteria rely on a single RNA polymerase for their transcription needs, eukaryotes use 3 different enzymes to synthesize the three major different kinds of RNA, as shown below:

Prokaryotic Transcription		
<i>Catalyzed by a single RNA polymerase</i>		
Eukaryotic Transcription		
<i>Catalyzed by 3 different RNA polymerases:</i>		
<u>RNA pol I</u>	<u>RNA pol II</u>	<u>RNA pol III</u>
28S, 18S, 5.8S	mRNA	4S, 5S
rRNA		tRNA \ rRNA
(>90%)	(<5%)	(~5%)

Transcription of eukaryotic mRNAs by *RNA polymerase II* requires the sequential assembly of a eukaryotic *Initiation Complex* on the gene. This involves the interaction of many proteins with a promoter, summarized below.

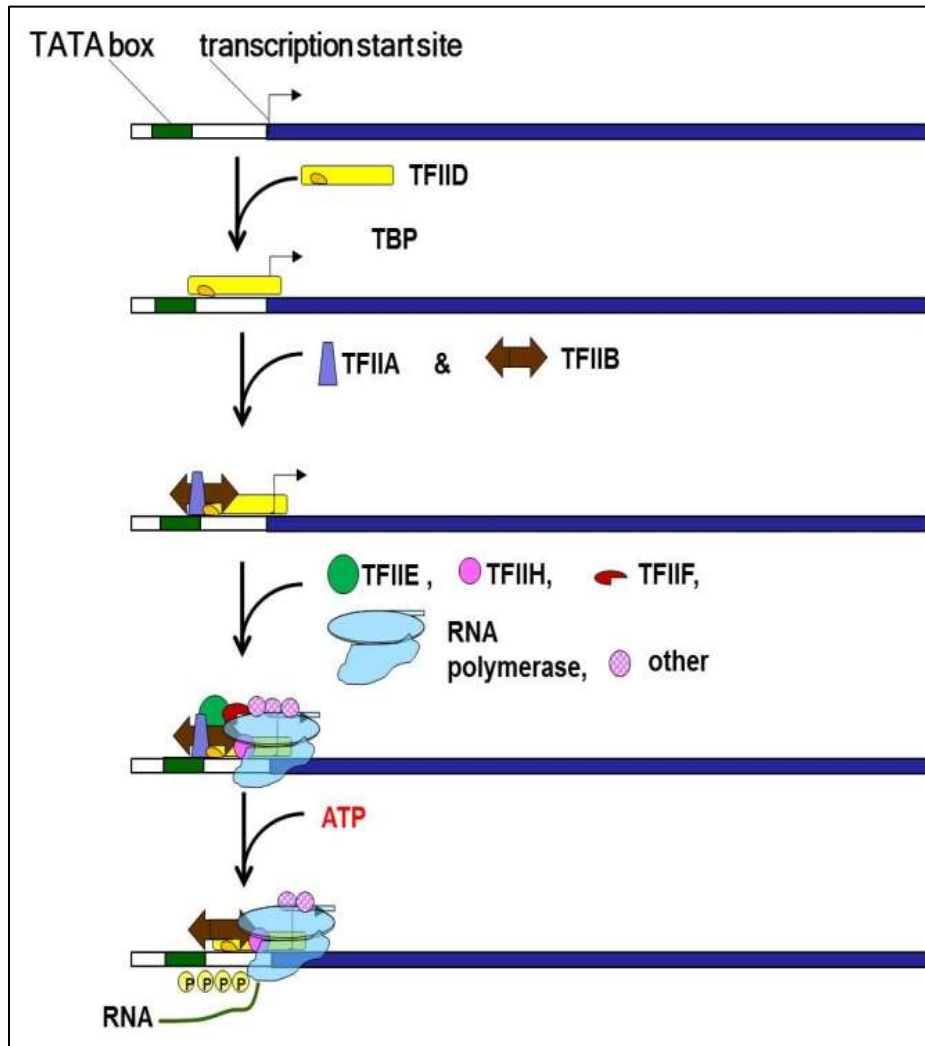

The typical eukaryotic promoter for a protein-encoding gene contains a TATA box DNA *sequence motif* as well as additional short upstream sequences. *TATA-binding protein (TBP)* first binds to the *TATA box* along with *TFIID (transcription initiation factor IID)*. This intermediate recruits *TFIIA* and *TFIIB*. Finally, *TFIIE*, *TFIIF* and *TFIIH*, several other initiation factors and finally *RNA polymerase II* bind to form a transcription *initiation complex*. The 5'-terminus of the RNA polymerase is then *phosphorylated* several times. After dissociation of some of the TF's the remaining RNA polymerase-TF complex starts elongation of the new RNA transcript.

Unlike prokaryotic RNA polymerase, eukaryotic RNA Polymerase II does not have an inherent helicase activity. For this, eukaryotic gene transcription relies on the multi-subunit TFIIF protein, in which two subunits have helicase activity. Consistent with the closer relationship of *archaea* and eukaryotes (rather than prokaryotes), transcription initiation in archaea and eukaryotes is similar, if somewhat less involved. The complex *is* assembled at a TATA-box, but its formation in archaea involves only RNA polymerase II, a TBP, and a TFIIF homologue called TFB.

Transcription of 5S rRNA and tRNAs by *RNA Polymerase III* is unusual in that the promoter sequence to which it binds (with the help of initiation factors) is not upstream of the transcribed sequence, but lies within the transcribed sequence (below top). After binding to this internal promoter, the polymerase re-positions itself to transcribe the RNA from the transcription start site (below middle). So, the final transcript contains the promoter sequence (below bottom). The 5S rRNA and all tRNAs are transcribed in this way by RNA polymerase III.

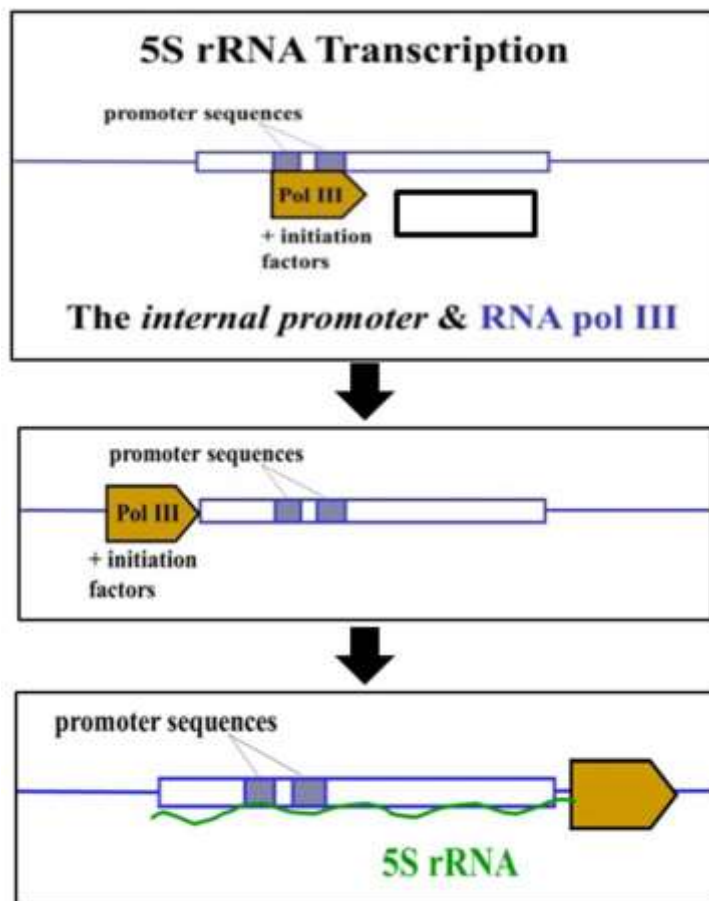

RNA Polymerase I and transcription initiation factors bind to rRNA gene promoters upstream of the transcribed region to begin their transcription, though less is known about the details of the process.

Likewise, transcription termination is not as well understood in eukaryotes as in prokaryotes. In the case of mRNA synthesis, termination is coupled to the polyadenylation processing step common to most mRNAs (discussed in more detail below). A useful summary of what is known is presented at this link from the NIH-NCBI website: [Eukaryotic RNA Polymerase Termination Mechanisms](#).

IV. Details of Eukaryotic RNA Processing

A. The Two Sources of Ribosomal RNAs

1. One source is a large gene that encodes a precursor transcript containing three size classes of rRNAs. From shortest to longest they are the 5.8S rRNA, 18SrRNA and 28S rRNA. The 'S' stands for Svedborg, the biochemist who developed the sedimentation velocity ultra-centrifugation technique that separates molecules like RNA by size. The higher the S value, the larger the molecule and therefore the faster it moves through the viscous sugar gradient during centrifugation. As shown in the illustration below, these rRNAs are transcribed by RNA Polymerase I from large transcription units.

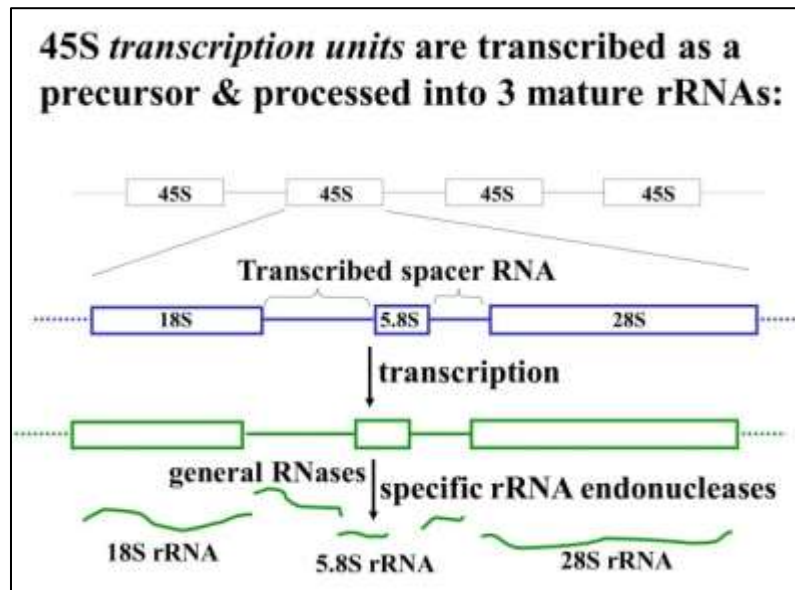

A 45S pre-rRNA transcript is then processed by cleavage. Actually, there are many copies of the 45S rRNA gene in eukaryotic cells, as might be expected since making proteins (and therefore ribosomes) will be an all-consuming cellular activity. The 45S rRNA genes are packed in the **nucleolus** inside nuclei. Because these genes are present in so many copies and organized into a specific region of chromatin, it is possible to visualize 45S transcription in progress in electron micrographs of *nucleolar* extracts. This was first done using amphibian cells (below).

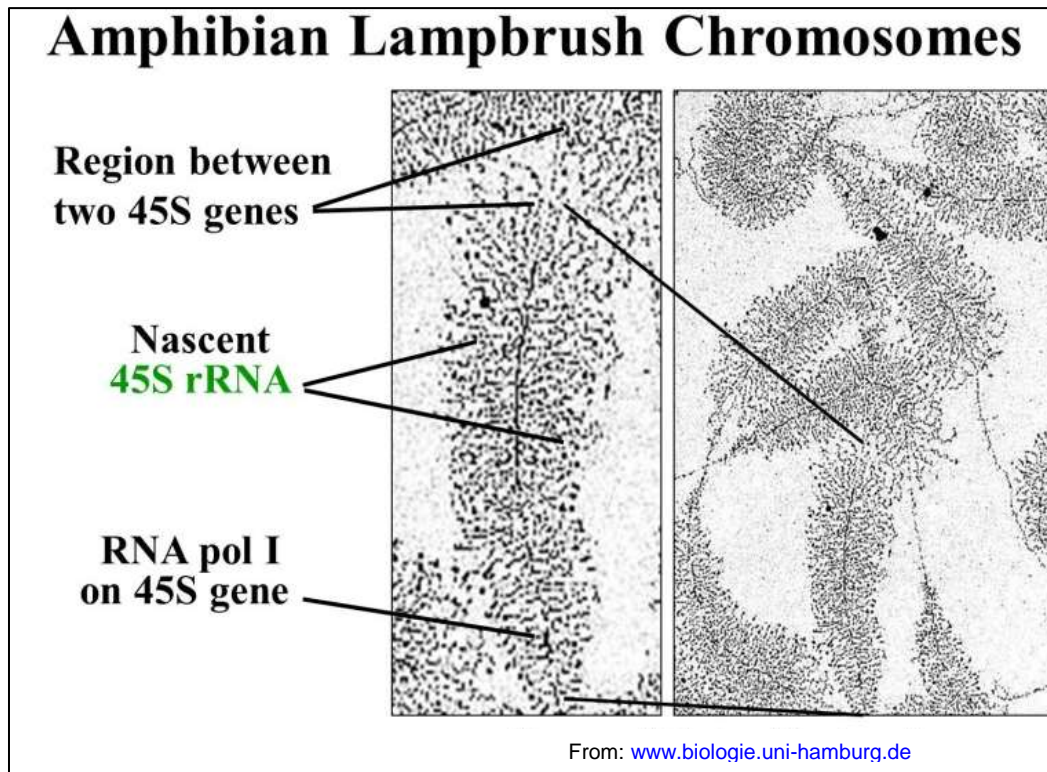

The term *lampbrush* came from the shape of the 45S regions being transcribed, in which RNAs extending from the DNA template look like the old fashioned brush used to clean the chimney of a kerosene lamp.

2. The other genetic source of rRNAs is the 5SrRNA gene, of which there are also multiple copies. Unlike the 45S rRNA genes clustered in the nucleolus, multiple copies of 5S rRNA genes are spread throughout the genome. The 5S gene transcript is the 5S rRNA. All of the 5S rRNA genes are transcribed by RNA polymerase III, without post-transcriptional significant processing. As already noted, the promoters of the 5S genes are within the transcribed part of the gene, rather than to the left of the genes.

B. tRNA Processing

Transcribed by RNA Polymerase III, tRNA genes have internal promoters, but unlike the 5S rRNA genes, tRNA genes tend to be clustered in the genome (below).

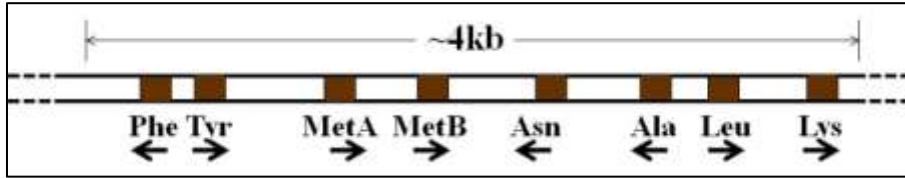

Their primary transcripts are processed by trimming, the enzymatic addition of a -C-C-A base triplet at the 3' end, and the modification of bases internal to the molecule, as illustrated below.

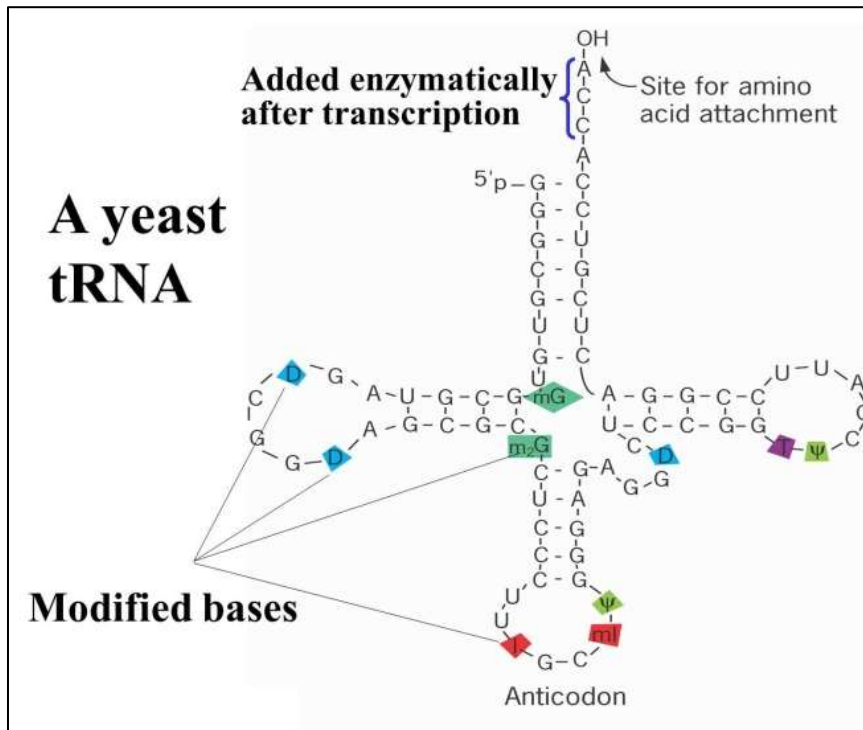

The 3'-terminal A residue of each tRNA will eventually bind to an amino acid specific for that tRNA.

CHALLENGE: So, what determines which amino acid binds to which tRNA?

C. mRNA Processing

The primary transcripts of eukaryotic mRNAs undergo the most extensive processing, including *splicing*, *capping* and, *polyadenylation*. Capping and polyadenylation were discovered first because their results could be easily seen in mRNAs isolated from the cytoplasm and nucleus. The processing steps described here are considered in order of occurrence.

1. Splicing

Bacterial genes contain a continuous coding region. Therefore, Richard J. Roberts' and Phillip A. Sharp's discovery of split genes in eukaryotes, with their introns and exons, came as quite a surprise. Not only would it seem incongruous for evolution to have stuck irrelevant DNA in the middle of coding DNA, no one could have dreamt up such a thing! For their work, Roberts and Sharp shared the Nobel Prize for Physiology in 1993.

Nevertheless, all but a few eukaryotic genes are split, and some have not one or two intervening sequences (the introns), but as many as 30-50 of them! The illustration below summarizes the splicing process:

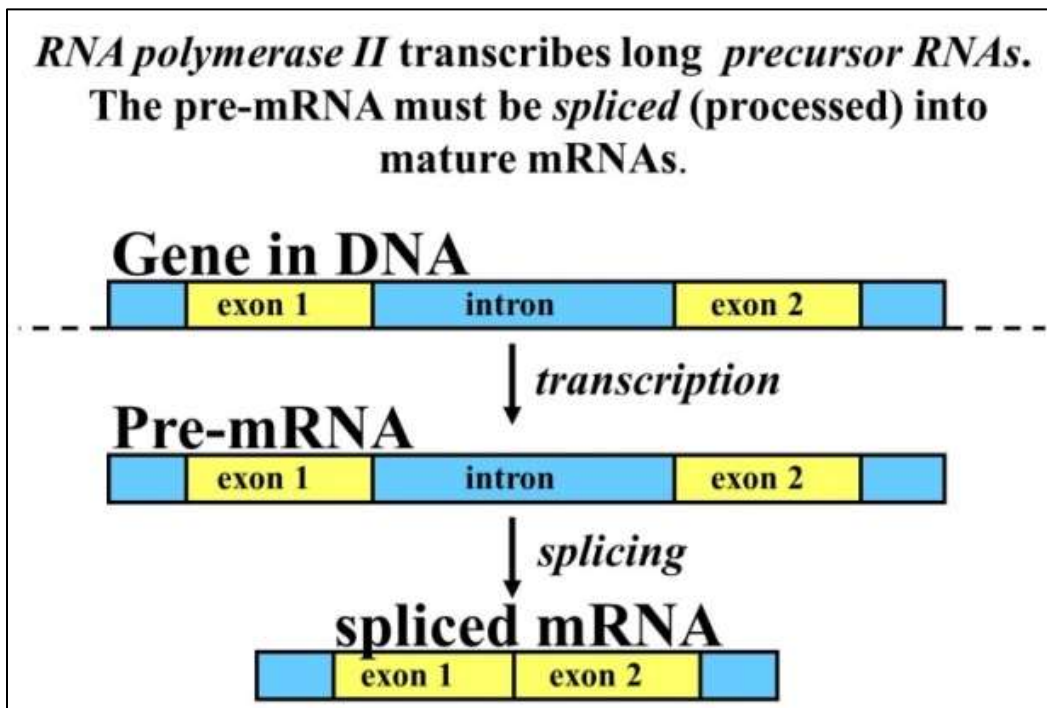

Splicing involves a number of *small ribonuclear proteins (snRNPs)*. snRNPs, like ribosomal subunits, are a particle composed of both RNA and proteins required for their function. They bind to specific *splice sites* in an mRNA and then direct a sequential series of cuts and ligations (the splicing) necessary to process the mRNAs (illustrated below).

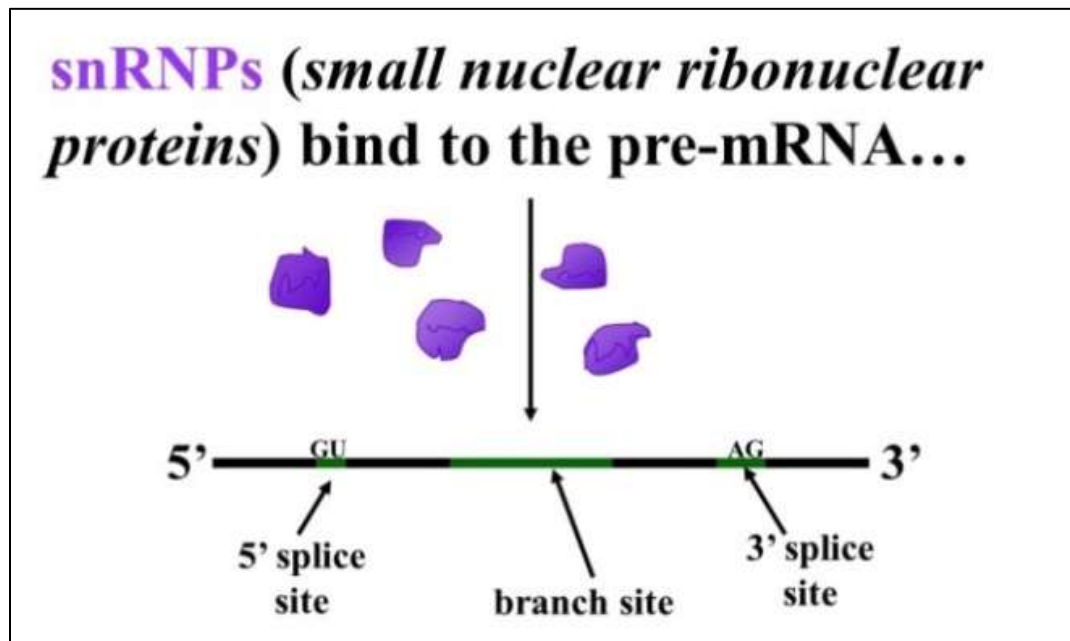

The binding of the snRNPs to the mRNA forms the *spliceosome* which completes the splicing, including removal of the *lariat* structure (the intron to be excised). The last step is to ligate exons into a continuous mRNA with all its codons intact and ready for translation. Spliceosome action is summarized below.

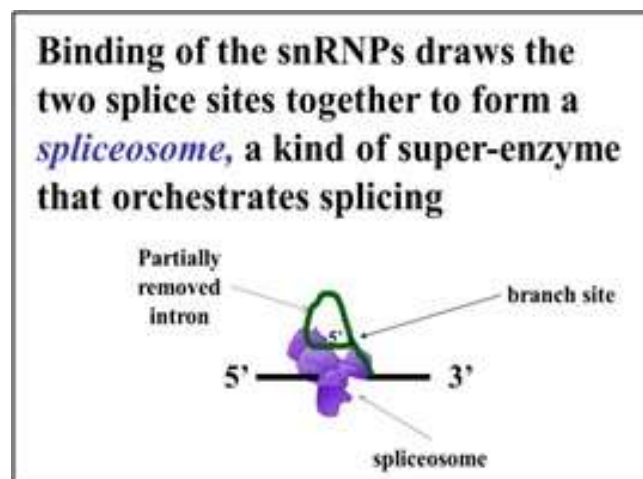

Click http://youtu.be/UN56se_yfY to see an animation of the order of interactions of snRNPs during mRNA splicing.

2. *Capping*

A capping enzyme places a methylated guanosine residue at the 5'-end of the mature mRNA, resulting in the structure illustrated below.

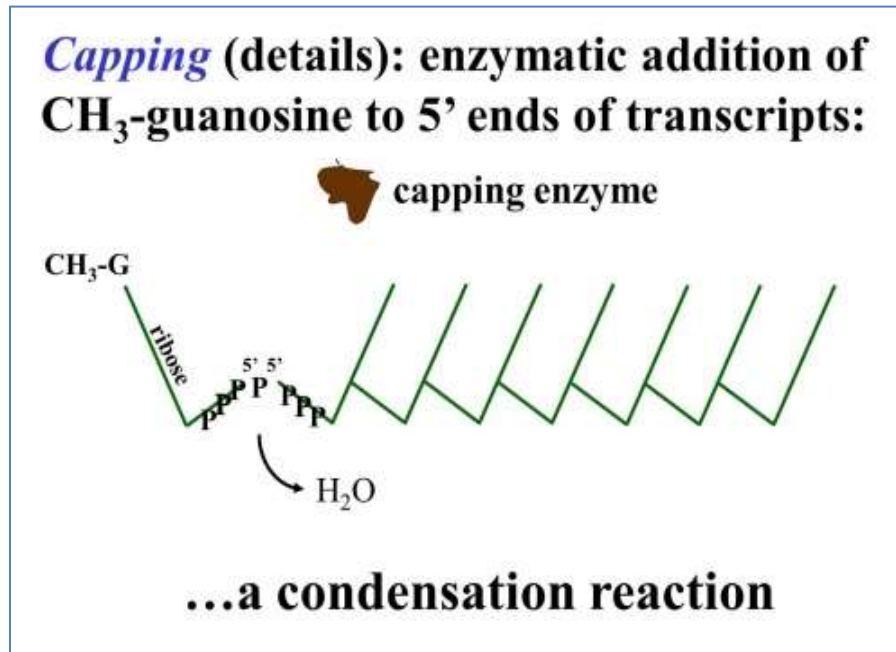

The check marks are nucleotides linked 5'-3'. The methyl guanosine cap is added 5'-to-5' and functions in part to help the mRNA leave the nucleus and then to associate with ribosomes during translation. This cap is typically added to an exposed 5' end even as transcription is still in progress but after splicing generates the 5' end of what will be the mature mRNA.

3. *Polyadenylation*

After transcription termination a series of AMP residues (several hundred in some cases) are added to the 3' terminus by an enzyme called *poly(A) polymerase*. The enzyme binds to an **AAUAA** sequence near the 3' end of an mRNA and begins to catalyze A addition. The result of this *polyadenylation* is a 3' *poly(A) tail* whose function includes regulating the mRNA half-life and assisting in transit of mRNAs from the nucleus to the

cytoplasm. The poly (A) tail shortens each time a ribosome completes translating the mRNA. The AAUAA poly(A) recognition site is indicated in red in the summary of polyadenylation shown below.

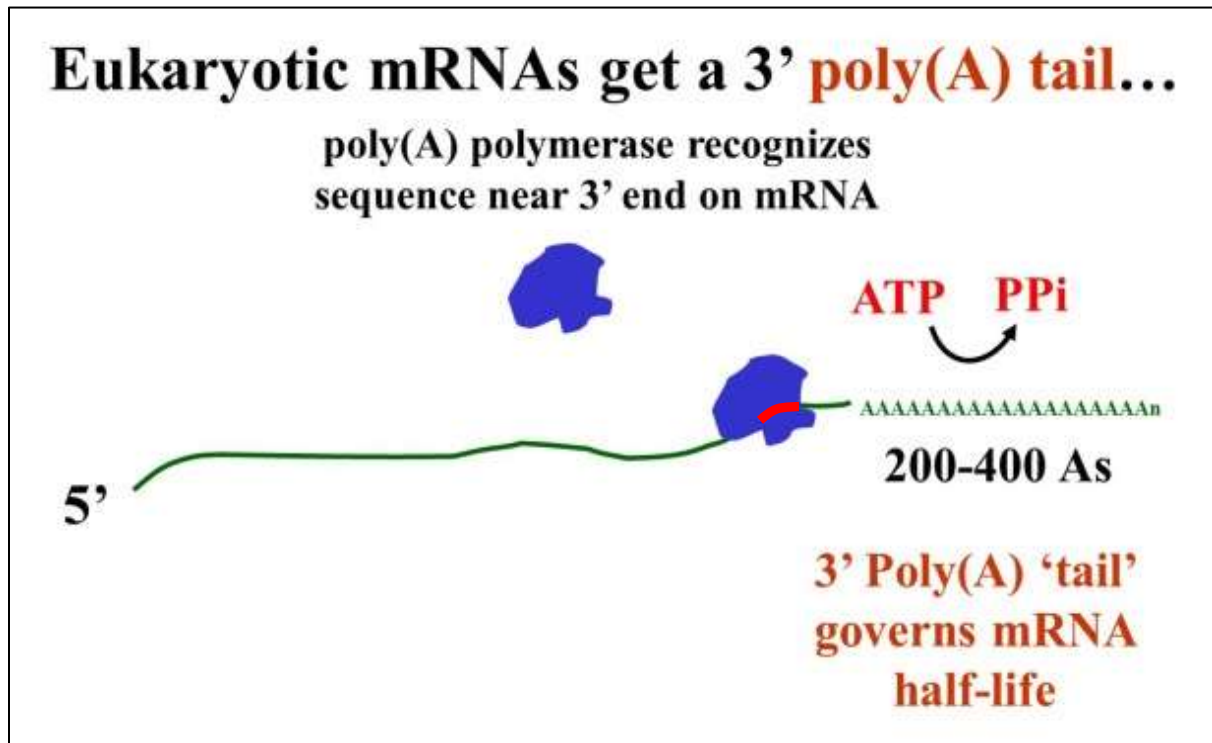

CHALLENGE: Bacterial mRNAs have been found with very short poly(A) tails. Would you expect poly(A) tails on bacterial mRNAs to function the same way they do in eukaryotic cells? Explain your expectation.

D. Why Splicing?

The puzzle implied by this question of course is why higher organisms have split genes in the first place. The answer may lie in the observation we made earlier about proteins with quite different functions overall sharing a domain and thus at least one function. Introns do not encode much genetic information, but they can be a large target for unequal crossing over between different genes.

Unequal crossing over targeting intronic DNA was surely one pathway for the phenomenon called **exon shuffling** (illustrated below).

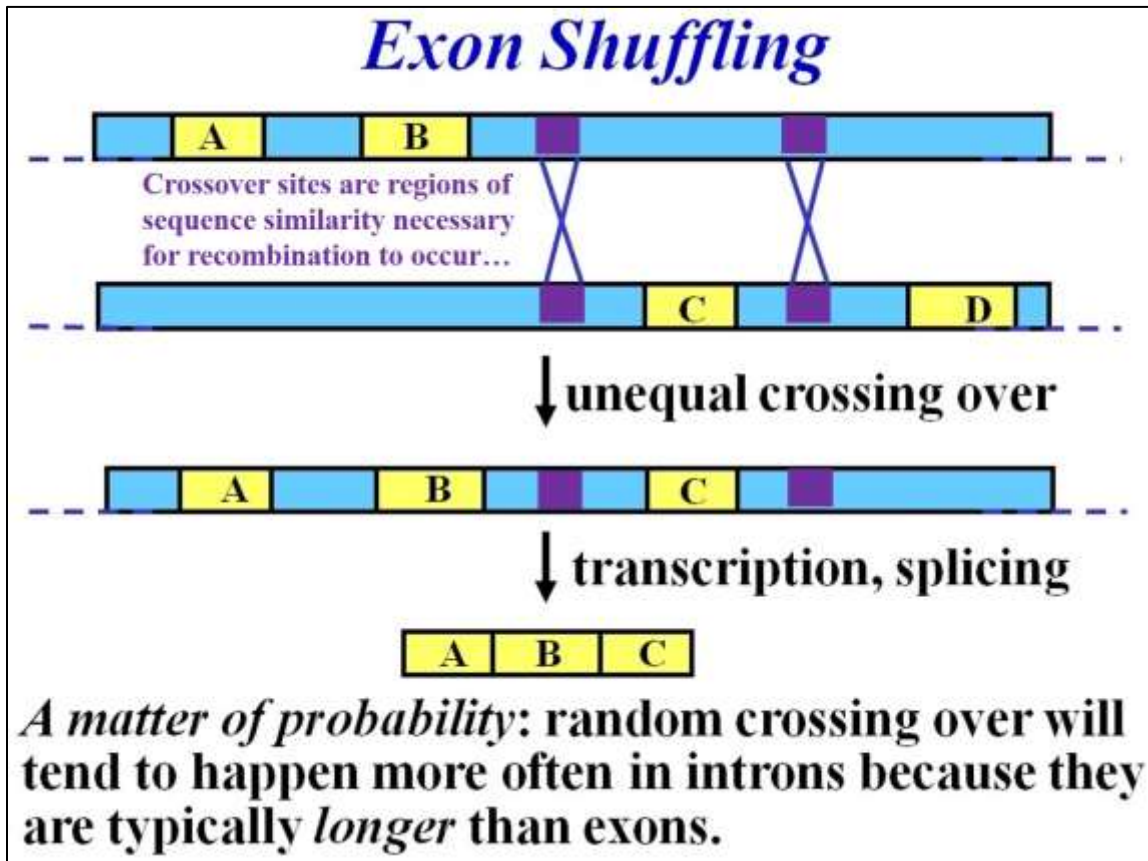

Recombination (equal or unequal) during meiosis depends on sequence similarities between the cross-over sites. Short sequence similarities are indeed dispersed in the genomic DNA, but H-bonding between DNA strands on nearby double helices during synapsis may not be strong enough to permit crossover. The presence of longer repeated DNA sequences would enhance prospects of unequal cross-over. Alu SINEs (shown in shown in purple in the illustration above) have frequently integrated into introns. These longer sequences could provide the necessary endurance of complementary pairing to allow a cross-over.

In another exon shuffling pathway, a pair of transposons in introns of a gene on either side of an exon can function in transposition like the pair of IS elements in a *composite* transposon in bacteria (discussed above). The result would be excision and transposition of the two transposons and the intron between them. If insertion occurred within the intron of another gene, this gene will have acquired a new exon.

The general pathway (involving DNA transposons) is illustrated below.

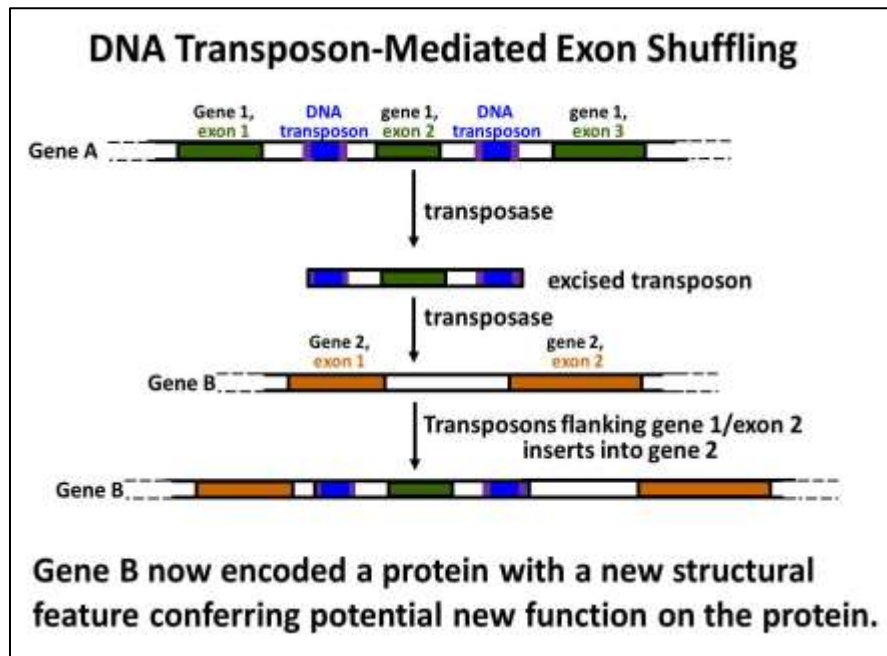

An example of transposon-mediated exon shuffling has been suggested for the insertion of *epidermal growth factor (EGF)* domains (exons) into several unrelated genes. EGF is a mitogenic factor that was discovered because it stimulated skin cells to start dividing. One gene that shares EGF domains is ***TPA*** (*tissue plasminogen activator*), a blood-clot dissolving *protease*. You may be familiar with TPA as a treatment for heart attack victims that, if administered rapidly after the attack, can dissolve the clot to allow coronary artery blood flow to heart muscle to resume. Other genes that contain EGF domains include Neu and Notch proteins, both involved in cellular differentiation and development. Other examples of exon shuffling may be mediated by LINE transposition as well as a special group of more recently discovered transposons called ***helitrons***. These transposons replicate by a *rolling circle* mechanism. If you are curious to know more about helitrons, do a google search to learn more about them, and what role they may have participated in refashioning and reconstructing genomes in evolution.

So, introns, are buffers against the possibility that random mutations would be deleterious, and they are potential targets for exon shuffling by several mechanisms. This makes introns key players in creating genetic diversity that is the hallmark of evolution.

E. RNA Export from the Nucleus

1. rRNA

The synthesis and processing of rRNAs is coincident with the assembly of the ribosomal subunits of which they are a part. The rRNAs initiate assembly and serve as a scaffold for the continued addition of ribosomal proteins to both the small and large ribosomal subunits. After the 5S rRNA is added to the large ribosomal subunit, processing of 45S rRNA is completed and the subunits are separated. The separated ribosomal subunits exit the nucleus to the cytoplasm where they will translate mRNAs into new proteins. The process is animated in this link: <http://youtu.be/jpHSgg1MIPg>. To better understand what's going on, try summarizing what you saw in the animation in the correct order of steps.

2. mRNA

As noted, the 5' methyl guanosine cap and the poly(A) tail collaborate to facilitate exit of mRNAs from the nucleus into the cytoplasm. We now understand that proteins in the nucleus participate in the export process. A **nuclear transport receptor** binds along the mature (or maturing) mRNA, a poly-A-binding protein binds along the mRNA poly-A tail of the message, and another protein binds at or near the methyl guanosine CAP itself. These interactions enable transport of the mRNA through nuclear pores. After the mRNA is in the cytoplasm, the nuclear transport receptor is re-cycled back into the nucleus while a *translation initiation factor* replaces the protein bound to the CAP. The nuclear transport process is summarized in the illustration below.

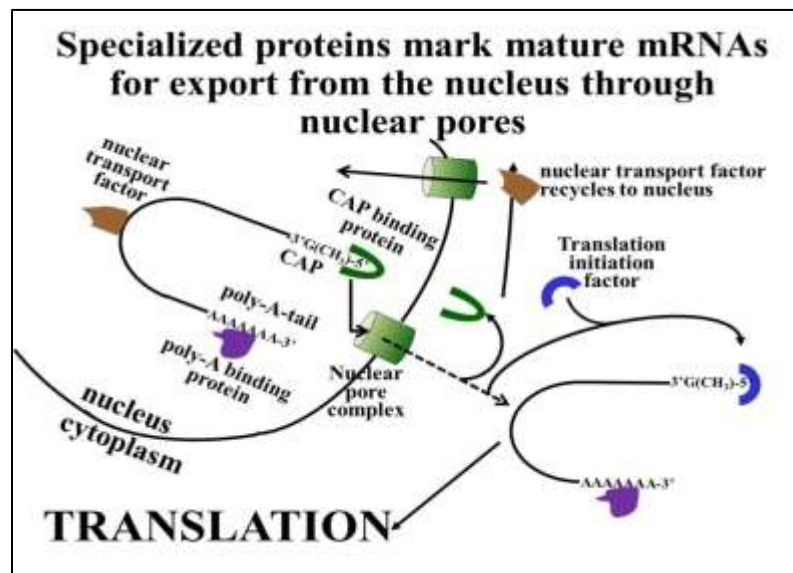

A more detailed description of mRNA transport from the nucleus is at this link: http://www.nature.com/nrm/journal/v8/n10/fig_tab/nrm2255_F1.html . The mature mRNA, now in the cytoplasm, is ready for translation. Translation is the process of protein synthesis mediated by ribosomes and a host of translation factors (including the initiation factor in the illustration. It is during translation that the genetic code is used to direct polypeptide synthesis. Details of translation are discussed in another chapter.

Some iText & VOP Key Words and Terms

16S rRNA	internal promoters	rRNA
18S rRNA	introns	rRNA cleavage
23S rRNA	lariat	rRNA endonucleases
28SrRNA	mature RNA transcript	σ -factor
45S pre-rRNA	mRNA	SINEs
45S rRNA methylation	mRNA capping	snRNP
4S rRNA	mRNA polyadenylation	spacer RNA
5'-methyl guanosine capping	mRNA splicing	splice sites
5S rRNA	operons	spliceosome
8S rRNA	poly (A) polymerase	Svedborg unit
adenine	poly(A) tail	TATA binding protein
Alu	polycistronic RNA	TBP
branch sites	Pribnow box	termination
crossing over	promoter	TFIIB, TFGIIE, TFIIF, TFIIH
cytosine	recombination	transcription
DNA binding proteins	regulatory DNA sequence	transcription start site
<i>E. coli</i> RNA polymerase	regulatory factor	transcription unit
elongation	rho termination factor	translation
eukaryotic RNA polymerases	rho-independent termination	transposition
exon shuffling	ribonucleoproteins	transposons

exons	RNA polymerase I	tRNA
guanine	RNA polymerase II	tRNA processing
helitrons	RNA polymerase III	upstream v. downstream
helix-turn-helix motif	RNA processing	uracil
initiation	RNA secondary structure	

Chapter 11: The Genetic Code and Translation

The Genetic Code, tRNA (Adapter) Molecules, Translation (Protein Synthesis),



<http://4.bp.blogspot.com/->

[owjlfkht5QI/T340bDX71TI/AAAAAAAAAyg/TEalSV1taXk/s1600/decoder+ring+census.jpg](http://4.bp.blogspot.com/-owjlfkht5QI/T340bDX71TI/AAAAAAAAAyg/TEalSV1taXk/s1600/decoder+ring+census.jpg)

I. Introduction

We begin this chapter with a look at how the *genetic code* was broken (deciphered). The very terms *genetic code*, *broken* and *deciphered* came from what was at the time, the recent history of the World War II, the winning of which relied so heavily on breaking enemy codes (recall the *Enigma* machine) and hiding battle information from the enemy (recall the Navajo *code talkers*). We'll look at the elegant experiments that first deciphered the amino acid meaning of a few 3-base *codons*, and then all 64 codons. Of these, 61 encode amino acids and three are *stop* codons. The same kinds of experiments that broke the genetic code also led to our understanding of the mechanism of protein synthesis. Early assumptions were that genes and proteins were *colinear*, i.e., that the length of a gene was directly proportional to the polypeptide it encoded. It followed then that the length of mRNAs to be translated would also be collinear with their translation products. *Colinearity* suggested the obvious hypotheses that translation proceeded in 3 steps, just like transcription itself. We now know that *initiation* involves the assembly of a translation machine near the 5' end of the mRNA.

This machine consists of ribosomes, mRNA, several initiation factors and a source of chemical energy. mRNAs are actually longer than needed to specify a polypeptide (even after splicing!). One function of *initiation factors* is to position the ribosome and associated proteins near the *start codon* (for the first amino acid in the new protein). Once an *initiation complex* forms, *elongation* begins. Cycles of condensation reactions on the ribosome connect amino acids by peptide linkages, growing the chain from its amino- to its carboxyl end. Translation ends when the ribosome moving along the mRNA encounters a stop codon. We'll look in some detail at these steps of translation here, and at how new polypeptides are processed in later chapters.

Voice-Over PowerPoint Presentations

[RNA Translation: The Genetic Code](#)

[Translation: Initiation](#)

[Translation: Elongation](#)

[Translation: Termination](#)

Learning Objectives

When you have mastered the information in this chapter and the associated VOPs, you should be able to:

1. compare and contrast the *mechanisms* and *energetics* of initiation, elongation and termination of translation and transcription
2. speculate on why *the genetic code is universal* (or nearly so)
3. justify early thinking about a *4-base genetic code*
4. justify early thinking about an *overlapping genetic code* (for example, one in which the last base of a codon could be the first base of the next codon in an mRNA)
5. explain why all *tRNA structures* share some, but not other features
6. compare and contrast the roles of the ribosomal *A, E and P sites* in translation
7. trace the formation of an *aminoacyl-tRNA* and the *Initiation Complex*
8. describe the steps of translation that require chemical energy from NTPs
9. formulate an hypothesis to explain why stop codons all begin with U
10. create a set of rules for inferring an amino acid sequence from a stretch of DNA sequence
11. speculate about why the large human (in fact any eukaryotic) genome codes for so few proteins

II. The Genetic Code

A. Overview

The **genetic code** is the information for linking amino acids into polypeptides in an order based on the base sequence of 3-base code words (**codons**) an mRNA. With a few exceptions (some prokaryotes, mitochondria, chloroplasts), **the genetic code is**

universal – it's the same in all organisms from bacteria to humans. The **Standard Universal Genetic Code** is shown as a table of RNA codons below.

		non-polar polar basic acidic stop codon							
1st base	2nd base								3rd base
	U		C		A		G		
U	UUU	Phenylalanine (F)	UCU	Serine (S)	UAU	Tyrosine (Y)	UGU	Cysteine (C)	U
	UUC		UCC		UAC		UGC		C
	UUA	UCA	UAA		stop codon	UGA	stop codon	A	
	UUG	UCG	UAG			UGG		Tryptophan (W)	G
C	CUU	Leucine (L)	CCU	Proline (P)	CAU	Histidine (H)	CGU	Arginine (R)	U
	CUC		CCC		CAC		CGC		C
	CUA		CCA		CAA	Glutamine (Q)	CGA		A
	CUG		CCG		CAG		CGG		G
A	AUU	Isoleucine (I)	ACU	Threonine (T)	AAU	Asparagine (N)	AGU	Serine (S)	U
	AUC		ACC		AAC		AGC		C
	AUA	ACA	AAA		Lysine (K)	AGA	Arginine (R)	A	
	AUG	ACG	AAG			AGG		G	
G	GUU	Valine (V)	GCU	Alanine (A)	GAU	Aspartic Acid (D)	GGU	Glycine (G)	U
	GUC		GCC		GAC		GGC		C
	GUA		GCA		GAA	Glutamic Acid (E)	GGA		A
	GUG		GCG		GAG		GGG		G

From: www.manylabs.org

The translation machine is the **ribosome**, but the *decoding* device is tRNA. Each amino acid is attached to a tRNA whose short sequence contains a 3-base *anticodon* that is complementary to an mRNA codon. Enzymatic reactions catalyze the **dehydration synthesis (condensation)** reactions that link amino acids together by *peptide bonds*, in an order specified by the codons in the mRNA. In the universal genetic code, **stop codons** 'tell' ribosomes the location of the last amino acid to be added to a polypeptide.

There is only one codon for methionine (AUG), but cells have evolved to use AUG both as the **start codon** (so that all polypeptides begin life with an amino-terminal methionine) *and* for the placement of methionine within a polypeptide. Interestingly, there is also only one codon for tryptophan, but there are two or more codons for each of the 18 remaining amino acids. For the latter reason, we say that the genetic code is **degenerate**.

The near-universality of the genetic code from bacteria to humans implies that the code originated early in evolution. In fact it is probable that portions of the code were in place even before life began. Once in place, the genetic code was highly constrained against change during subsequent evolution. This feature of our genomes allows us to compare gene and other DNA sequences to establish and confirm important evolutionary relationships between organisms (species) and groups of organisms (genus, family, order, etc.).

Despite the universality of the genetic code and the availability of 61 codons that specify amino acids, some organisms show *codon bias*. Codon bias refers to a tendency to favor certain codons in genes so that in some organisms, some genes use codons with more adenines and thymines, while the genes of other organisms might favor codons richer in guanines and cytosines.

CHALLENGE: What (and where!?) might be an evolutionary advantage of codon bias?

Finally, we tend to think of genetic information as DNA that codes for proteins even though not all genetic information is stored in the genetic code. Much of the non-coding genome includes introns, regulatory DNA sequences, intergenic segments, DNA sequences supporting chromosome structural areas, and other DNA that can contribute greatly to phenotype, but that is not transcribed into mRNA. We will look at how genes are regulated and how patterns of regulation are inherited (the relatively new field of **epigenetics**) in the next chapter. For now, simply consider that in prokaryotes, much of the genome (i.e., the circular chromosomal DNA) is devoted to encoding proteins. Compare this to DNA in the chromosomes of eukaryotes where only a few percent of the DNA encodes polypeptides. Non-coding DNA can exceed 95% of the DNA in the cells of higher organisms!

B. How Was the Code Deciphered?

Serious efforts to understand how proteins are encoded began after Watson and Crick used the experimental evidence of Maurice Wilkins and Rosalind Franklin (among others) to determine the structure of DNA. Most hypotheses about the genetic code assumed that DNA (i.e., genes) and polypeptides were **colinear**. This certainly turned out to be the case in early gene mapping experiments on the bacterium *E. coli*.

The concept of colinearity is illustrated below.

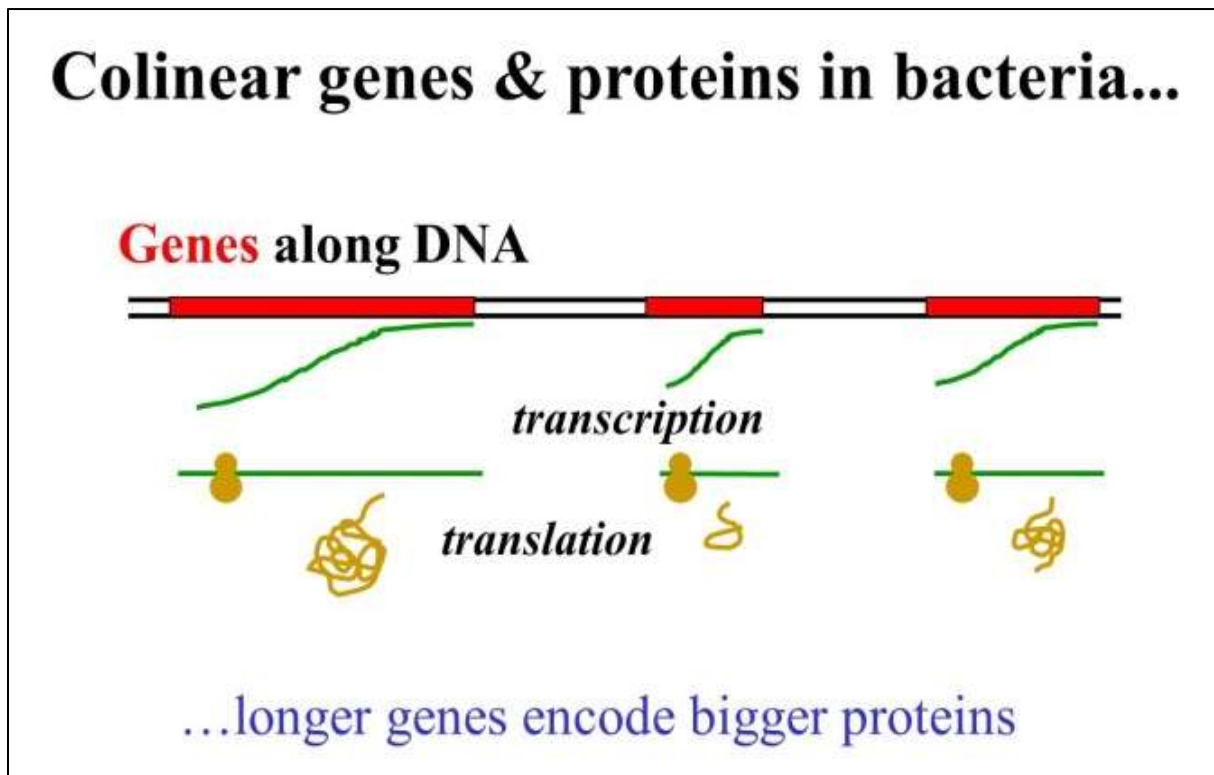

If the genetic code is collinear with the polypeptides it encodes, then a 1-base **codon** would not work because such a code would only account for 4 amino acids. A 2-base genetic code also won't work because it could only account for 16 (4^2) of the 20 amino acids found in proteins. A code of 3 nucleotides would code for a maximum of 4^3 or 64 amino acids, more than enough to encode the 20 amino acids, while a 4-base code also satisfies the expectation that genes and proteins are collinear (with the 'advantage' that there were 256 possible codons to choose from, i.e., 4^4 possibilities). However, the simplest hypothesis predicts the 3-base code, with **triplet codons**.

So, the next issue was how the triplet codons would be read by the cell's translation machine. One idea that would ensure that a maximum number of genes could be contained in a genome of fixed size was that the translation machine (the ribosome, with input from mRNA and tRNA) would be read in an overlapping manner. This would require that only 20 of the 64 possible triplet codons would actually correspond to the 20 amino acids.

George Gamow (a Russian Physicist who became interested in DNA while working at George Washington University), was the first to propose a three-letter code to encode the 20 amino acids. It seemed a simple way to account for a 3-base code and the colinearity of gene and protein..., and to ensure that there would be room in the cell's DNA to encode all possible genes.

Sidney Brenner, together with Frances Crick performed elegant bacterial genetic studies that proved that the genetic code was indeed made up of triplet codons and further, that the code was non-overlapping! These *gene mapping* experiments revealed that deleting a single base from the coding region of a gene caused the mutant bacterium to fail to make the expected protein. Likewise, deleting 2 bases from the gene led to failure to make the protein. But bacteria containing a mutant version of the gene in which 3 bases were deleted proceeded to make the protein, albeit a slightly less active version of the protein.

If only 20 of the 64 possible triplet codons actually encoded amino acids, how would the translational machinery recognize the correct 20 codons to translate, rather than the supposedly **meaningless** 3-base sequences that would overlap two "real", or **meaningful** codons? One speculation was that the code was *punctuated*. That is, perhaps there was the chemical equivalent of commas between the meaningful triplets. The commas of course were had to be nucleotides. This meant that there were 44 meaningless codons, and that any attempt to read the code beginning at the 2nd or 3rd base in a meaningful codon would read a meaningless, or nonsense triplet.

Then, Crick proposed the *Commaless Genetic Code*. He was cleverly able to divide the 64 triplets into 20 *meaningful* codons that encoded the amino acids and 44 *meaningless* ones that did not, such that when the 20 *meaningful* codons were placed in any order, any of the triplets read in overlap would be among the 44 *meaningless* codons. In fact, he could arrange several different sets of 20 and 44 triplets with this property! As we know, the genetic code is indeed commaless... but not in the sense that Crick had envisioned.

When the genetic code was actually broken, it was found that 61 of the codons specify amino acids and therefore, the code is *degenerate*. Breaking the code began when Marshall Nirenberg and Heinrich J. Matthaei decoded the first triplet. They fractionated *E. coli* and identified which fractions had to be added back together in order to get polypeptide synthesis in a test tube (*in vitro* translation). Check out the original work in the classic paper by Nirenberg MW and Matthaei JH [(1961) *The dependence of cell-free protein synthesis in E. coli upon naturally occurring or synthetic polyribo-nucleotides*. *Proc. Natl. Acad. Sci. USA* 47:1588-1602].

The cell fractionation is summarized below.

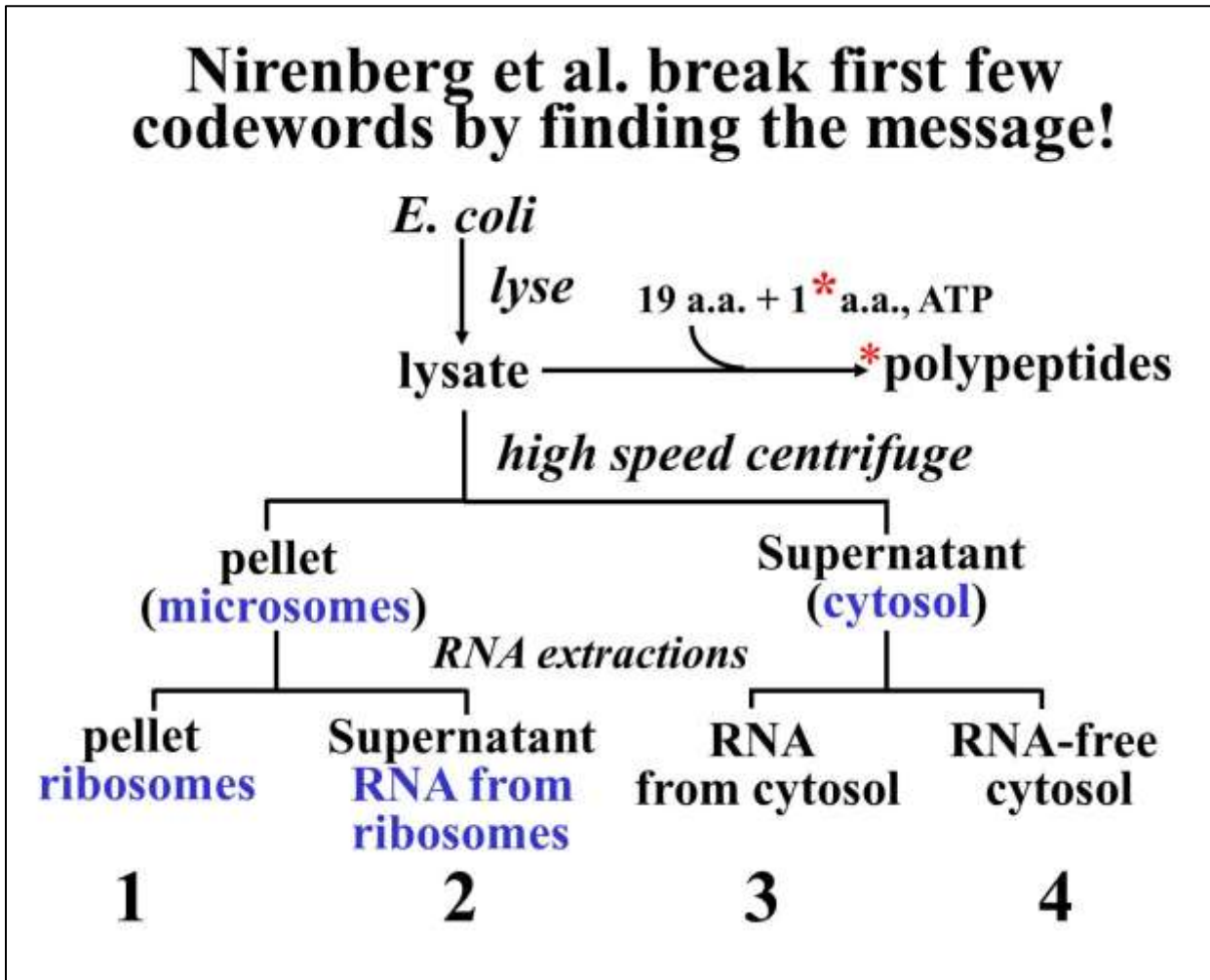

The various cell fractions isolated by this protocol were added back together along with amino acids (one of which was radioactive) and ATP as an energy source. After a short incubation, Nirenberg and his coworkers looked for the presence of high molecular weight radioactive proteins as evidence of cell-free protein synthesis. They found that all four final fractions had to be added together to make radioactive proteins in the test tube.

One of the essential cell fractions consisted of RNA that had been gently extracted from ribosome (fraction 2 in the illustration). Reasoning that this RNA might be mRNA, they substituted a synthetic poly(U) preparation for this fraction in their cell-free protein synthesizing mix, expecting that poly(U) would encode a simple repeating amino acid.

They set up 20 reaction tubes, with a different amino acid in each... and made poly(phe). The experiment is illustrated below.

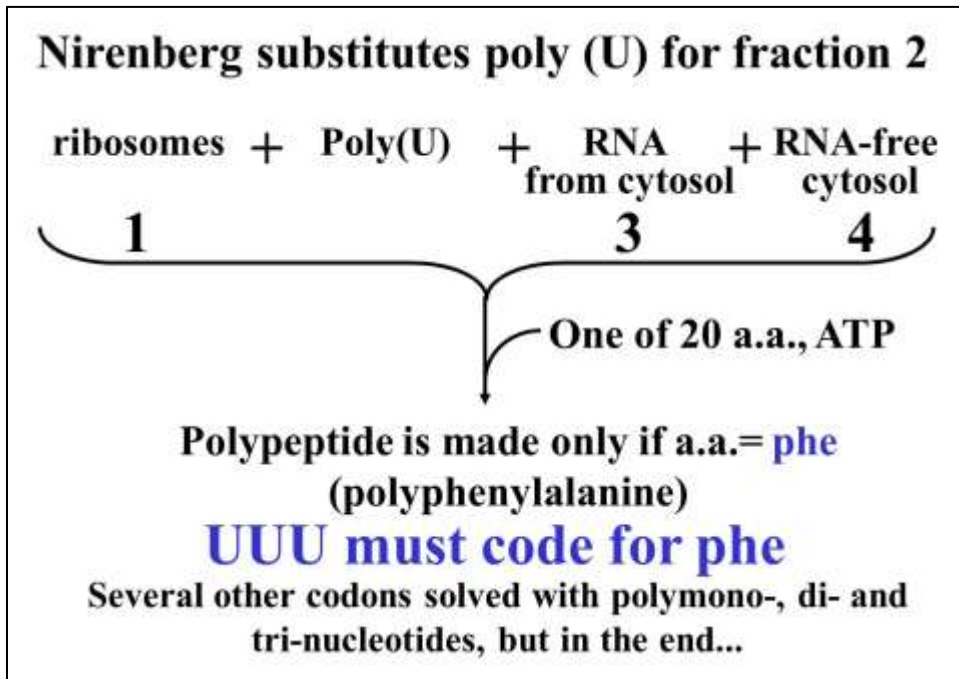

So, the triplet codon UUU means *phenylalanine*. Other polynucleotides were synthesized by G. Khorana, and in quick succession, poly(A) and poly(C) were shown to make poly lysine and poly proline in this experimental protocol. Thus AAA and CCC must encode *lysine* and *proline* respectively. With a bit more difficulty and ingenuity, poly di- and tri-nucleotides were also tested in the cell free system, deciphering additional codons. M. W. Nirenberg, H. G. Khorana and R. W. Holley shared the 1968 Nobel Prize in Physiology or Medicine for their contributions to our understanding of protein synthesis. But deciphering most of the genetic code was based on Crick's realization that chemically, amino acids have no attraction for either DNA or RNA (or triplets thereof). Instead he predicted the existence of an **adaptor molecule** that would contain nucleic acid and amino acid information on the same molecule.

Today we recognize this molecule as **tRNA**, the genetic *decoding device*. Nirenberg and Philip Leder designed the experiment that pretty much *broke* the rest of the genetic code. They deciphered the genetic code by adding individual amino acids to separate test tubes containing tRNAs, in effect causing the synthesis of specific aminoacyl-tRNAs. They then mixed their amino acid-bound tRNAs with isolated ribosomes and synthetic triplets.

Since they already knew that 3-nucleotide fragments would bind to ribosomes, the hypothesized that triplet-bound ribosomes would bind appropriate amino acid-bound tRNAs. The experiment is illustrated below.

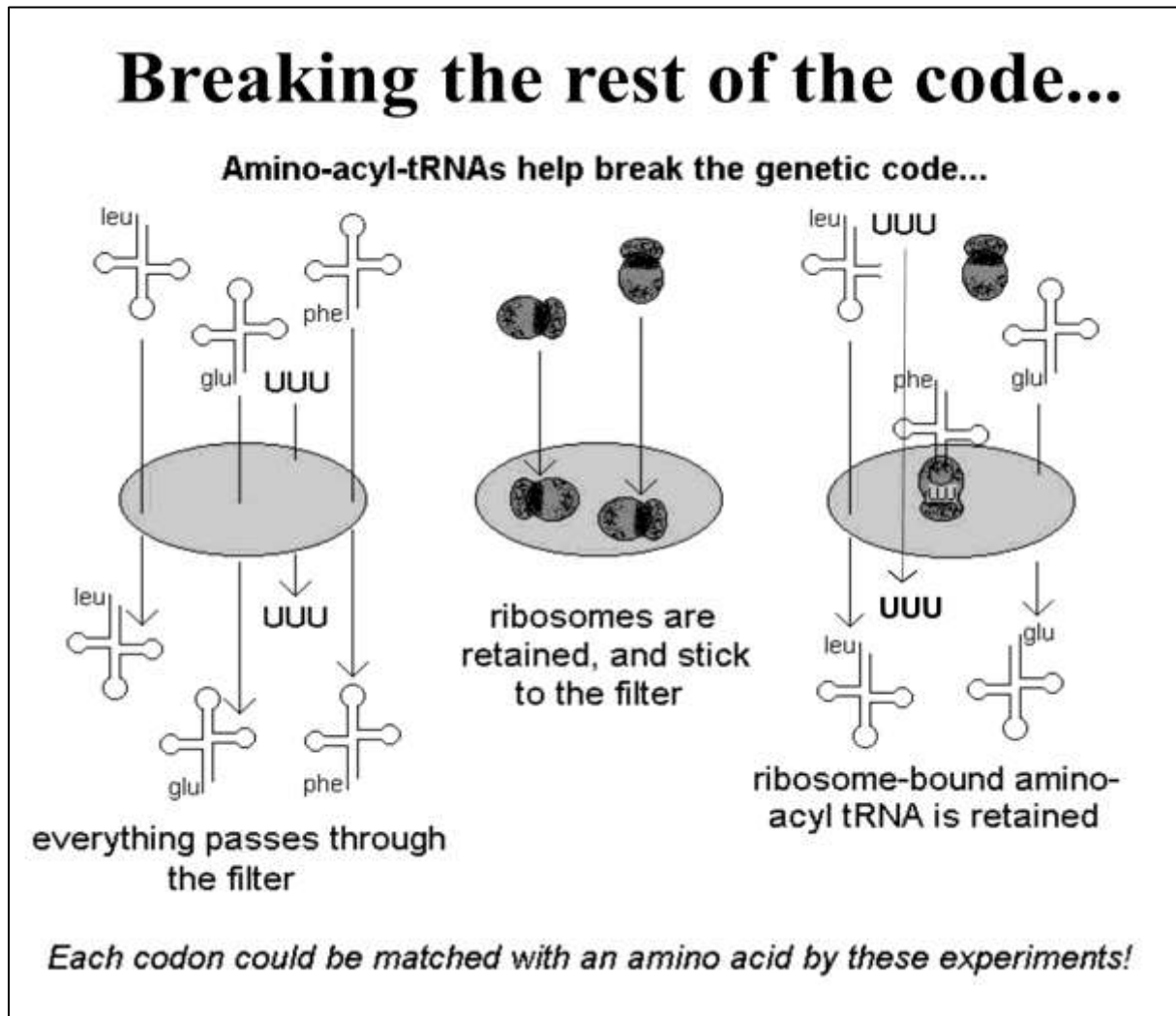

Various combinations of tRNA, ribosomes and aminoacyl-tRNAs were placed over a filter. Nirenberg and Leder knew that aminoacyl-tRNAs alone passed through the filter and that ribosomes did not. They predicted then, that triplets would associate with the ribosomes, and further, that this complex would bind the tRNA with the amino acid encoded by the bound triplet. This 3-part complex would also be retained by the filter, allowing the identification of the amino acid retained on the filter, and therefore the triplet code-word that had enabled binding the amino acid to the ribosome.

After the code was largely deciphered, Robert Holley actually sequenced and predicted the folded structure of a yeast tRNA. At one end of the tRNA he found the amino acid alanine. Roughly in the middle of the short tRNA sequence, he found one of the anticodons for an alanine codon. The illustration below shows the “stem-&-loop structure predicted by Holley (at left). A later computer-generated structure revealed a now familiar “L”-shaped molecule with an *amino acid attachment site* at the 3'-end of the molecule, and an *anticodon loop* at the other 'end'.

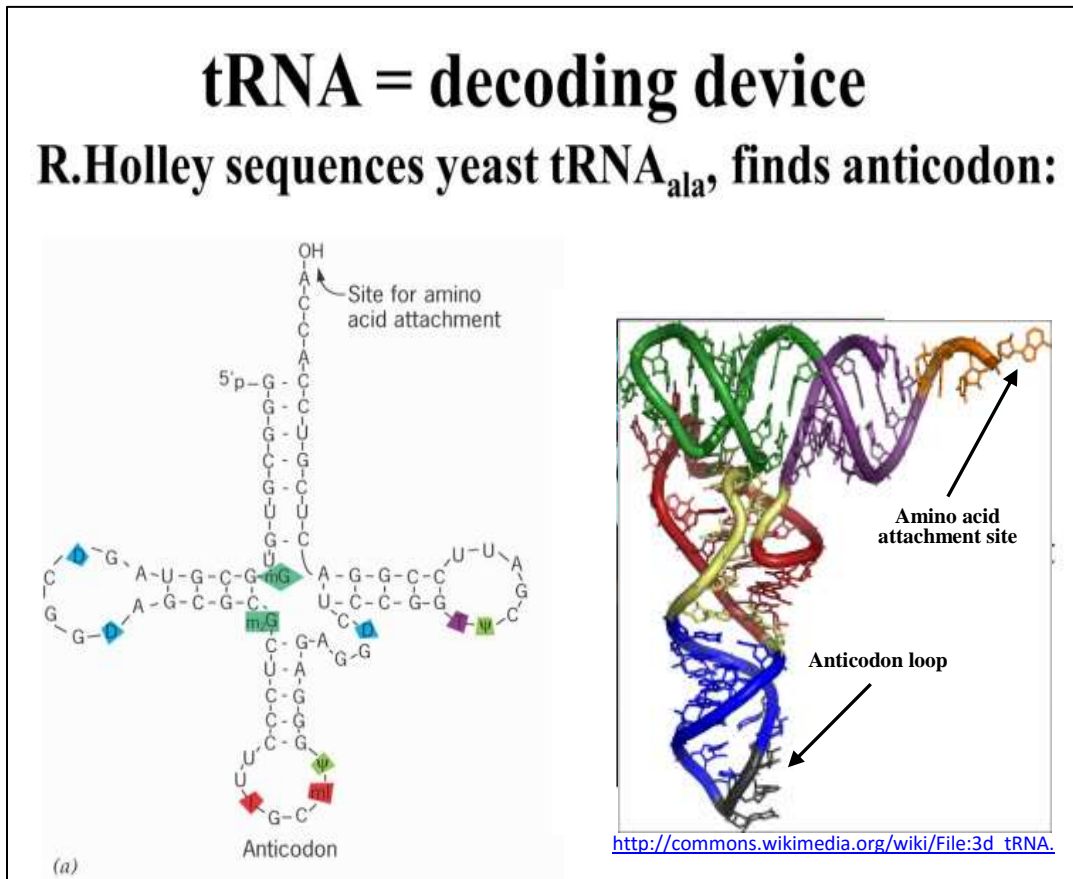

III. Translation

I. Overview of Translation (Synthesizing Proteins)

Like any polymerization in a cell, translation occurs in three steps: **initiation** brings a ribosome, mRNA and a *starter* tRNA together to form an initiation complex.

Elongation is the successive addition of amino acids to a growing polypeptide.

Termination is signaled by sequences (one of the stop codons) in the mRNA and protein **termination factors** that interrupt elongation and release a finished polypeptide.

The events of translation occur at specific **A**, **P** and **E** sites on the ribosome (see drawing below).

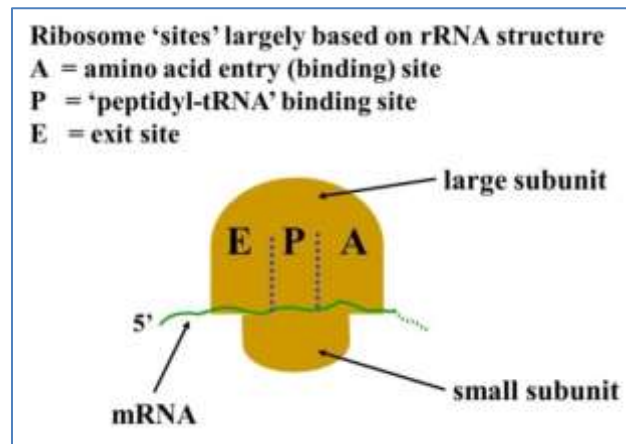

II. Translation – First Steps

1. Making Aminoacyl-tRNAs

Even before translation can start, the amino acids must be attached to their tRNAs. This is what was happening in Nirenberg and Leder’s experiments that broke most of the genetic code. The basic reaction is the same for all amino acids and is catalyzed by an **aminoacyl synthase** specific for **charging** each tRNA with an appropriate amino acid. Charging tRNAs (also called **amino acid activation**) requires energy and proceeds in 3 steps (shown below).

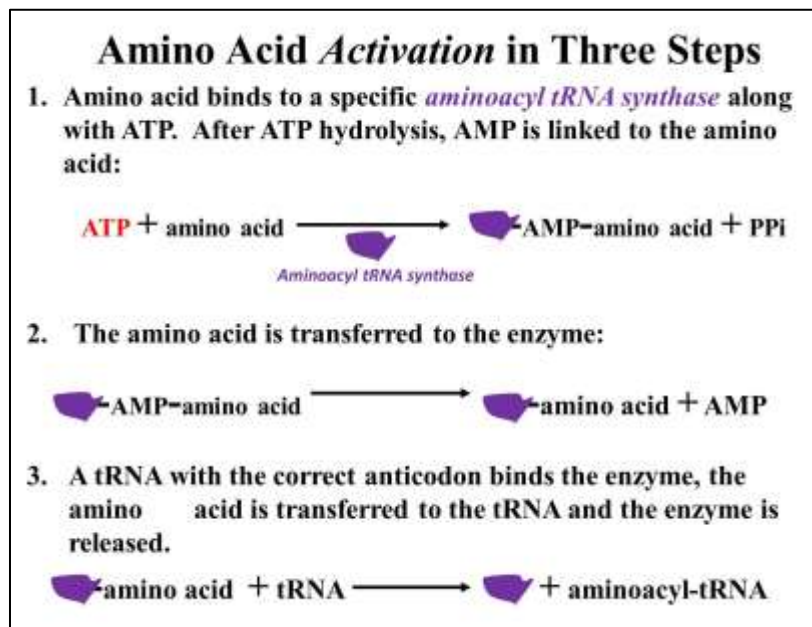

In the first step, ATP and an appropriate amino acid bind to the aminoacyl-tRNA synthase. ATP is hydrolyzed releasing a pyrophosphate (PPi), leaving an enzyme-AMP-amino acid complex. Next, the amino acid is transferred to the enzyme, releasing the AMP. Finally, the tRNA binds to the enzyme, the amino acid is transferred to the tRNA and the intact enzyme is regenerated and released. The charged tRNA is ready to use in translation.

Earlier studies had established that polypeptides are synthesized from their amino (N-) terminal end to their carboxyl (C-) terminal end. When it became possible to determine the amino acid sequences of polypeptides, it turned out that around 40% of *E. coli* proteins had an N-terminal methionine, suggesting that all proteins began with a methionine. It also turned out that, even though there is only one codon for methionine, two different tRNAs for methionine could be isolated.

One of these tRNAs was bound to a methionine modified by *formylation*, called **formylmethionine-tRNA_{fmet}**. The other was **methionine-tRNA_{met}**, charged with an unmodified methionine:

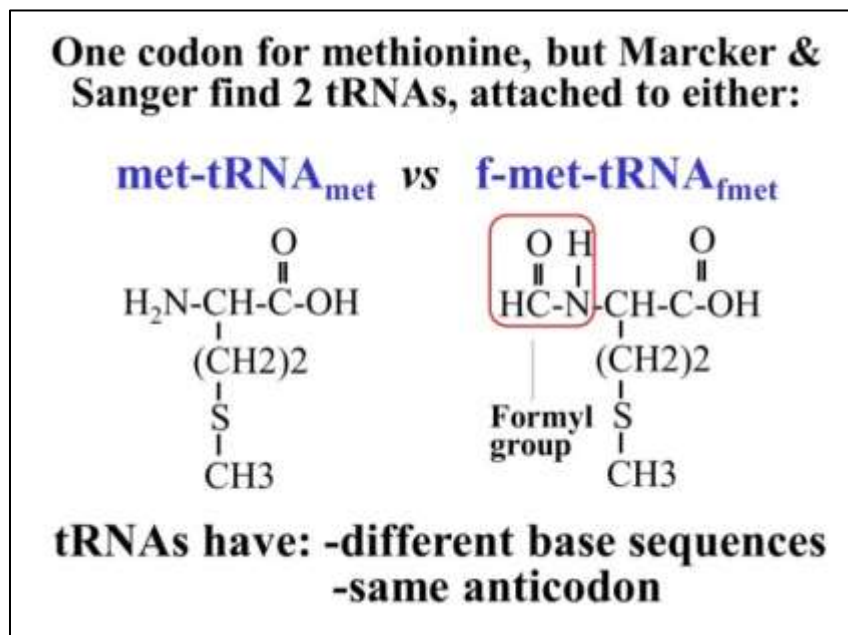

tRNA_{met} is used to insert methionine in the middle of a polypeptide, while the other is the *initiator* methionine tRNA (**tRNA_{fmet}**), used only to start new polypeptides with formylmethionine. In prokaryotes the *initiator* methionine is attached to an initiator tRNA with an anticodon to the AUG codon, and then *formylated* at its amino group to make the formylmethionine-tRNA_{fmet}.

Presumably, the evolutionary value of *formylation* of the amino group is that it prevents addition of amino acids to the N-terminal side of the methionine, keeping elongation going only towards the C-terminal end. For all proteins, the formyl group is removed post-translationally. For about 60% of *E. coli* (and for virtually all eukaryotic polypeptides), the methionine itself (and sometimes more N-terminal amino acids) are also removed.

Now that we have charged the tRNAs, we can look more closely at the three steps of translation in more detail.

2. *Initiation*

The following details were worked out by studying cell-free (*in vitro*) protein synthesis in *E. coli*, but are similar in eukaryotic cells. Cell fractionation, protein purifications and reconstitution experiments eventually revealed the order of events described here. Initiation starts with when the **Shine-Delgarno** sequence, a short nucleotide sequence near the 5' end of an mRNA, forms H-bonds with a complementary sequence in the **16S rRNA** bound to 30S ribosomal subunit. This requires the participation of initiation factors **IF1** and **IF3**. In this event, IF1 and IF3 as well as the mRNA are bound to the 30S ribosomal subunit (below).

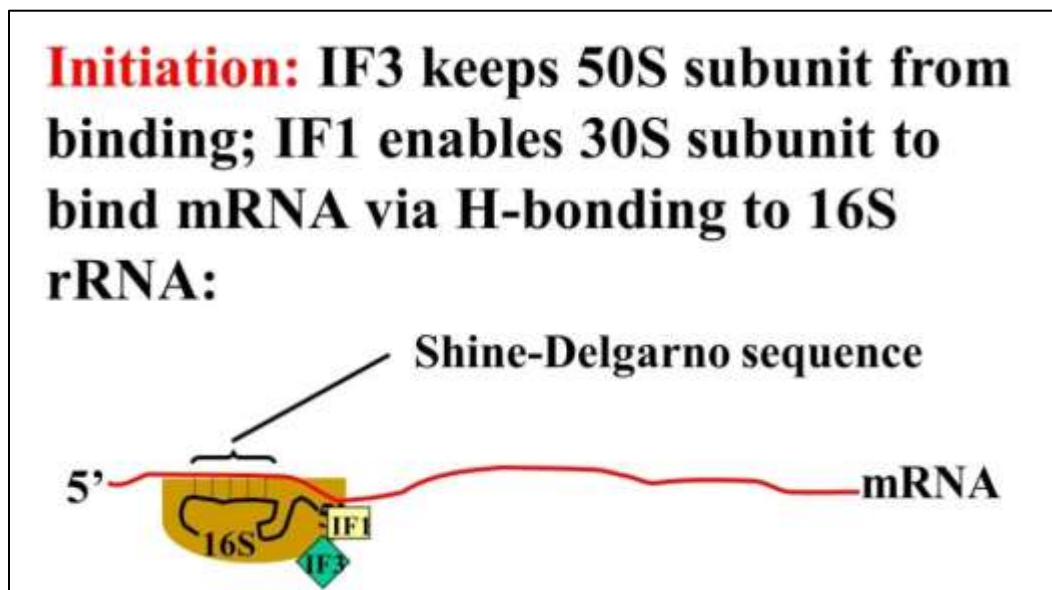

The Shine-Delgarno sequence is part of the region of an mRNA called the **5' untranslated region (5'-UTR)** of the messenger RNA. Next, with the help of GTP and initiation factor 2 (**IF2**), the initiator formyl methionine-bound tRNA ($\text{fmet-tRNA}_{\text{fmet}}$) recognizes and binds to the initiator AUG codon found in all mRNAs. Some call the resulting structure (shown below) the **Initiation Complex**.

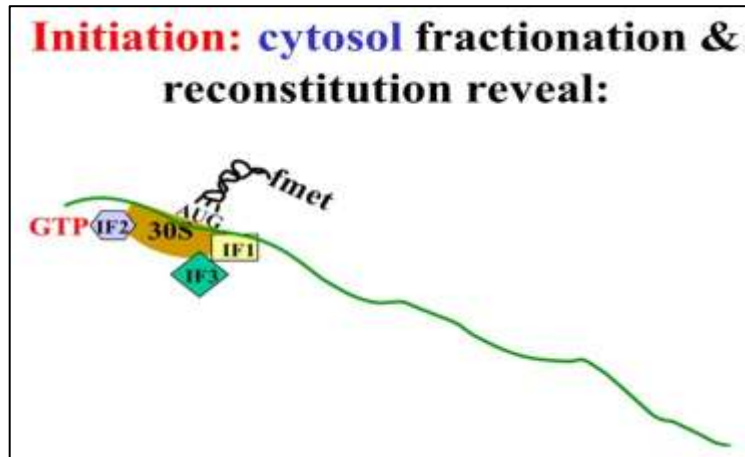

In the last step of initiation, the large ribosomal subunit binds to this complex, with the concurrent disassociation of the initiation factors. The initiator $\text{fmet-tRNA}_{\text{fmet}}$ ends up in the P site of the ribosome. Some prefer to call the structure formed at this point the **Initiation Complex** (below).

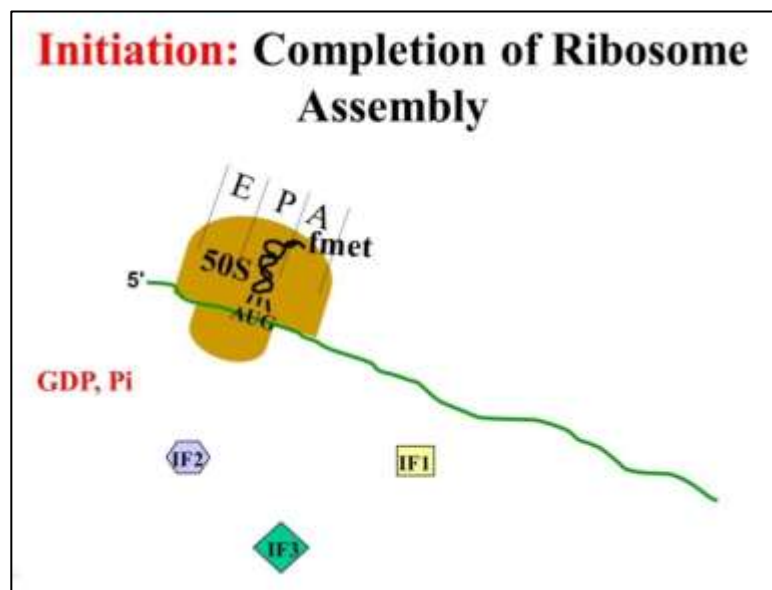

The sequence of steps in *Initiation* is animated at the following links:

- Small subunit binds mRNA: <http://youtu.be/0m-PXfWWxNA>
- Formation of an initiation complex: <http://youtu.be/KoU9y3W3wsk>

In the next steps, look for the entry of a second aa-tRNA_{aa} into an amino acid entry site on the ribosome. These events will start the polypeptide elongation process.

3. Elongation

Elongation is a sequence of protein factor-mediated condensation reactions and ribosome movements along an mRNA. The key steps are illustrated below.

a) *Elongation-1:*

Facilitated by an *elongation factor* and energy from GTP hydrolysis, an aminoacyl-tRNA (here, the second one) carries its amino acid to the A site of the ribosome based on mRNA codon-tRNA anticodon interaction. A second *elongation factor* re-phosphorylates the GDP (summarized below).

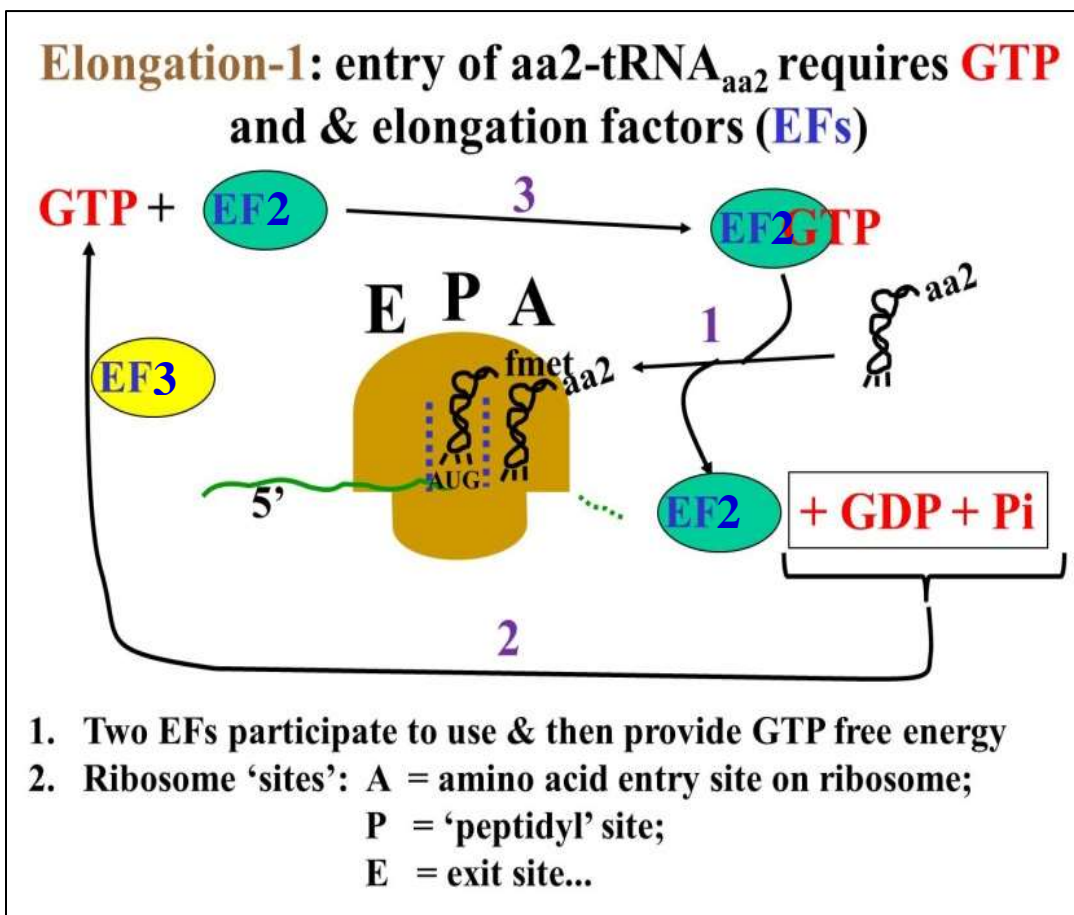

b) Elongation-2:

The incoming amino acid is linked to a growing chain in a condensation reaction, a reaction catalyzed by **peptidyl transferase**, a **ribozyme** component of the ribosome itself.

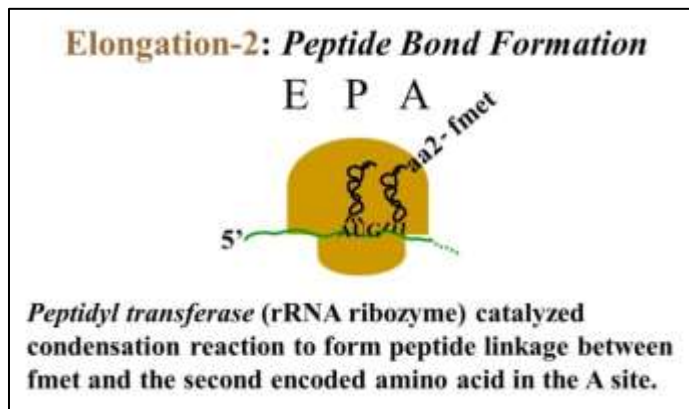

c) Elongation 3:

Translocase catalyzes GTP hydrolysis as the ribosome is moved (translocated) along the mRNA. After translocation, the next mRNA codon shows up in the A site of the ribosome.

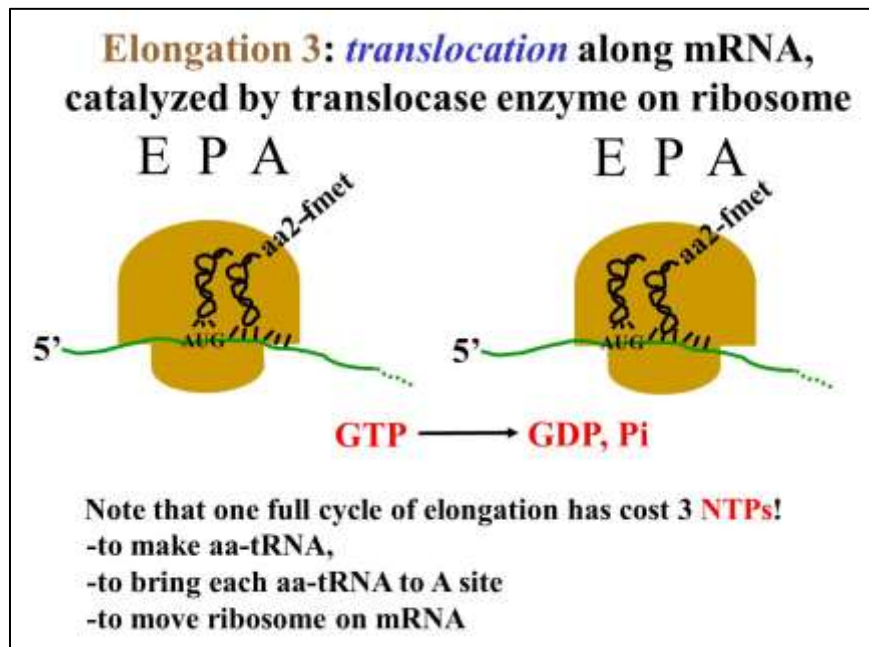

The prior tRNA, no longer attached to an amino acid, will exit the E site as the next (3rd) aa-tRNA enters the A site (again, based on a specific codon-anticodon interaction) to begin another cycle of elongation.

Note that for each cycle of elongation, 3 NTPs (an ATP and two GTPs) have been hydrolyzed, making protein synthesis the most expensive polymer synthesis reaction in cells! The sequence of steps in *Elongation* is animated at this link:

http://youtu.be/swy_qV6_Fb8

4. Termination

Translation of an mRNA by a ribosome ends when translocation exposes one of the 3 stop codons near the 3'-end of on the mRNA in the A site of the ribosome. Since there is no aminoacyl-tRNA with an anticodon to the stop codons (UAA, UAG or UGA), the ribosome actually stalls at this point. The translation slow-down is just long enough for a protein **termination factor** to enter the A site.

This interaction causes release of the new polypeptide and disassembly of the ribosome. The process, summarized below, requires energy from yet another GTP hydrolysis. After dissociation, ribosomal subunits can be reassembled with an mRNA for another round of protein synthesis.

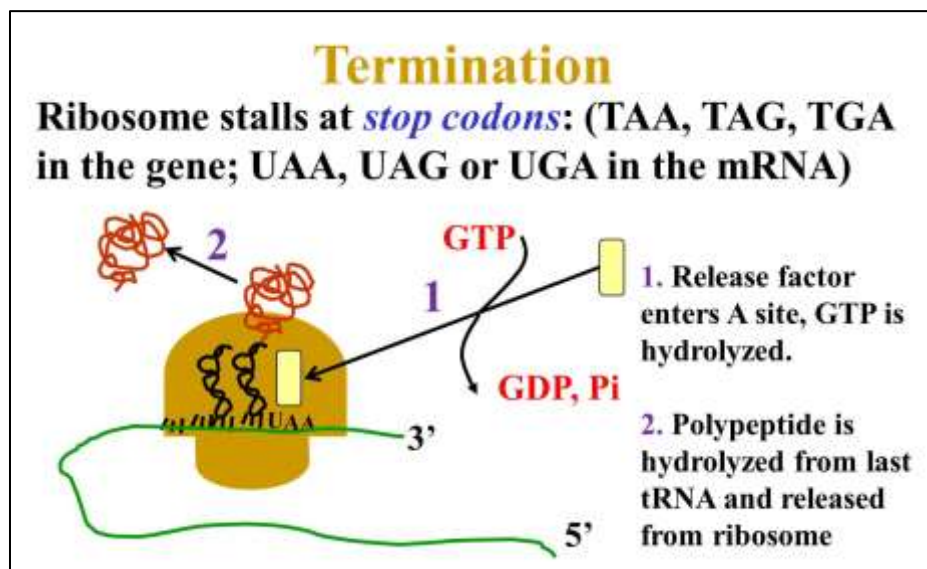

Termination is animated at <https://www.youtube.com/watch?v=pS2zzenWOHE>

The region of the mRNA from the stop codon to the 3' end of the messenger RNA is called the **3' untranslated region** of the messenger RNA (**3'UTR**).

Apparently, that's not the end of the story...! Fascinating results of recent studies reveal that translation is sometimes **re-initiated** in the 3' UTR of mRNAs, resulting in the translation of short, apparently functional peptides after all! Click here to read more: [Peptides from translation of mRNA 3'UTR](#).

Two final notes about translation:

1. Multiple ribosomes can translate an mRNA at the same time, forming a polyribosome, or polysome for short (see Ch. 1).
2. We have seen some examples of post-translational processing. Most proteins, especially in eukaryotes, undergo one or more additional steps of post-translational processing before becoming biologically active. We'll see examples in upcoming chapters.

Some iText & VOP Key Words and Terms

64 codons	genetic code	ribonucleoprotein
adapter molecules	initiation	ribosome
amino terminus	initiation complex	small ribosomal subunit
aminoacyl tRNA	initiation factors	start codon
aminoacyl tRNA synthase	initiator tRNA	stop codons
amino acid attachment site	large ribosomal subunit	termination
anticodon	meaningful codons	termination factor
AUG	mRNA, tRNA	translocation
bacterial bound ribosomes	nascent chains	triplets
Carboxyl-terminus	ochre, amber, opal	tRNA v. tRNA ^{Aaa}
colinearity	peptide linkage	UAG, UUA, UGA
comma-less genetic code	peptidyl transferase	universal genetic code
degenerate genetic code	polypeptide	UUU
elongation	polysome	Wobble Hypothesis
free v. bound ribosomes	reading phase	

CHALLENGE (Try your hand at this!): What was Crick trying to explain with his *Wobble Hypothesis*?

Chapter 12: Gene Regulation and Epigenetic Inheritance

Gene repression and induction (prokaryotes); Multiple transcription factors (eukaryotes); Regulatory elements in DNA; Post-transcriptional control of gene expression; Memories of gene regulation (epigenetics)



I. Introduction

This chapter is most broadly about metabolic regulation, the control of how much of a given structural protein or enzyme a cell has at any given moment. It is the steady-state level (concentration of the proteins) in a cell that determines its metabolic state or potential. The metabolic potential of cells is flexible, responding to external chemical signals or to developmental prompts that lead to changes in the amount or activity of proteins. Prokaryotic cells regulate gene expression in response to external *environmental signals*. Eukaryotes also control gene expression in response to external environmental signals, as well as to chemical signals in their extracellular environment. In eukaryotes these activities are superimposed on a *developmental program* of gene expression stimulated by the release of *molecular signals* (e.g., hormones). Responses to chemical signals ultimately lead to changes in transcription or translation rates and/or to changes in macromolecular *turnover rates* (i.e., the half-life of specific RNAs and proteins in cells). These mechanisms of up- and down-regulation of gene expression ultimately result in changes in protein levels and therefore cellular metabolism, growth and development. Transcription regulation is mediated by *transcription factors* that bind to specific DNA sequences *proximal* to gene promoters (both prokaryotes and eukaryotes), and/or *distal* to (far from) a gene (eukaryotes). Transcription factors are more numerous and varied in eukaryotes than prokaryotes, and must “see” DNA through chromatin. All cells of a species contain the same genes. This is more readily apparent in bacteria (and single-celled organisms in general), since parents and progeny are essentially identical. We’ll first consider prokaryotic gene regulation and then

look at different mechanisms of control of eukaryotic gene expression. We examine interactions between chromatin and gene regulatory factors in eukaryotes. We'll also look at the relatively new field of *Epigenetics*, how chromatin keeps memories of how genes are controlled for future generations of cells and even whole organisms. Next we consider *post-transcriptional regulation* including controls on rates of protein and mRNA turnover. We'll see how cells use specific proteins and some newly discovered *long* and *short* RNAs to recognize and target unwanted proteins and RNAs for degradation.

Voice-Over PowerPoint Presentations

[Gene Regulation in Prokaryotes](#)

[Gene Regulation in Eukaryotes](#)

[Gene Activity & Chromatin](#)

[Gene Activity: Epigenetic Inheritance](#)

[Gene Activity: Post-Transcriptional Regulation](#)

Learning Objectives

When you have mastered the information in this chapter and the associated VOPs, you should be able to:

1. compare and contrast *transcription factors* and so-called *cis-acting elements*
2. articulate the role of *DNA bending* in the regulation of gene expression
3. explain the benefits of bacterial *operon regulation*
4. explain why all bacterial genes are not organized into *operons*
5. compare and contrast regulation of the *lac* and *trp* operons in *E. coli*
6. compare and contrast *regulatory genes* and *structural genes* in *E. coli*
7. discuss why a 4th gene was suspected in *lac operon* regulation
8. distinguish between *repression* and *de-repression* and between *positive* and *negative* regulation, using examples. For example, explain how it is possible to have repression by positive regulation
9. draw and label prokaryotic and eukaryotic genes for a protein, with all functional regions
10. compare and contrast several different mechanisms of gene regulation in eukaryotic cells
11. describe the *transcription initiation complex* of a regulated gene in eukaryotes
12. As you would define them, articulate any differences between *gene expression* and *transcription regulation*
13. define a gene
14. distinguish between the roles of enhancers and other cis-acting elements in transcription regulation
15. compare and contrast the *genome* and the *epigenome*
16. compare and contrast the origins and functions of *miRNA* and *siRNA*
17. describe the main mechanisms for degrading unwanted proteins in eukaryotic cells and speculate on how bacteria might accomplish the same task

II. Gene Regulation in Prokaryotes

Many prokaryotic genes are organized as operons, linked genes that are transcribed into a single mRNA encoding 2 or more proteins. Operons usually encode proteins with related functions. By regulating the activity of an operon, amounts of their encoded proteins can be coordinately controlled. Genes for enzymes or other proteins whose expression must be controlled are called *structural genes* while those that encode proteins that bind DNA to control gene expression are called *regulatory genes*. The lac operon of *E. coli* is an example. The *polycistronic* mRNA transcript is simultaneously translated into each of the proteins encoded in the operon, as shown below (and described at <http://youtu.be/YN3qUL5svnQ>).

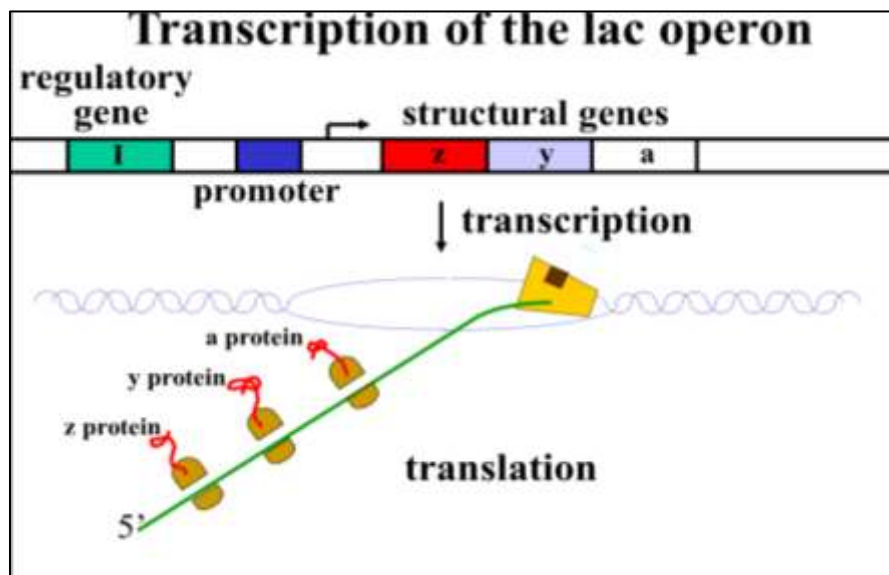

Regulation of an operon (or of an individual gene for that matter) can be by **repression** or by **induction**. If an operon is active unless inhibited by a repressor it is a repressible operon. If the operon is inactive but can be induced by a small molecule, it is called an *inducible operon*. Induction or repression can occur when such a molecule binds to an inducer protein that then binds to DNA near the gene causing it to be transcribed, causing it to be transcribed. The kicker is that the molecule might instead induce transcription by *de-repression*. Here a small molecule binds repressor protein, causing it to come off the DNA near the gene. In both cases, the small molecules are intracellular metabolites that reflect the metabolic status of the cell and thus the gene(s) that needs to be activated or silenced.

The *lac* and *trp* operons are good examples of bacterial gene regulation. The *lac operon* is regulated by induction by de-repression as well as by a positive inducer. The operon is also controlled by a process called *inducer exclusion* (see below). The *trp operon* is regulated by repression by a repressor protein. We'll look at the regulation of both operons in detail below.

A. Mechanisms of Control of the lac Operon

In the animal digestive tract (including ours), genes of the *E. coli* **lac operon** regulate the use of *lactose* as an alternative nutrient to glucose. Think of eating cheese instead of chocolate. The operon consists of three **structural genes**, *lacZ*, *lacY*, and *lacA*. Structural genes in bacteria are to be distinguished from **regulatory genes**. While both kinds of genes encode proteins, the regulatory genes encode proteins whose function is to bind to DNA and regulate the structural genes! The operon is transcribed into a multigene transcript (illustrated below). The basics of *lac* operon transcription are (silently!) animated at <http://youtu.be/RKf66-VzYI0>.

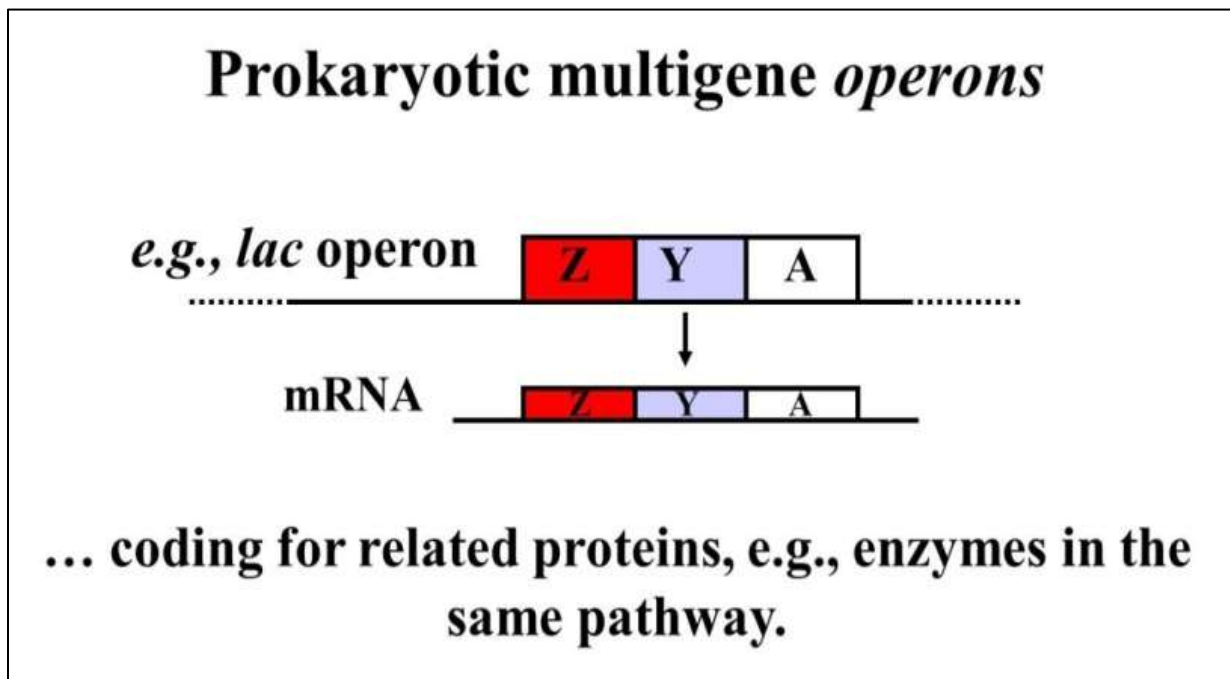

Since the preferred nutrient for *E. coli* is glucose, the cells will only use lactose as an alternative energy and carbon source if glucose levels in the environment are limiting. When glucose levels are low *and* lactose is available, the operon is transcribed and the 3 enzyme products are translated. The *lacZ* gene encodes ***β-galactosidase***, the enzyme that breaks lactose (a disaccharide) into *galactose* and glucose. The *lacY* gene encodes lactose ***permease***, a membrane protein that facilitates lactose entry into the cells. The role of the *lacA* gene (a ***transacetylase***) in lactose energy metabolism is not well understood. The *lac* operon is regulated by *derepression* as well as direct *induction*, leading to transcription of the *lac* genes only when necessary (i.e., in the presence of lactose and absence of glucose).

Repression of the lac operon when there is plenty of glucose around is by a *repressor protein* encoded by the *lacI* gene that lies just or to the left of, or by convention *upstream* of the operon (below).

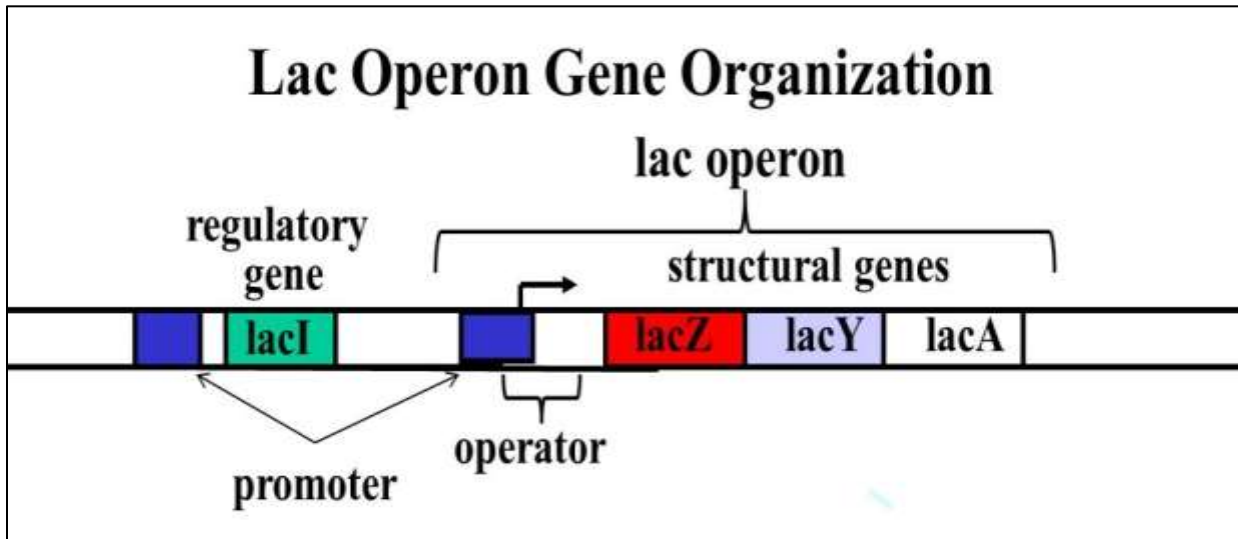

In the late 1950s and early 1960s, Francois Jacob and Jacques Monod were studying the use of different sugars as carbon sources by *E. coli*. They knew that when grown on glucose, *wild type E. coli* would **not** make the β -galactosidase, β -galactoside permease or β -galactoside transacetylase proteins. They then isolated different *E. coli* mutants that could not grow on lactose, even when there was no glucose in the growth medium. One mutant failed to make an active β -galactosidase enzyme but could make the permease enzyme. Another different mutant failed to make an active permease but made normal amounts of β -galactosidase. Mutants that could not make the transacetylase enzyme seemed able to metabolize lactose, hence the uncertainty of this enzyme's role in lactose metabolism. But even more curious, one mutant strain failed to make the galactosidase, permease and transacetylase, and of course, could not metabolize lactose. Since double mutants are very rare and triple mutants even rarer, Jacob and Monod inferred that the activation of all three genes in the presence of lactose was coordinated in some way. In fact this discovery defined the operon as a set of genes transcribed as a single mRNA, whose transcription could be easily coordinated. They later characterized a repressor protein produced by the *lacI* gene adjacent to the lac operon. Jacob, Monod and Andre Lwoff shared the Nobel Prize in Medicine in 1965 for their work on bacterial gene regulation. Negative and positive regulation of the lac operon (described below) depend on two regulatory proteins that together control the rate of lactose metabolism.

1. Negative Regulation of the *lac* Operon – Repression and De-repression

Refer to the illustration below to identify the players in *lac* operon induction.

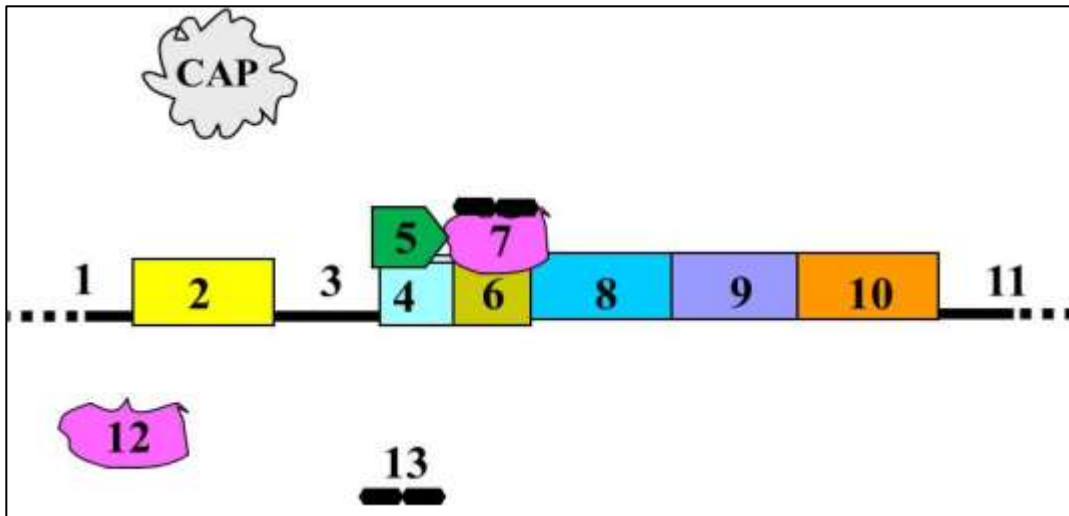

The first control mechanism involves a regulatory repressor protein called the ***lactose repressor*** (#12, #7). The ***lacI*** gene (#2) coding for the repressor protein lies upstream of the *lac* operon and is always expressed (such unregulated genes are called ***constitutive***). In the absence of lactose in the growth medium, the repressor protein binds very tightly to a short DNA sequence called the ***lac operator*** (#6) just downstream of the ***promoter*** (#4) the near the start of the ***lacZ*** gene. This binding interferes with binding of ***RNA polymerase*** (#5) to the promoter and its forward movement. Under these conditions, transcription of the ***lacZ***, ***lacY*** and ***lacA*** genes (#s 8, 9 & 10) occurs at very low levels. But when cells are grown in the presence of lactose, a lactose metabolite called ***allolactose*** (#13) is formed in the cell. Allolactose binds to the repressor sitting on the operator DNA (a 2-part complex shown as #7), causing a change in its shape. Thus altered, the repressor dissociates from the operator and the RNA polymerase is able to transcribe the *lac* operon genes, thereby leading to higher levels of the encoded proteins.

Activation of the *lac* operon by allolactose-mediated derepression is shown in the animation at the following link: <http://youtu.be/MNQ8CzhDfCg>

2. Induction of the *lac* Operon

The second control mechanism regulating *lac* operon expression is mediated by the ***cAMP***-bound ***catabolite activator*** protein, also called the cAMP receptor protein, or CAP. When glucose is available, cellular levels of cAMP are low in the cells and CAP

is in an inactive conformation. But if glucose is absent or its levels are low, cAMP levels rise and cAMP binds to the CAP. In its active conformation, CAP binds to the operon where it actually causes DNA to bend (below).

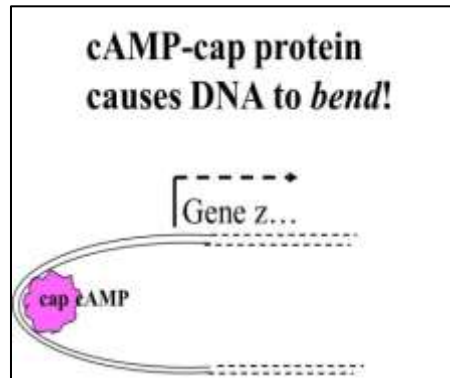

Bending the double helix loosens H-bonds, thus facilitating RNA polymerase binding and transcription initiation. If lactose is available, transcription of the lac genes is maximally induced by negative control (de-repression by allolactose) and positive control (by cAMP-bound CAP).

In recent years, additional layers of lac operon have been uncovered. In one case, the ability of lac permease in the cell membrane to transport lactose is regulated. In another case, additional operator sequences have been discovered that play a role in operon regulation.

3. Regulation of Lactose use by Inducer Exclusion

When glucose levels are high (even in the presence of lactose) phosphate is consumed to phosphorylate glycolytic intermediates, keeping cytoplasmic phosphate levels low. Under these conditions, unphosphorylated EIIA^{Glc} binds to the *lactose permease* enzyme in the cell membrane, preventing it from bringing lactose into the cell. On the other hand, if glucose levels are low in the growth medium, phosphate concentrations in the cells rise sufficiently for specific kinases to phosphorylate the EIIA^{Glc}. Phosphorylated EIIA^{Glc} then undergoes an allosteric change and dissociates from the lactose permease, making it active so that more lactose can enter the cell.

Glucose is normally transported into the cell by a phosphoenolpyruvate (*PEP*)-dependent *phosphotransferase* system (*PTS*). *PTS* is a *phosphorylation cascade* that is activated when glucose levels are low, and the last kinase in the cascade would act to phosphorylate EIIA^{Glc}. High glucose levels blocking lactose entry into the cells, effectively preventing allolactose formation and the derepression of the lac operon.

4. Repressor Protein Structure and Additional Operator Sequences!

The lac repressor is a tetramer of identical subunits (below) and each subunit contains a helix-turn-helix motif capable of binding to DNA.

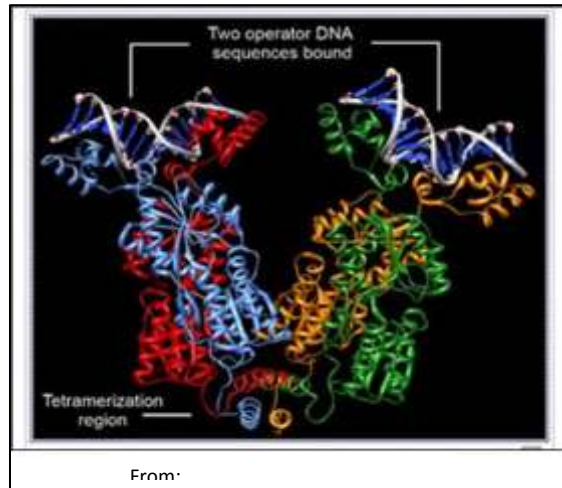

However, the operator DNA sequence consists of a pair of *inverted repeats* spaced apart in such a way that they can only interact two of the repressor subunits, leaving the function of the other two subunits unknown... that is, until recently...!

Two more operator regions were recently characterized in the lac operon. One, called O_2 , is within the *lac z* gene itself and the other, called O_3 , lies near the end but within the *lac I* gene. Apart from their unusual location within actual genes, these operators, which interact with the remaining two repressor subunits, remained undetected because mutations in the O_2 or the O_3 region individually do not contribute substantially to the effect of lactose in derepressing the lac operon. Only if both regions are mutated at the same time is a substantial reduction in binding of the repressor to the operon.

B. Mechanism of Control of the Tryptophan Operon

If ample tryptophan (*trp*) is available, the tryptophan synthesis pathway can be inhibited in two ways. First, recall how feedback inhibition by excess tryptophan can allosterically inhibit the *trp* synthesis pathway. A rapid response occurs when tryptophan is present in excess, resulting in feedback inhibition by blocking the first of 5 enzymes in the tryptophan synthesis pathway. The polypeptides that make up two of these enzymes are encoded by the *trp operon*.

Enzyme 1 is a *multimeric* protein is made from polypeptides encoded by the *trp5* and *trp4* genes. **Enzyme 3** is made up of the *trp1* and *trp2* gene products. When tryptophan levels are low because the amino acid is being consumed (e.g. in protein synthesis), *E. coli* cells will continue to synthesize the amino acid (illustrated below):

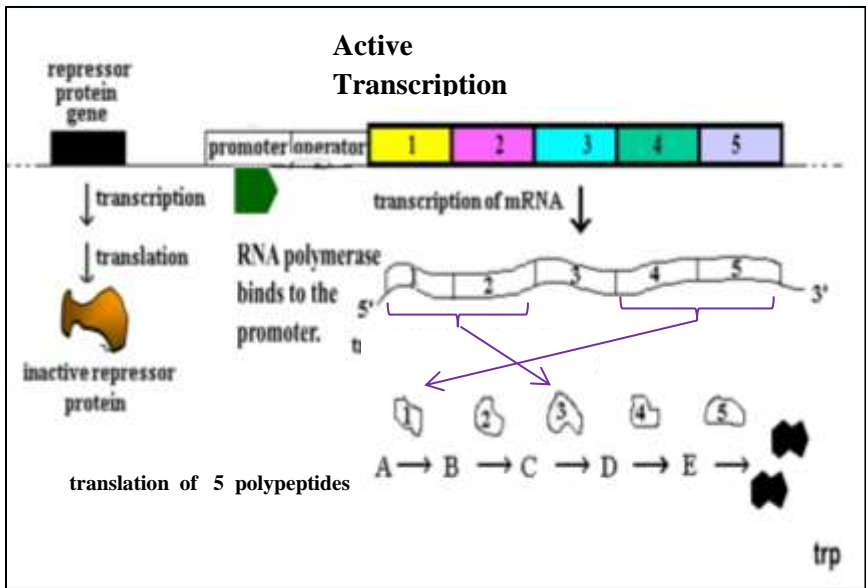

On the other hand, if the environment is high in tryptophan, or if the cell slows down its use of the amino acid, trp accumulates in the cytoplasm where it will bind to the trp repressor. The trp-bound repressor can now bind to the trp operon operator sequence and block RNA polymerase from transcribing the operon, as shown below:

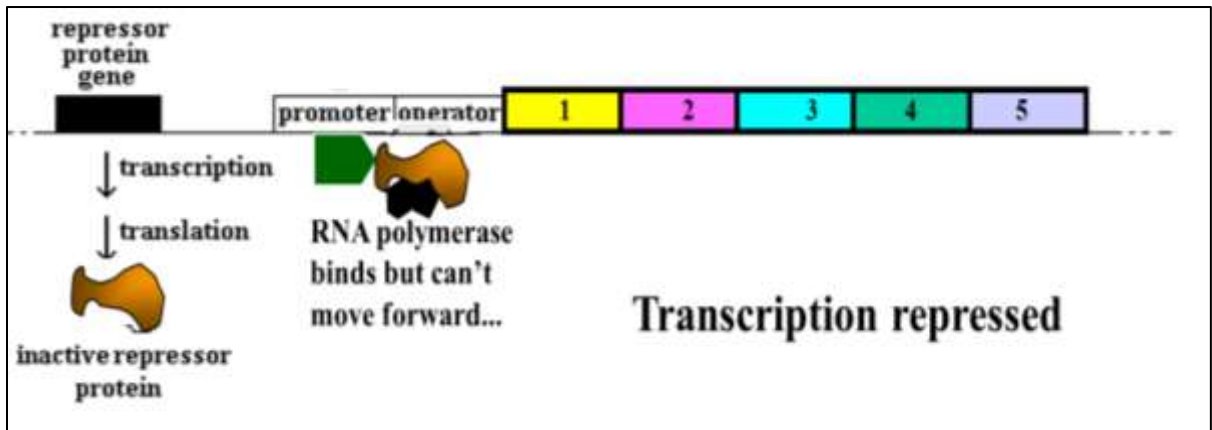

In this scenario, tryptophan is described as a **co-repressor**, whose function is to bind to the repressor protein and change its conformation so that it can bind to the operator.

III. *The Problem with Unregulated (Housekeeping) Genes in All Cells*

Before we turn our attention to the regulation of gene expression in eukaryotes, consider for a moment the expression of constitutive genes. These genes express products (ribosomal proteins, glycolytic and respiratory enzymes, etc.) that must be present at all times in the cell. But here is the problem: these proteins represent sets of many polypeptides that must form large macromolecular complexes like the ribosomal subunits, or must be present in stoichiometrically reasonable amounts to ensure the optimal function of a biochemical pathway, or a series of related pathways such as respiration. If the synthesis of these proteins were not coordinated in some way, the cells in theory at least, might overproduce one or some of these proteins to excess. This would seem to be a waste of energy; as you may recall, protein synthesis is one of the most energy-intensive acts of a cell, each peptide bond costing 3 NTPs. However, recent studies suggest that expression of *housekeeping genes* is not at all coordinated! Still, cells are nonetheless successful in creating the complex structures and biochemical pathways vital to their everyday function and survival. Now back to our focus on regulated gene expression... in eukaryotes.

IV. Gene Regulation in Eukaryotes

A. The Difference between Eukaryotic and Prokaryotic Gene Regulation

Every cell in any multicellular eukaryotic organism contains the same DNA (genes) as every other cell. Here is the proof:

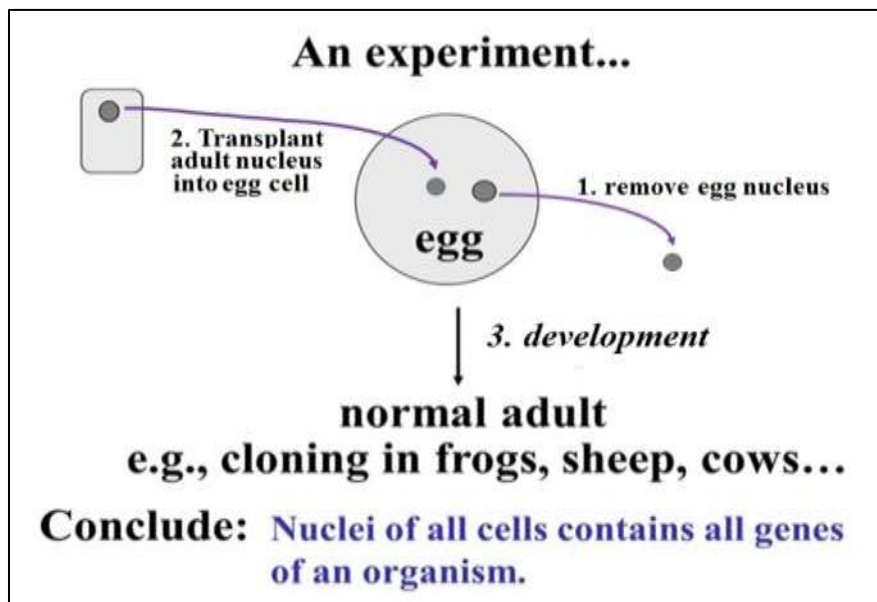

Therefore what makes one cell type different from another is which set of genes is expressed in each. Looked at another way, different cells contain different sets of proteins. The cells can control their metabolic state by controlling how much of each protein they make at a given moment. This accounts for how cells with the same genetic makeup can produce a different set of gene products and look and function so differently. Compared to prokaryotes, eukaryotes have many steps between transcription of an mRNA and the accumulation of a polypeptide end-product. 11 of these steps are shown in the pathway of eukaryotic gene regulation below.

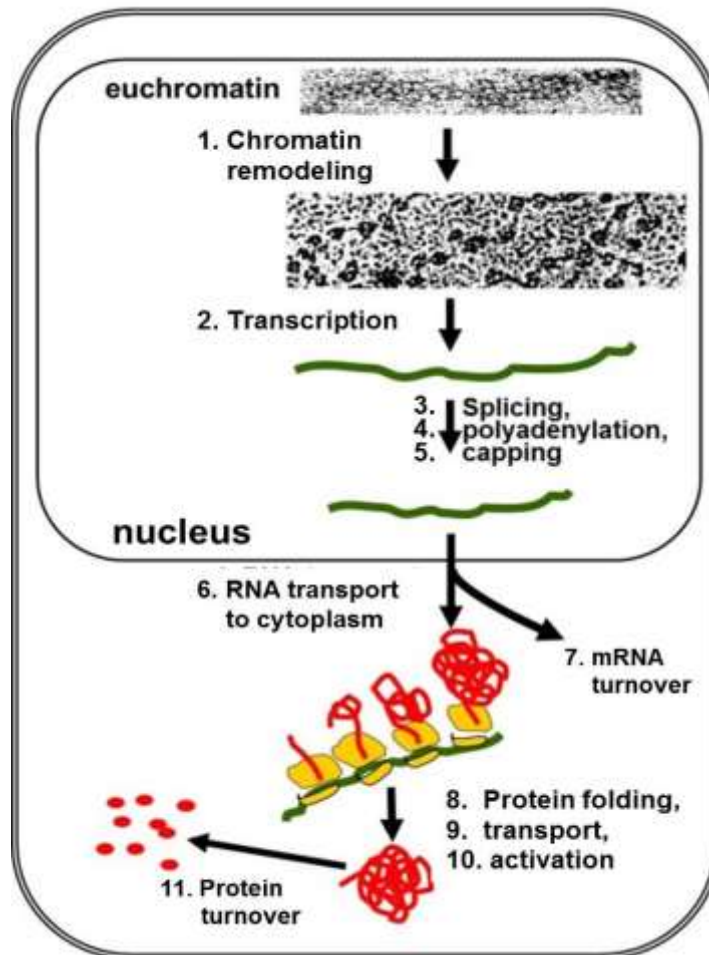

Theoretically, cells could regulate any one or multiple steps in this process, thereby affecting the steady state concentration of a polypeptide in the cells. While regulation of any of these steps is possible, the expression of a single gene is not typically controlled at more than a few steps. A common form of gene regulation is at the level of transcription initiation, turning genes on or off, similar to transcriptional control in bacteria.

B. Complexities of Eukaryotic Gene Regulation

Gene regulation in eukaryotes is more complex than in prokaryotes because a typical eukaryotic genome is thousands of times larger than those of bacteria, because the activity of many more genes must be coordinated without the benefit of multigene codons, and not least because all of the nuclear DNA is wrapped in protein in the form of chromatin. What all organisms share is that they use regulatory proteins that bind to specific DNA sequences (***cis regulatory elements***) to control when a gene is transcribed and when it is not.

Enhancers are DNA sequences that recognize and bind to regulatory proteins to increase the rate of gene transcription. They can be either in the 5' or 3' non-translated region of the gene or even within introns, as illustrated below:

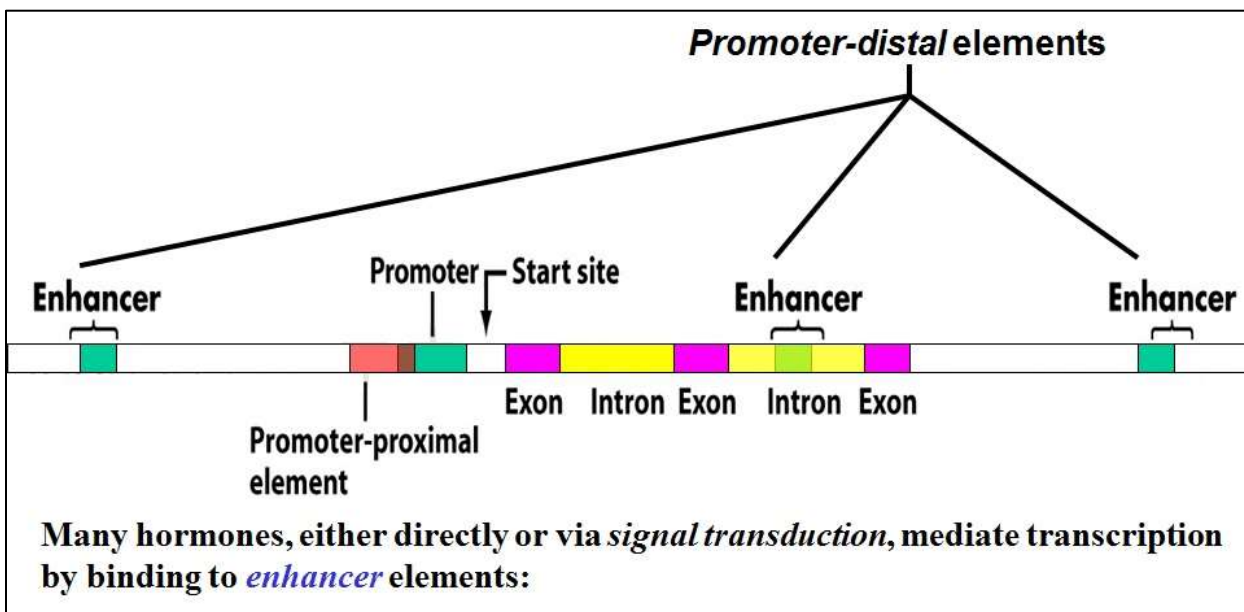

Because enhancers are often thousands of base-pairs away from the genes they control, they are referred to as *distal regulatory elements*. This term applies even to enhancer elements in introns, which can be very far from the start-site of transcription of a gene.

The upstream regulatory regions of eukaryotic genes can often have distal binding sites for more than a few transcription factors, some with positive and others with negative effects. Of course, which of these DNA regions are active in controlling a gene depends on which regulatory proteins are present in the nucleus. Sets of positive regulators will work together to coordinate and maximize gene expression when needed, and sets of negative regulators will bind negative regulatory elements to silence a gene.

The interaction of eukaryotic transcription factors with distal enhancer DNA sequences typically causes DNA to bend. Like the effect of the CAP protein in *E. coli*, bending the DNA loosens H-bonds between bases and also brings enhancer DNA regions close to the transcription initiation complex at a gene promote, making it easier to unwind the DNA. The interactions of enhancer-bound regulatory factors (activators) are illustrated below.

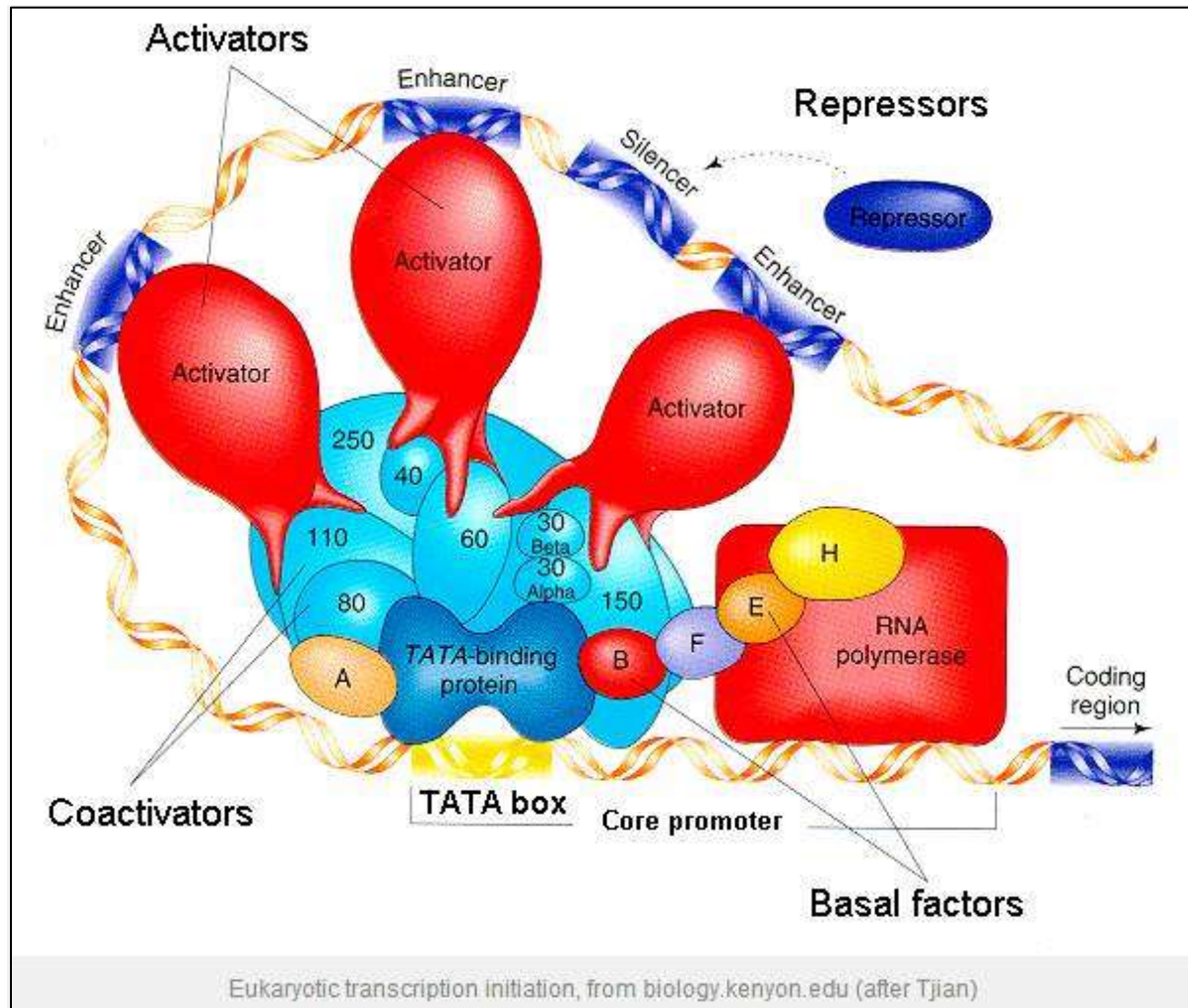

Regulatory proteins, here called *activators* (i.e., of transcription), bind to their enhancers, acquiring an affinity for protein *cofactors* that enable recognition and binding to proteins in the *transcription initiation complex*. This is the attraction that causes DNA to bend and make it easier for RNA polymerase to initiate transcription.

It's worth reminding ourselves that in DNA-protein interactions, as in any interactions of macromolecules, it is shape and allosteric change that allows those interactions. The lac repressor we saw earlier is a transcription factor with *helix-turn-helix* DNA binding motifs.

This and two other motifs that characterize DNA binding proteins (*zinc finger*, and *leucine zipper*) are illustrated below:

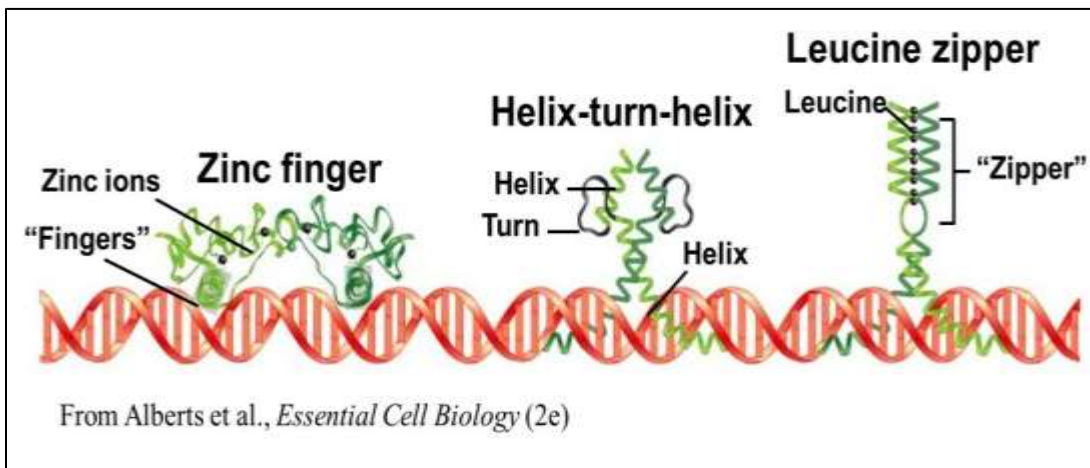

DNA-binding motifs in each regulatory protein in the illustration can be seen binding one or more regulatory elements 'visible' to the transcription factor in the major groove of the DNA double helix.

We'll look next at some common ways in which eukaryotic cells are signaled to turn genes on, increase or decrease their rates of transcription, or completely turn them off. As we describe these models, remember that eukaryotic cells regulate gene expression in response to changing environments as well as by the clock, i.e., dictated by program of gene expression during development. Environmental response usually means response to changes in blood and extracellular fluid composition (ions, small metabolites) that are not on a schedule and are not predictable. Developmental changes are typically mediated by the timely release of chemical signals (hormones, cytokines, growth factors, etc.) by cells. We'll focus on the better understood models of gene regulation by these chemical signals.

C. Regulation of Gene Expression by Hormones that Get into Cells and Those that Don't

Gene-regulatory elements in DNA (so-called *cis-acting elements*) and the transcription factor proteins that bind to them co-evolve. But not only that! Organisms have evolved complete pathways that lead to appropriate regulation. These pathways begin with environmental cues or programmed developmental signals. Environmental chemicals are the main signals to regulate genes in prokaryotes. Chemicals released by some cells that signal other cells to respond are the dominant gene regulatory pathway in eukaryotes. Well-understood examples of the latter include hormones which are released by cells in endocrine glands and then affect *target cells* elsewhere in the body.

1. How Steroid Hormones Regulate Transcription

Steroid hormones cross the cell membranes to have their effects.

CHALLENGE: How do you imagine steroid hormones (which are largely hydrophobic) get past the hydrophilic cell surface before they can pass through the fatty acid interior of the membrane on their way into a cell? You can wonder the same about some steroid hormones whose receptors are already in the nucleus rather than the cytoplasm?

Common ones are testosterone, estrogens, progesterone, glucocorticoids and mineral corticoids. Once in the cytoplasm, steroid hormones bind to a receptor protein to form a steroid hormone-receptor complex that can enter the nucleus and bind to those cis-acting regulatory elements (typically DNA sequences that function as *enhancers*, but also as *silencers*). The basic events are illustrated below.

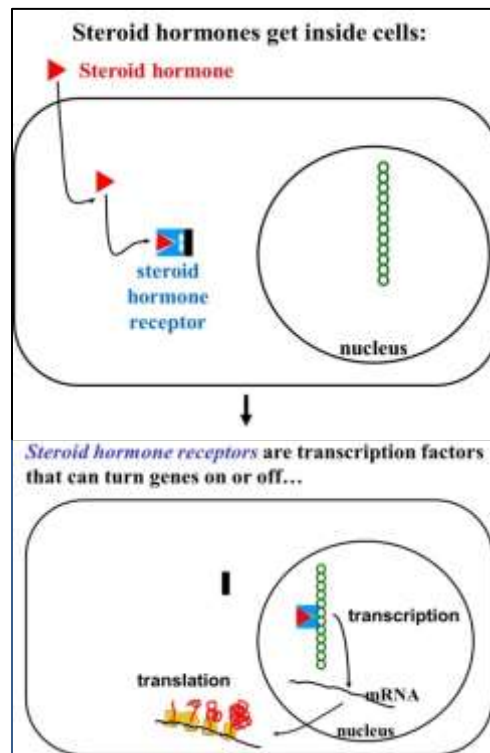

Here the steroid (the triangle) enters the cell. When binding to the steroid hormone receptor (shown as blue and black polypeptide subunits in the cytoplasm), there is a

conformational change in the receptor and the 'black' protein subunit dissociates from the hormone-receptor complex, which then enters the nucleus. The black protein is called Hsp90, or *heat shock* protein 90, a protein of 90,000Da *molecular weight*.

The fascinating thing about Hsp90 and other *heat shock* proteins is that they were originally discovered in cells subjected to heat stress. When the temperature gets high enough, cells shut down most transcription and make instead special *heat shock* transcripts and proteins. These proteins seem to protect the cells against metabolic damage until temperatures return to normal. Since most cells never experience such high temperatures, the evolutionary significance of this protective mechanism and of the existence of heat shock proteins was unclear. But as we can see, heat shock proteins do in fact have critical cellular functions, in this case blocking the DNA-binding site of the hormone receptor until a specific steroid hormone binds to it.

Back to hormone action! No longer associated with the Hsp90 protein, the receptor bound to its hormone *cofactor* binds to a transcription control element (a nucleotide sequence *cis element*) in the DNA, turning transcription of a gene on or off. The process is animated here: <http://youtu.be/G590s9xZ9VA>. The hormone receptors for some steroid hormones are already in the nucleus of the cell, so the hormone has to cross the plasma membrane and the nuclear envelope to access the receptor.

In looking at glycolysis and respiration (energy metabolism), we saw that glucocorticoids turn on the genes of gluconeogenesis. Among other things, steroid hormones control sexual development and reproductive cycling in females, salt and mineral homeostasis in the blood, metamorphosis in arthropods, etc..., all by regulating gene expression.

2. How Protein Hormones Regulate Transcription

Protein hormones are of course large and soluble, with highly charged surfaces. Therefore they can't cross the phospholipid membrane barrier to get into cells. To have any effect at all, they must bind to receptors on the surface of cells. These receptors are typically membrane glycoproteins. The information (signals) carried by protein hormones must be conveyed into the cell indirectly. This process is called *signal transduction*. There are two well-known pathways of signal transduction, each of which involves activating pathways of protein phosphorylation in cytoplasm that eventually results in activation of a transcription factor that binds to regulatory DNA and either turns a gene on or off.

Some protein hormones bind to cell membrane receptors that after undergoing allosteric change, activates other membrane proteins. The net effect is to increase

intracellular concentrations of a cytoplasmic 2nd messenger. cAMP mediates many hormonal responses, controlling both *gene activity* and *enzyme activity*. In this case, cAMP binds to a *protein kinase*, the first of several in a pathway (called a *phosphorylation cascade*). The last in the series of proteins to be phosphorylated is an activated transcription factor that can turn on a gene (below).

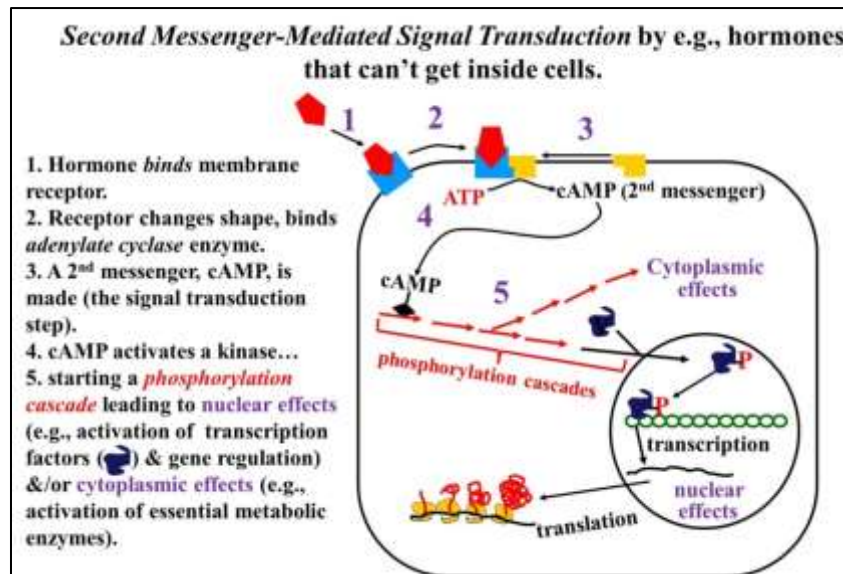

The other kind of signal transduction, shown below, involves a hormone receptor that is itself a protein kinase (below).

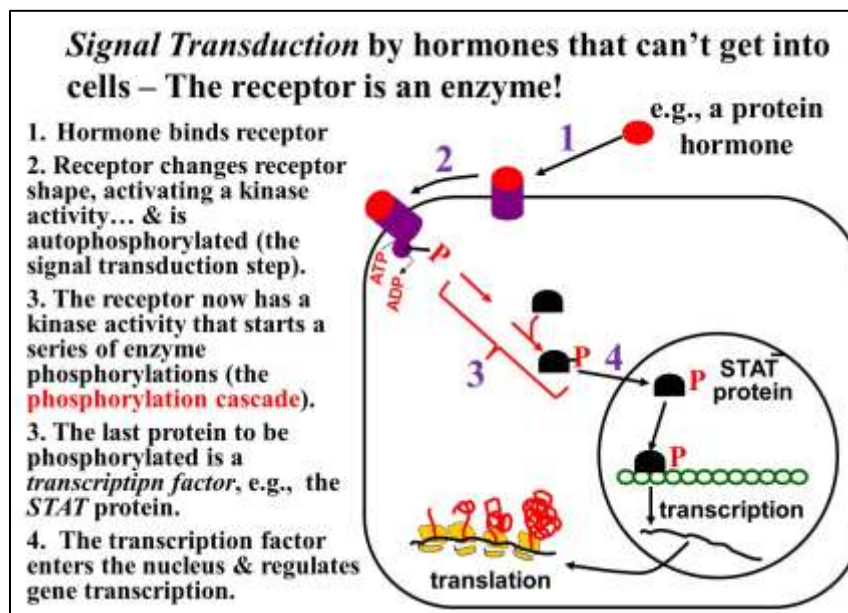

Binding of the signal protein (e.g. hormone) to this kind receptor causes an allosteric change that activates the kinase, starting phosphorylation cascade resulting in an active transcription factor. These two kinds of signal transduction are animated at this link: <http://youtu.be/CSvNSm7pqyc>

We'll be looking at signal transduction in greater detail in a later chapter.

V. Regulating Eukaryotic Genes Means Contending with Chromatin

Consider again the illustration of the different levels of chromatin structure (below).

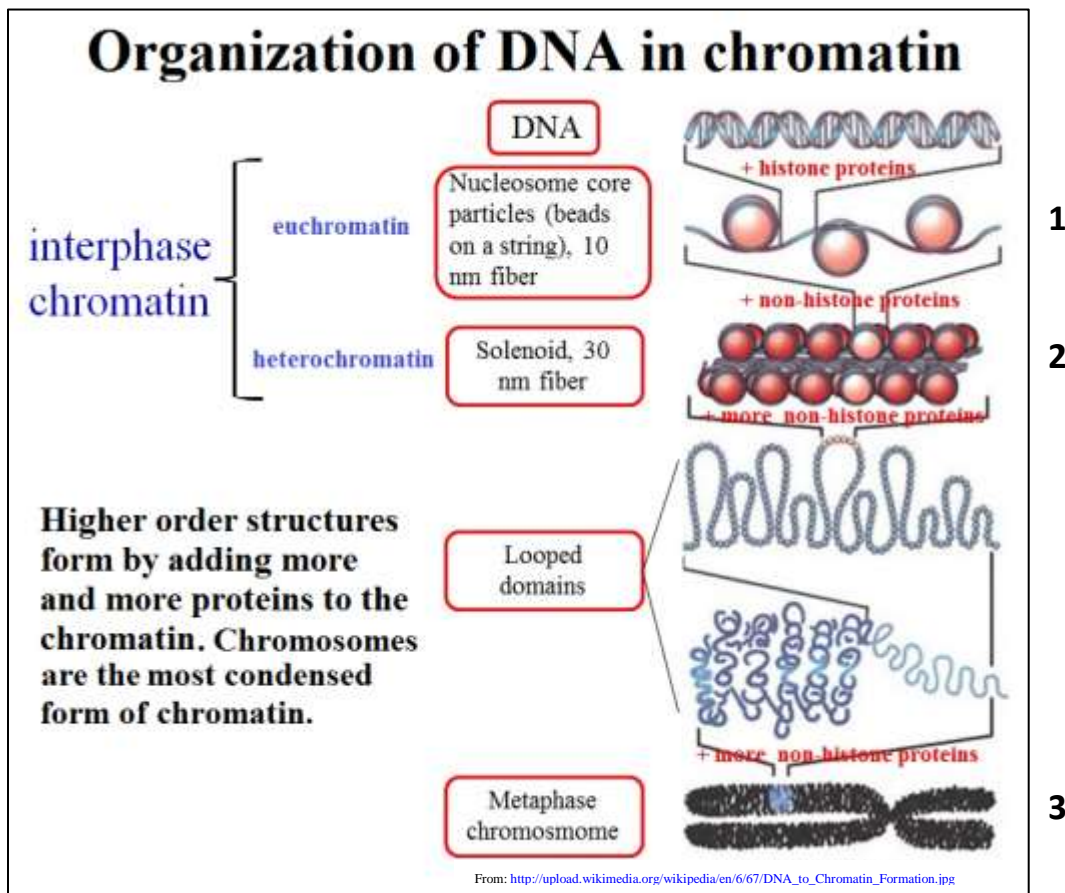

Transcription factors bind specific DNA sequences by detecting them through the grooves (mainly the major groove) in the double helix. But the drawing above reminds us that unlike the nearly naked DNA of bacteria, eukaryotic (nuclear) DNA is dressed with proteins that in aggregate are greater than the mass of the DNA they cover. The protein-DNA complex of the genome is of course, chromatin.

DNA coated with histone proteins form a 9 nm diameter *beads on a string* necklace-like structure, in which the beads are called **nucleosomes**. The association of specific non-histone proteins causes the nucleosomes to fold over on themselves to form the **30 nm solenoid**. Further accretion of non-histone proteins leads to more folding and the formation of the **euchromatin** and **heterochromatin** characteristic of chromatin in non-dividing cells. In dividing cells, the chromatin is further *condensed* to form the **chromosomes** that will be separated during either *mitosis* or *meiosis*.

As we saw earlier, it is possible to selectively extract chromatin. Take a second look at the results of a typical extraction of chromatin from isolated nuclei below.

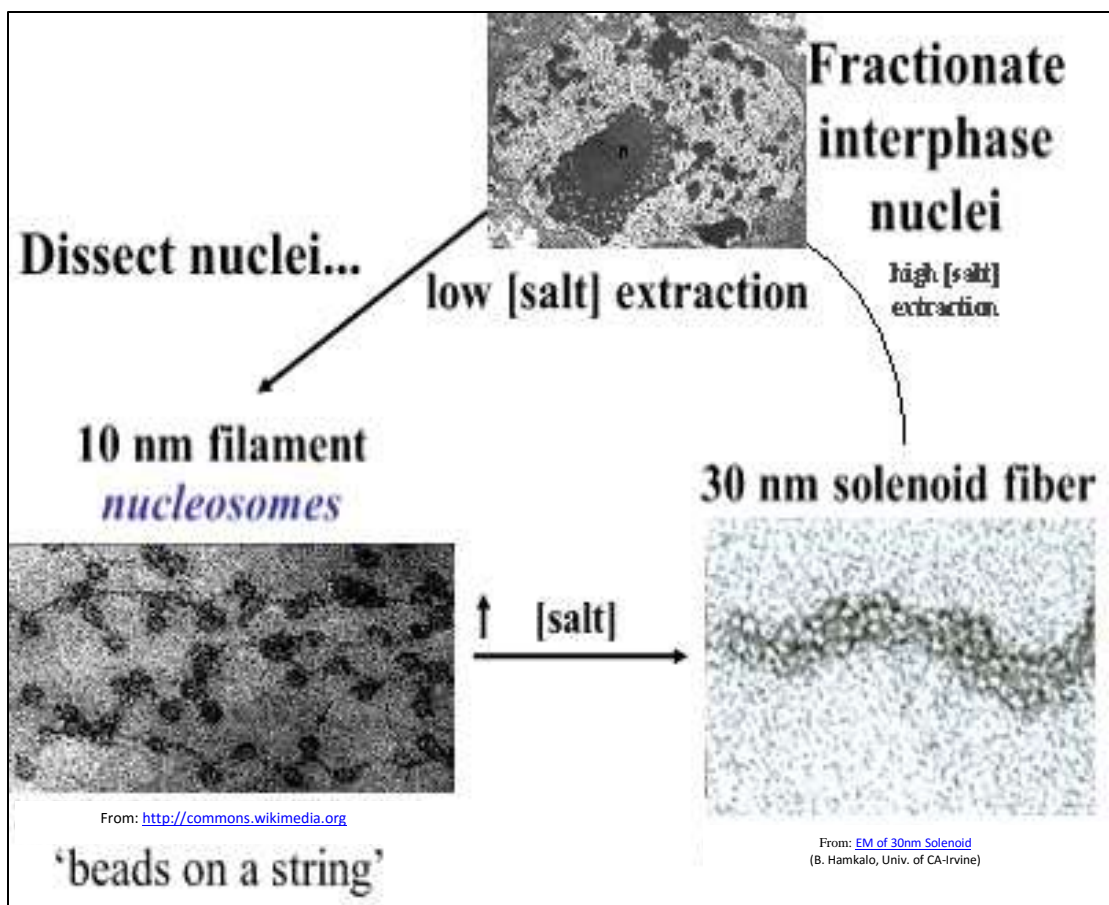

Recall that biochemical analysis of the 10 nm filament (nucleosome) extract revealed that the DNA was wrapped around histone protein octamers, the nucleosomes or beads in this beads-on-a-string structure. The histone proteins are highly conserved in the evolution of eukaryotes (they are not found in prokaryotes). They are also very basic (many *lysine* and *arginine* residues) and therefore very positively charged. This explains why they seem to arrange themselves uniformly along DNA, binding to the negatively charged *phosphodiester backbone* of DNA in the double helix.

Experiments in which total nuclear chromatin extracts were isolated and treated with the enzyme deoxyribonuclease (DNase) revealed that the DNA in active genes was degraded more rapidly than non-transcribed DNA. The interpretation is that active genes are more accessible to DNase because they are in chromatin that is less coiled, less condensed. DNA in more condensed chromatin is surrounded by more proteins and therefore less accessible to the enzyme. Thus the proteins in the more coiled DNA protect the DNA from DNase attack. Genes packed up in chromosomes are of course inactive. Therefore regulating gene transcription must involve changing the shape of chromatin (*chromatin remodeling*) in order to silence some genes and activate others.

Changing chromatin conformation involves chemical modification of chromatin proteins and DNA. For example, chromatin can be modified by histone acetylation, de-acetylation, methylation and phosphorylation, reactions catalyzed by histone acetyltransferases (HAT enzymes), de-acetylases, methyl transferases and kinases, respectively. For example, acetylation of lysines near the amino end of histones H2B and H4 tend to unwind nucleosomes and open the underlying DNA for transcription. De-acetylation then, promotes condensation of the chromatin in the affected regions of DNA. This is illustrated below.

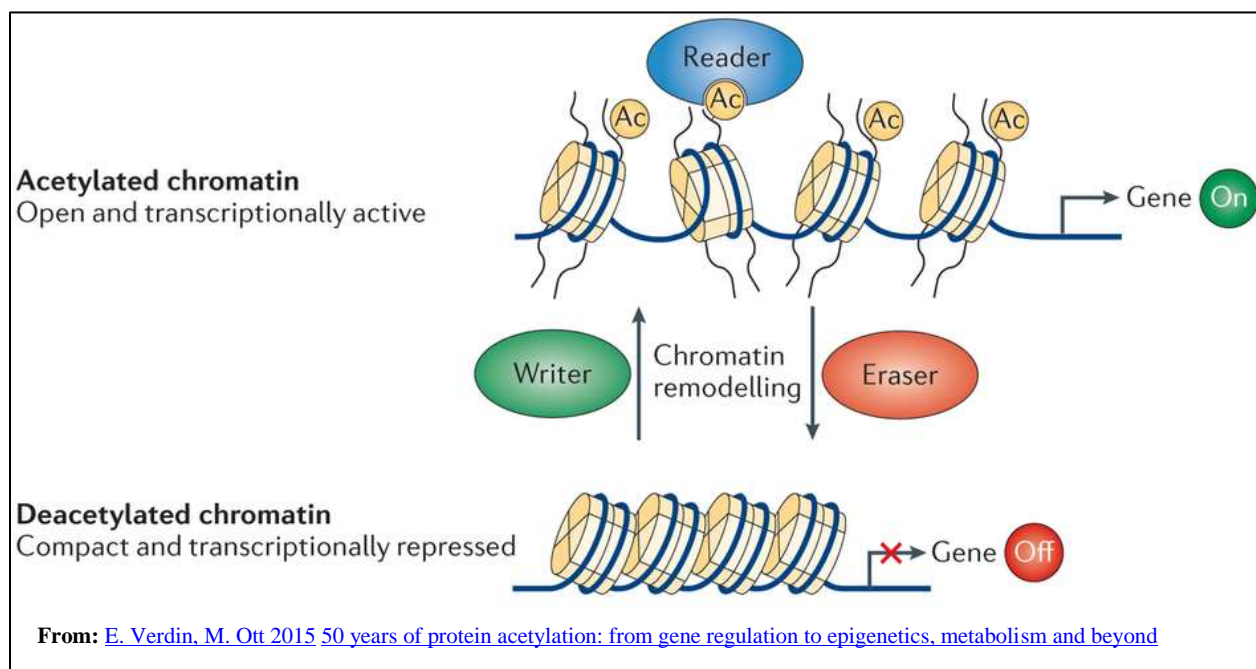

Likewise, methylation of lysines or arginines (the basic amino acids that characterize histones!) of H3 and H4 can open DNA for transcription, while demethylation has the opposite effect. In one case, di-methylation of a lysine in H3 can suppress transcription. These chemical modifications affect recruitment of other proteins that ultimately activate or block transcription.

CHALLENGE: How do you imagine the enzymes that acetylate, methylate, de-acetylate and de-methylate recognize which histones to attack?

Nucleosomes themselves can be moved, slid and otherwise repositioned by ATP-dependent complexes that hydrolyze ATP for energy to accomplish the physical shifts. Some cancers are associated with mutations in genes for proteins involved in chromatin remodeling, no doubt because failures of normal remodeling could adversely affect normal cell cycling and normal replication. In fact, a single, specific pattern of methylation may *mark* DNA in multiple cancer types (check out [Five Cancers with the Same Genomic Signature - Implications](#))

VI. [Epigenetics](#) (Click to see Wikipedia's description)

Epigenetics means *around* or *above* (**epi**) genes. The original use of the term dates from before we knew that DNA was *the stuff of genes*. The idea was that genetic information was pretty stable. Therefore, differences between individuals with the same genes would result from differences in environmental chemical influences on otherwise similar genes. Simply put, genes are affected by time of life as well as by how and where an individual organism lives. The term *epigenetic* has the same meaning today, except that we know that DNA is the stuff of genes, and that genes are indeed influenced by the chemicals around them.

The field of epigenetics looks at protein interactions in eukaryotes that affect gene expression. These interactions change the structure NOT of genes (or DNA), but of the proteins (and other molecules) that affect how DNA and genes are used. As we have seen, the control of transcription involves transcription factors that recognize and bind to regulatory sequences in DNA such as enhancers or silencers. These protein-DNA interactions often require selective structural changes in the conformation of the chromatin surrounding genes. These changes can be profound, stable and not easily undone.

An example of epigenetics is the inheritance of changes in the chromatin proteins that accompany changes in gene expression during development. Given an appropriate signal, say a hormone at the right time, a few cells respond with chromatin rearrangements and the expression of a new set of genes. The new pattern of gene expression characterizes a cell that has differentiated. When this cell divides, its newly differentiated state will then be passed on to new generations during development. From the fertilized egg to the fully mature eukaryotic organism there are hundreds of such changes. And every one of these changes in a particular cell are passed on at mitosis to generations of future cells, accounting for different tissues and organs in the organism. Hence, the many different *epigenomes* representing our differentiated cells are *heritable*.

To sum up, epigenetics is the study of when and how undifferentiated cells (embryonic and later, adult stem cells) acquire their epigenetic characteristics and then pass on their epigenetic information to progeny cells. But what's really interesting (and not a little scary) is that the epigenome can be passed not only from cell to cell, but meiotically from generation to generation. To understand what's going on here, start with this brief history of our changing understanding of evolution:

- Jean-Baptiste Lamarck proposed (for instance) that when a giraffe's neck got longer so that it could reach food higher up in trees, that character would be inherited by the next giraffe generation. According to Lamarck, evolution was *purposeful*, with the goal of improvement.
- Later, Darwin published his ideas about evolution by *natural selection*, where nature selects from pre-existing traits in individuals (the raw material of evolution). The individual that just randomly happens to have a useful trait then has a survival (and reproductive) edge in an altered environment.
- After Mendel's genetic experiments were published and then rediscovered, it became increasingly clear that it is an organism's genes that are inherited, passed down the generations, and that these genes are the basis of an organism's traits.
- By the start of the 20th century, Lamarck's notion of purposefully acquired characters was discarded.

And now we are faced with the possibility of inheritance other than from the DNA blueprint. What does this mean? It means that in addition to passing on DNA (that is, the genes of a male and female parent), epigenomic characteristics (which genes are expressed and when they are expressed) would also be passed to the next generation. But does this make Lamarck right after all? Is it possible that epigenetic information is inherited? And if so, is it purposeful evolution? Is there in fact an *epigenetic code*!? Consider demographic and health record data collected by a doctor in a town in Sweden that kept meticulous harvest, birth, illness and death records.

From the data (below), it's as if the environment was indeed causing an *acquired change* in the grandparent that is passed not to one, but through two generations... and in a sex-specific way! It looked as if environment was influencing inheritance! The table below shows the data from the Swedish physician.

Grand-parent	Food supply	Grandson relative risk of death from cardio disease and diabetes	Granddaughter relative risk of death from cardio disease and diabetes
Grandfather	poor	-35%	No change
Grandfather	abundant	+67%	No change
Grandmother	poor	No change	-49%
Grandmother	abundant	No change	+113%

CHALLENGE: In your own words, use the data in this table to summarize what the numbers in the table mean for the grandchildren of grandparents who grew up in hard times.

This phenomenon was subsequently demonstrated experimentally with already pregnant rats exposed to a toxin. The rat pups born to exposed mothers suffered a variety of illnesses. This might be expected if the toxic effects on the mother were visited on the developing pups, for example through the placenta. But when the diseased male rat pups matured, they were mated to females, the pups in the new litter grew up suffering the same maladies as the male parent, *even though the pregnant females in this case were NOT exposed to the toxins*. Because the original female was already pregnant when she was exposed, the germ line cells (eggs, sperm) of her litter had not suffered mutations *in utero*. This could only mean that epigenetic patterns of gene expression caused by the toxin in pup germ line cells (those destined to become sperm & eggs) *in utero* were retained during growth to sexual maturity, and were passed on to their progeny, even while gestating in a normal unexposed female.

For some interesting experimental findings on how diet influences epigenetic change in *Drosophila* click [Dietary Change Causes Heritable Change in Drosophila Epigenome](#). For recent evidence for a role of male DNA methylation in trans-generational epigenetic inheritance, check out [More on Epigenetic Inheritance across Generations](#)

These days, the term epigenetics is used to describe heritable changes in chromatin modifications and gene expression. We now know that the epigenetic configurations of chromatin that are most stable include patterns of histone modification (*acetylation, phosphorylation, methylation...*) or DNA (*methylation, phosphorylation...*). Such changes can convert the 30nm fiber to the 10nm 'beads-on-a-string nucleosome necklace... and *vice versa*. Such changes in chromatin (chromatin remodeling) lead to alter patterns of gene expression, whether during normal development or when deranged by environmental factors (abundance or limits on nutrition, toxins/poisons or other life-style choices). The active study of DNA methylation patterns even has its own name, *methylomics*! Check out [Epigenetics Definitions and Nomenclature](#) for more epigenetic nomenclature. So, what is scary about epigenetic inheritance? Can you be sure that your smoking or sugary eating habits won't affect the health of your children or grandchildren?

VII. Post-transcriptional Control of Gene Expression

Not too long ago we thought that the only non-coding RNAs were tRNAs and rRNAs of the translational machinery. But we know now that other RNAs are transcribed and that they play various roles in gene regulation and the degradation of spent cellular DNA or unwanted foreign DNA. A few of these that we encountered in an earlier chapter are discussed in more detail below, along with 'riboswitches', a bacterial mechanism for controlling specific transcript levels.

A. [Small RNAs – miRNA and siRNA](#) (Excerpted and adapted from *The Medical Biochemistry Page*)

Two RNAs that share some steps in their processing and regulatory effects (albeit on different target RNA molecules) are micro RNAs (miRNA) and small interfering RNAs (siRNA). These were first discovered as small RNAs that seemed to interfere with gene expression in *C. elegans*, the small flatworm that has been the subject of numerous molecular studies of growth and development for some time now. The particular attractions of this model organism are that it uses a genome similar in size to the human genome (20,168 genes that code for proteins) to produce an adult worm consisting of just 1031 cells organized into all of the major organs found in higher organisms..., AND that it possible to trace the origins of every single cell in its body!

Here is a drawing of what little more than a thousand cells can look like in a complete animal.

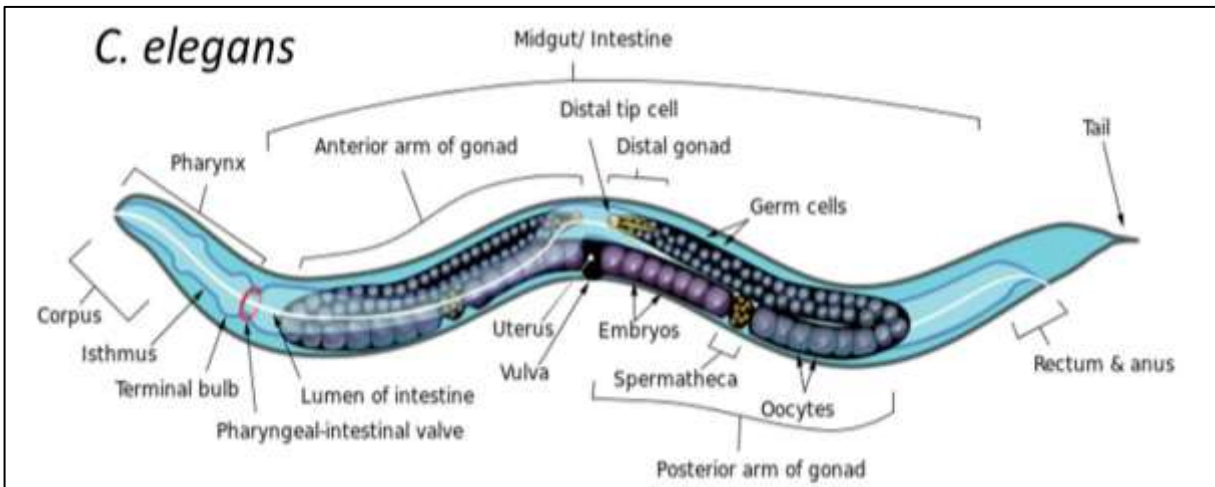

From http://en.wikipedia.org/wiki/Caenorhabditis_elegans

1. *Micro RNAs (miRNA)*

miRNAs are known to be widely distributed in all organisms where they have been sought, where they fold into a hairpin loop when first transcribed. When precursor miRNAs are first transcribed, they fold to form a hairpin loop. They lose the loop when they are processed to make the 'mature' miRNA (below).

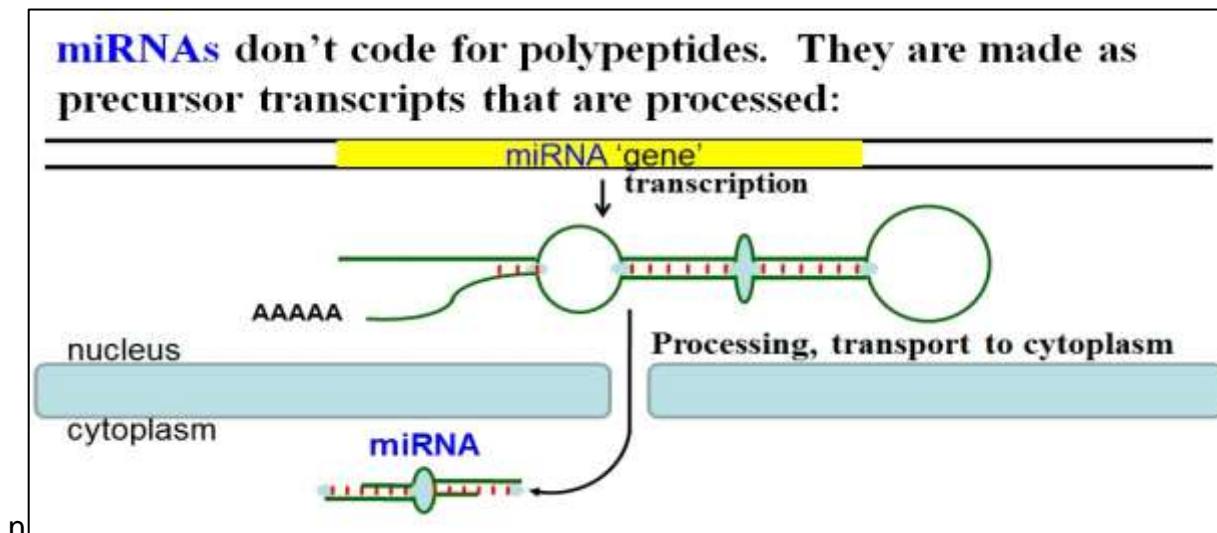

miRNAs cooperate with a protein called RISC to cause degradation of old or no-longer needed mRNAs or mRNAs damaged during transcription. The pathway for processing miRNAs leading to the degradation of target cellular mRNA is animated in the following link: <http://youtu.be/21C01D2Tqeg>. An estimated 250 miRNAs may be sufficient to bind to diverse target RNAs.

2. **Small Interfering RNA (siRNA)**

siRNA was first found in plants and *C. elegans* (perhaps no surprise!), but like miRNAs, siRNAs are common in many higher organisms. They were named because they *interfere* with mRNAs (e.g., the transcription products of viral genomes), and the action of siRNAs was called *RNA interference (RNAi)*. siRNA action during RNA interference is animated in the following link: <http://youtu.be/BTAi3RoSkV0W>. For their discovery of interfering RNA, A. Z. Fire and C. C. Mello shared the 2006 Nobel Prize in Physiology or Medicine.

When foreign double-stranded RNAs (e.g., some viral RNA genomes) get into cells, they are recognized as alien by a *nuclease* called **DICER**. The short double-stranded hydrolysis products of the foreign RNA, the **siRNAs**, combine with *RNAi Induced Silencing Complex*, or **RISC** proteins. The *antisense* siRNA strand in the resulting **siRNA-RISC** complex binds to complementary regions of foreign RNAs, targeting them for degradation.

Custom-designed siRNAs have been used for some time to disable expression of specific genes in order to study their function, and both miRNAs and siRNAs are being investigated as possible therapeutic tools to inactivate genes by RNA interference, whose expression leads to cancer or other diseases.

B. Long Non-Coding RNAs

Until quite recently, we thought that only a few percent (less than 5%) of a typical eukaryotic genome is transcribed into mRNA, with rRNAs and tRNAs making up most of the other transcripts. And even then, only a fraction of the genome was thought to be transcribed in any given cell. Much of the DNA between genes, and even within genes (in the form of introns) was believed to contain *junk DNA* (non-descript sequences, ‘dead’ transposons, etc.) with little or no function. Regulatory DNA surrounding genes and within introns, along with the small RNAs just discussed, intimated that more of the DNA in cells is transcribed than we thought, and that perhaps there is no such thing as “junk DNA” (check out [Junk DNA - not so useless after all](#) for more information). Adding to this re-evaluation of the role of erstwhile non-functional DNA are the recently discovered

long non-coding RNAs (lncRNAs). These can involve as much as 10X more DNA than is required to encode genes, and as we have already seen, includes transcripts of antisense, intronic, intergenic, pseudogene and retroposon DNA.

Some of these long transcripts function in controlling gene expression. A recently discovered, albeit extreme example may be the XistAR gene product, an lncRNA required for production of *Barr bodies* in human female somatic cells which form by inactivating one of the human X chromosomes in humans (see [X-Chromosome Inactivation Requires an lncRNA](#) for more). Also check out a review of lncRNAs (Lee, J.T. 2012. *Epigenetic Regulation by Long Noncoding RNAs*; Science 338, 1435-1439). While some lncRNAs might turn out to be incidental transcripts that the cell simply destroys, others do in fact have a role in gene regulation. An even more recent article (at [lncRNAs and smORFs](#)) summarizes the discovery that some long non-coding contain short open reading frames (*smORFs*) that are actually translated into short peptides of 30+ amino acids! Who knows? The human genome may indeed contain more than 25,000 protein-coding genes!

C. Circular RNAs (circRNA)

Though discovered more than 20 years ago, circular RNAs (circRNAs) are made in different cell types. Click [Circular RNAs \(circRNA\)](#) to learn more about this peculiar result of *alternative* splicing. They were thought at first to be nonfunctional errors of mRNA splicing because they were hard to isolate, and because when they were, they contained “scrambled” exonic sequences. In fact they are fairly stable, and their levels rise and fall in patterns suggesting that they are functional molecules, not merely transcriptional mistakes. For example, the circRNA called *circRims1* rises specifically during neural development. In mice, many circRNAs accumulate during synapse formation, likely influencing how these neurons will ultimately function. Far from being molecular mistakes themselves, *errors in their own synthesis* may be correlated with disease! Speculation on the functions of circRNAs also include a role in the regulation of gene expression (e.g., of the genes or mRNAs from which they are derived).

In spite of these new eukaryotic RNA discoveries, the debate about how much of our genomic DNA is a relic of past evolutionary experiments and without genetic purpose continues. Read all about it at [Only 8.2% of human DNA is functional](#).

D. Riboswitches

Riboswitches are a bacterial transcription mechanism for regulating gene expression. While this mechanism of regulation is not specifically post-transcriptional, it is included here because the action occurs after transcription initiation and aborts completion of an mRNA.

The basis of riboswitch action is illustrated in the example below, showing the regulation of expression of an enzyme in the guanine synthesis pathway below.

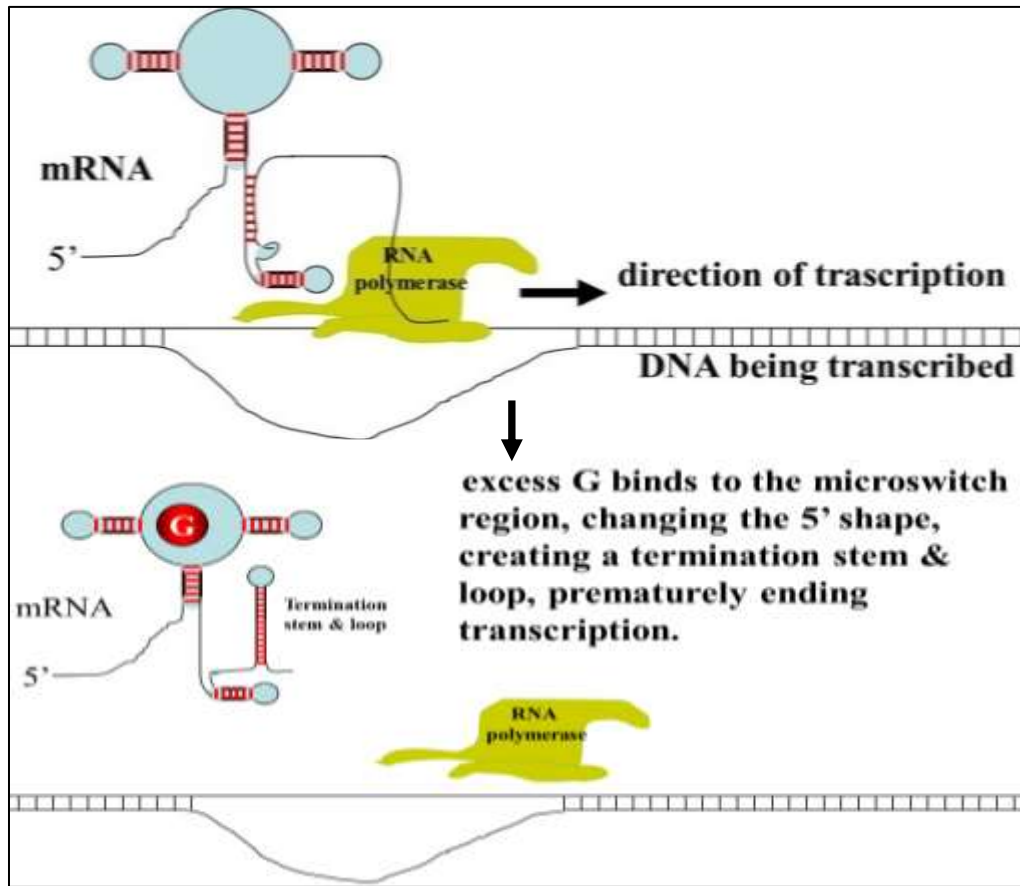

When the base guanine is at low levels in the cells, the mRNA for an enzyme in the guanine synthesis pathway is transcribed (blue & red structure, above left). The transcript itself folds into a stem-&-loop structure. One of these stem-loop elements (near its 5' end) binds guanine when it is in excess in the cell, causing the RNA polymerase and the partially completed mRNA to dissociate from the DNA, prematurely ending transcription.

E. CRISPR: an Array of Genes Transcribed During Prokaryotic Phage Infection

1. CRISPR RNAs are part of a simple but adaptive prokaryotic immune system

CRISPR (Clustered Regularly Interspaced Short Palindromic Repeat) RNAs are derived from phage transcripts that have interacted with CRISPR-Associated (Cas) proteins. CRISPR-Cas is part of an "adaptive" *prokaryotic immune system* found in

prokaryotes. In higher organisms, the *adaptive immune system remembers* prior exposure to a pathogen, and so can mount a response to a second exposure to the same pathogen. Its discovery in many prokaryotes (bacteria, archaeobacteria) was therefore something of a surprise.

When a cell is challenged by phage, phage DNA gets in the cell where it can activate transcription of a CRISPR/Cas gene array in the bacterial genome. *Spacer* DNA separating the CRISPR repeats are derived from earlier phage infections, and so contain sequences complementary to the original infecting phage. To learn more about how bacteria acquire spacer DNAs (and therefore this primitive immune system!) in the first place, check out <https://en.wikipedia.org/wiki/CRISPR>.

If the same phage attempts to re-infect such cells, the *spacer RNAs* and Cas genes will be transcribed. After Cas mRNA is translated, the Cas protein and spacer RNAs will engage and target the incoming phage DNA for destruction, preventing infection. Thus the CRISPR/Cas systems (there is more than one!) *remember* prior phage attacks, and transmit that memory to progeny cells. The CRISPR/Cas gene array consist of the following components:

- **Cas:** Genes native to host cells
- **CRISPR:** 24-48 bp repeats native to host cells
- **Spacer DNA:** DNA between CRISPR repeats: typically phage DNA from prior phage infection or plasmid transformation
- **leader DNA:** Contains promoter for CRISPR/spacer RNA transcription
- **tracr gene:** Encodes transcription activator (tracr) RNA (not all systems)

The CRISPR/Cas9 system, found in *Streptococcus pyogenes*, one of the simplest of these immune defense systems, is illustrated below.

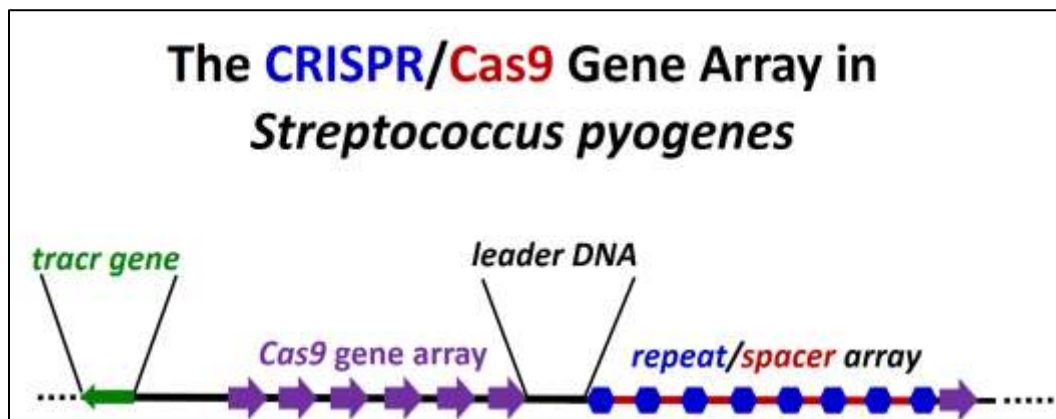

The CRISPR/Cas9 system has been extensively studied and engineered to facilitate gene function and potential gene therapy studies. To appreciate the power of CRISPR/Cas as a tool for molecular studies, consider the mechanism of action of this prokaryotic immune system. The action begins when infectious phage DNA gets into the cell, as drawn below for the CRISPR/Cas9 system.

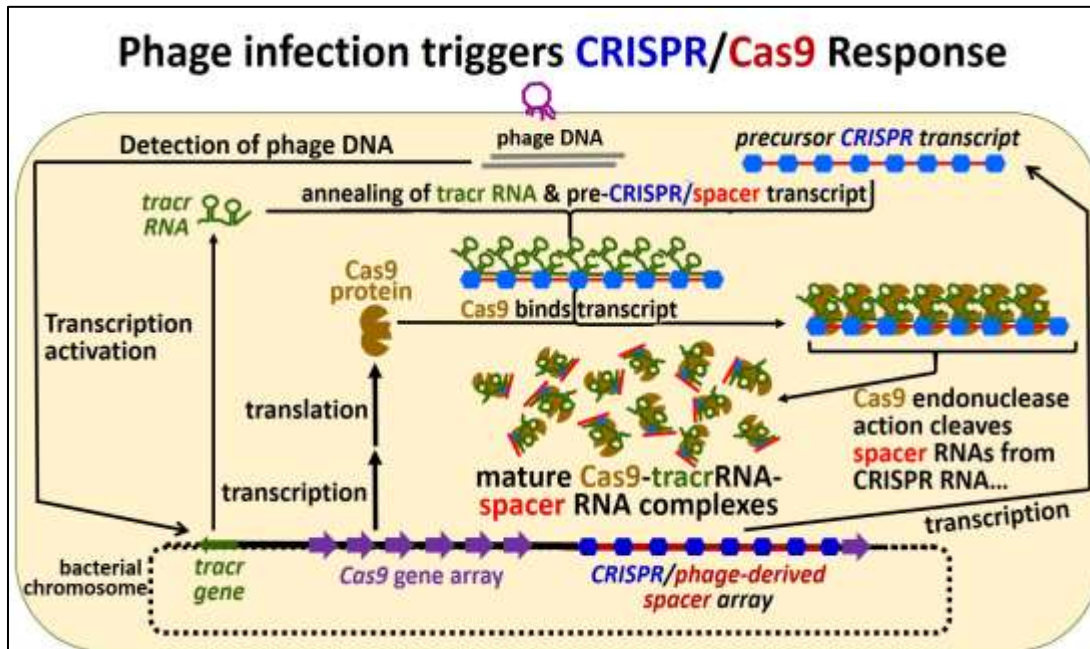

Let's summarize what's happened here so far:

- Incoming phage DNA* was detected after phage infection.
- Then the *tracr* and *Cas* genes are transcribed, along with the *CRISPR/spacer* region. The *Cas* mRNAs are translated to make the *Cas* protein. Remember, the spacer DNAs in the *CRISPR* region are the legacy of a prior phage infection.
- CRISPR/spacer* RNA H-bonds a complementary region of the *tracr* RNA as the two RNAs associate with *Cas* proteins.
- Cas* protein endonucleases hydrolyze spacer RNA from *CRISPR* RNA sequences. The spacer RNAs remain associated with the complex while the actual, imperfectly palindromic *CRISPR* sequences (shown in blue in the illustration above) fall off.

In the next steps, *phage-derived spacer RNA*, now called *guide RNA* (or *gRNA*) 'guide' mature *Cas9/tracrRNA/spacer* RNA complexes to new incoming phage DNA resulting from a phage attack.

The association of the complex with the incoming phage DNA is followed by the events illustrated below.

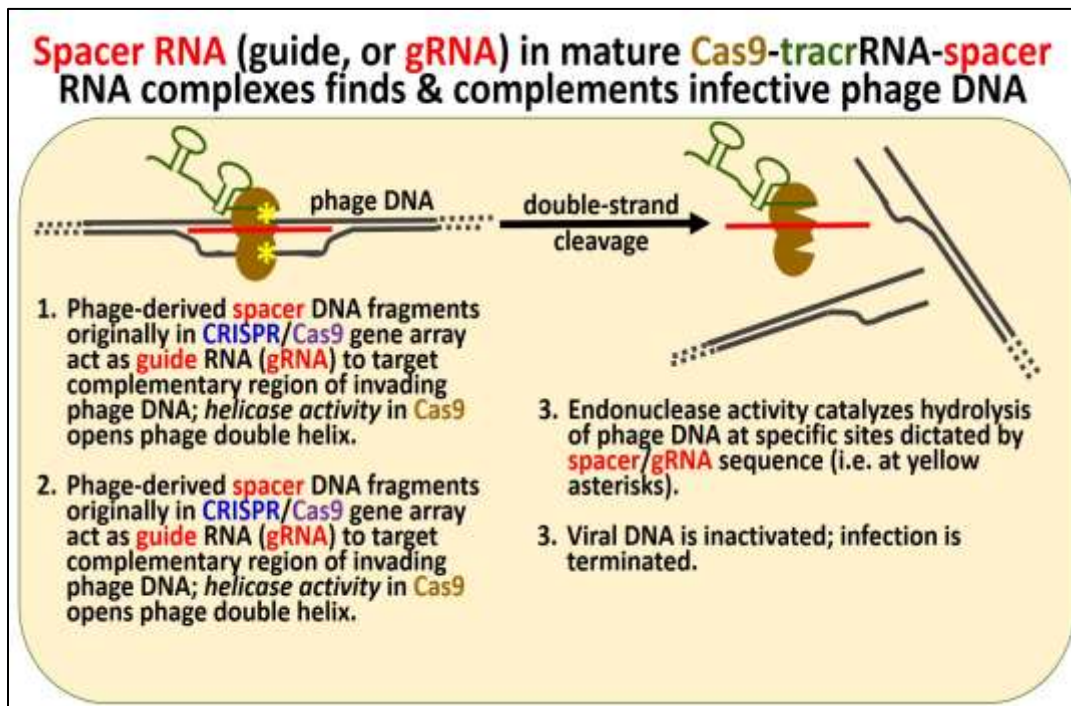

And once again, let's sum up *these* steps:

- Spacer* (i.e., *gRNA*) in the complex targets *incoming phage DNA*.
- Cas helicase* unwinds *incoming phage DNA* at complementary regions.
- gRNA* H-bonds to *incoming phage DNA*.
- Cas endonucleases* create a double-stranded break (hydrolytic cleavage) at *specific sites* in *incoming phage DNA*. Because precise site DNA strand cleavage is guided by RNA molecules, CRISPR/Cas endonucleases are classified as type V *restriction enzymes*.
- The *incoming phage DNA* is destroyed and a new phage infection is aborted.

2. Applications of the CRISPR/Cas System

Early studies demonstrated the reproducible cleavage of incoming phage DNA at specific nucleotides. Several labs quickly realized that it might be possible to adapt the system to cut DNA at virtually any specific nucleotide in a target DNA, *in vitro* or *in vivo*! In fact, the system works both *in vivo* and *in vitro*, allowing virtually unlimited potential for editing genes and RNAs in the test tube... or in **any** cell.

Here is the basic process:

- a) Engineer **gDNA** with a Cas-specific DNA sequence that targets a desired target in genomic DNA.
- b) Fuse the **gDNA** to **tracr DNA** to make a *single guide DNA (sgDNA)* so that it can be made as a single guide transcript (**sgRNA**).
- c) Engineer a **CRISPR/Cas9** gene array that substitutes this *sgDNA* for its original *spacer DNAs*.
- d) Place engineered array in a plasmid next to *regulated promoters*.
- e) *Transform* cells by 'electroporation' (works for almost any cell type!)
- f) *Activate the promoter* to transcribe the CRISPR/Cas9 genes...

The applications are powerful... and controversial!

3. The Power and the Controversy...

The application of gene editing with CRISPR/Cas systems has already facilitated studies of gene function in in vitro, in cells and in whole organisms (click here for a description of CRISPR/Cas applications already being marketed: [CRISPR Applications from NEB](#)). The efficiency of specific gene editing using CRISPR/Cas systems holds great promise for understanding basic gene structure and function, the genetic basis of disease, and for potential to gene therapies. Here are just a few examples of how CRISPR/Cas approaches can be applied.

1. Engineer an sgRNA with desired mutations targeting specific sites in chromosomal DNA. Then clone sgRNA into the CRISPR/Cas9 array on a plasmid. After transformation of appropriate cells, the engineered CRISPR/Cas9 forms a complex with target DNA sequences. Following nicking of both strands of the target DNA, DNA repair can insert the mutated guide sequences into the target DNA. The result is loss or acquisition of DNA sequences at **specific, exact sites**, or **Precision Gene Editing**. It is the ability to do this in living cells that has excited the basic and clinical research communities.
2. Before transforming cells, engineer the **CRISPR/Cas9** gene array on the plasmid to eliminate both **endonuclease** activities from the Cas protein. When transcription of the array is activated in transformed cells, the *CRISPR/Cas9-sgRNA* can still find *sgRNA*-targeted gene, but lacking Cas protein endonuclease activities, the complex that forms will just sit there and **block transcription**. This technique is sometimes referred to as **CRISPRi** (*CRISPER interference*), by

analogy to *RNAi*. Applied to organisms (and not just in vitro or to cells), it mimics the much more difficult **knockout** mutation experiments that have been used in studies of behavior of cells or organisms rendered unable to express a specific protein.

- 3. Precision Gene Editing** (there are several working CRISPR/Cas systems) are exciting for their speed, precision, prospects for rapid and targeted gene therapies to fight disease, and even possibilities to alter entire populations (called **Gene Drive**; Read more at https://en.wikipedia.org/wiki/Gene_drive. By inserting modified genes into the germline cells of target organisms, gene drive could be used to render harmless entire malarial mosquitoes populations, to eliminate pesticide resistance in e.g. insects, eliminate herbicide resistance in undesirable plants, or genetically eliminate invasive species. For an easy read about this process and the controversies surrounding applications of CRISPR technologies to mosquitoes in particular, check out J. Adler, (2016) *A World Without Mosquitoes*. Smithsonian, 47(3) 36-42, 84.

If for no other reason than its efficiency and simplicity, the CRISPR/Cas techniques for editing genes and genomes technique have raised ethical issues because of the potential for abuse, or even for use with no beneficial purpose at all. It is important to note that, as in all controversies about biological experimentation, scientists are very much engaged in the conversation.

VIII. Eukaryotic Translation Regulation: coordinating heme & globin synthesis

This example of gene regulation is clearly post-transcriptional. Consider that *reticulocytes* (the precursors to *erythrocytes*, or red blood cells in mammals) synthesize **globin**, a protein. They also synthesize **heme**, an iron-bound organic molecule. Each globin must bind to a single heme to make a hemoglobin protein subunit. Clearly, it would not do for a reticulocyte to make too much globin protein and not enough heme, or *vice versa*. The reticulocytes use the post-transcriptional mechanism at the following link to ensure that they produce equimolar amounts of globin and heme: <http://youtu.be/Hp00FPV62y0>.

Hemin (a *heme* precursor) binds to a **HCR kinase** in the reticulocytes. This enzyme phosphorylates eukaryotic initiation factor 2 (**eiF2**). *Phosphorylated eiF2* is inactive and prevents the initiation of globin mRNA translation. But if heme production gets ahead of globin, hemin accumulates to excess and binds HCR kinase, blocking eiF2 phosphorylation. The unphosphorylated eiF2 can now participate in the initiation of globin mRNA translation, allowing globin synthesis to catch up with heme levels in the cell.

IX. Regulating protein turnover.

We have already seen that organelles have a finite life span and that they can be replaced by new ones when they no longer function efficiently. Recall that lysosomes participate in destroying worn out mitochondria and their molecular components. Here we consider how cells can target specific cytoplasmic molecules for destruction when they have outlived their usefulness.

The steady-state concentration of any cellular molecule exists when the rate of its synthesis is balanced by the rate of its turnover. For example, the concentration of an mRNA can change if rates of transcription, processing or turnover change. We have seen that the level of gene expression (the amount of a final RNA or protein gene product available on a cell) can be regulated at the level of transcription. Riboswitches in bacteria and miRNAs and siRNAs in eukaryotes appear to be mechanisms to regulate mRNA turnover rate or half-life.

Half-life is defined as the time it takes for half of a specific molecule or evidence of its biological activity to disappear in the absence of new synthesis of the molecule). If one can block the synthesis of the RNA or protein, the half-life of cellular RNAs (and proteins) can often be determined experimentally. By the same rationale, we should expect the steady-state levels (concentrations) of proteins to be regulated by how fast the proteins are produced and how fast they are degraded on cells.

The half-life of different proteins seems to be inherent in their fine structure. In other words, some amino acid side chains are more exposed at the surface of the protein and thus susceptible to change or damage over time than others. Proteins with fewer 'vulnerable' amino acids should have a longer half-life than those with more of them. Proteins damaged by errors of translation, folding, processing gone awry or just worn out from use or 'old age' are chemically targeted for destruction.

The key mechanism for detecting and destroying unwanted proteins involves the interaction the **targeted protein** with a 76-amino acid polypeptide called **ubiquitin** and a large complex of polypeptides called the **proteasome**. This interaction and the formation of the proteasome requires energy from ATP hydrolysis, and the action of several enzymes. Additional enzymes that are part of the structure of the proteasome finally hydrolyze and degrade unwanted old, damaged or misbegotten proteins in the cytoplasm of the cell.

The following illustration details this interaction.

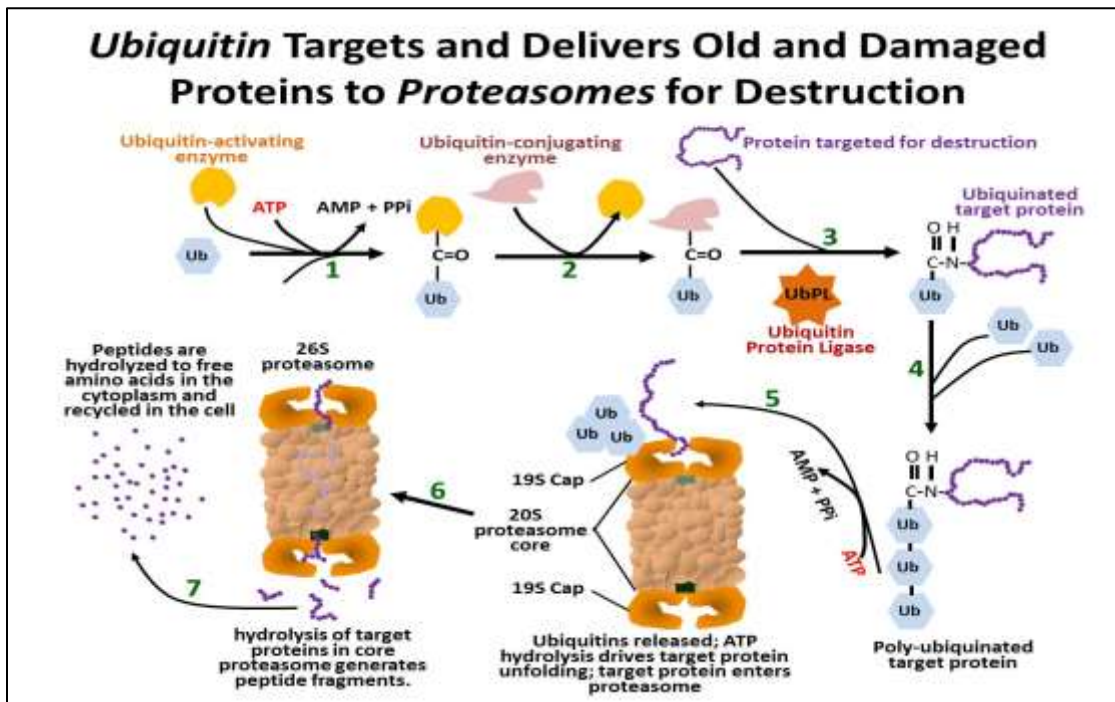

Since there are a mind-boggling variety of proteins in a cell, it turns out that there are also a large number of ubiquitin proteins (there are about 600 ubiquitin genes!). Presumably each ubiquitin handles a subclass of proteins based on common features of their structure. The first step is to activate a ubiquitin. This starts when ATP hydrolysis fuels the binding of ubiquitin to an **ubiquitin-activating enzyme**. In step 2 an **ubiquitin-conjugating enzyme** replaces the ubiquitin-activation enzyme. In step 3 the protein destined for destruction replaces the ubiquitin-conjugating enzyme. Several more ubiquitins bind to this complex (step 4). Then the **poly-ubiquitinated protein** delivers its protein to one of the 'CAP' structures of the proteasome (step 5). After binding to one of the CAP structures of a proteasome, the poly-ubiquitinated target proteins dissociate. The ubiquitins are released and recycled, while the target protein unfolds (powered by ATP hydrolysis). The unfolded protein next enters the proteasome where it is digested to short peptide fragments by proteolytic enzymes in the interior of the proteasome core. The fragments are released from the CAP complex at the other end of the proteasome and digested down to free amino acids in the cytoplasm.

The proteasome complex actually consists of a 20S core and two 19S CAP complexes. With its complex quaternary structure, the 26S proteasome is smaller than a eukaryotic small ribosomal subunit (40S), but is still one of the largest cytoplasmic particles... and without the benefit of any RNA in its structure! Click on this link to see an animated version of the illustration above: <http://youtu.be/q-DQq4XDfw>.

Some iText & VOP Key Words and Terms

10 nm fiber	fully differentiated cells	phage DNA
3' non-transcribed DNA	galactose	phosphodiester backbone
30 nm solenoid fiber	galactoside	phosphorylation cascade
5' non-transcribed DNA	gene activation	pluripotent cells
adaptive immune system	gene derepression	polycistronic mRNA
adult stem cells	gene expression	positive regulation
allolactose	gene induction	promoter
antisense RNA	gene regulation	proteasome
basic v. non-basic proteins	gene repression	protein turnover rates
beads-on-a-string	gRNA	proximal regulatory
β -galactosidase	HAT enzymes	pseudogene
<i>C. elegans</i>	helicase	PTS
cAMP	helix-turn-helix motif	regulatory genes
cAMP receptor protein	hemin	retroposon
CAP protein	heterochromatin	riboswitch
Cas endonuclease	histone acetylation	RISC
Cas helicase	histone kinases	RNA turnover rates
CAT box	histone methyl transferases	RNA-induced silencing complex
catabolite activator protein	histone methylation	RNase III (Drosha)
chromatin remodeling	histone phosphorylation	second messenger
chromatin remodeling	housekeeping genes	sgRNA
Circular RNA	HRC kinase	signal transduction
cis-acting elements	inducer exclusion	siRNA (small interfering
cistron	interphase	small RNAs
condensed chromatin	introns	spacer DNA
CRISPR/Cas	lac operon	steroid hormone receptors
CRISPR/Cas9 gene array	lacI gene	steroid hormones
crRNA	lactose	<i>Streptococcus pyogenes</i>
developmental program	lactose permease	structural genes
dicer	lactose repressor	TATA box
differential gene expression	lacZ, lacY and lacA genes	tetrameric lac repressor

distal regulatory element	leucine zipper motif	totipotent cells
DNA bending	levels of chromatin	tracr gene
DNase	lncRNA	tracr RNA
eiF2 phosphorylation	long non-coding RNAs	transcription factors
EIIA ^{Glc}	major groove	transcription regulation
embryonic stem cells	minor groove	transcription start site
enhancers	miRNA (micro RNA)	translation regulation
environmental signals	negative regulation	trp operon
epigenome	nucleosomes	trp repressor
euchromatin	O ₁ and O ₂ lac operators	ubiquitin
exons	operator	zinc finger motif
exportin	operon regulation	
extended chromatin	PEP-dependent P-transferase system	

Chapter 13: DNA Technologies

Manipulating DNA; cDNA libraries, Genomic Libraries, DNA Sequencing, PCR, Microarrays, Genomics, Transcriptomics, Proteomics



I. Overview

We begin this chapter by looking at seminal **recombinant DNA** technologies that led to what we call **genetic engineering**. First we'll look at **cDNA** (copy DNA) synthesis, a normal process in the pathway of retrovirus reproduction. The retrovirus injects its RNA into target cells where it transcribes a **reverse transcriptase** enzyme. This enzyme then reverse-transcribes a DNA complementary to the viral RNA. Then a double stranded version of this reverse transcript is made that replicates and directs the synthesis of new viral RNAs and viruses. Purified versions of reverse transcriptase can be used to reverse transcribe a copy DNA from virtually any RNA sequence. We'll look at how a **cDNA library** is created and screened for **cDNA clones**, and how cloned cDNAs can be used to fish out the clone of an entire gene from a **genomic library**. We'll also look at the polymerase chain reaction which can be used to produce (*amplify*) millions of copies of a single gene (or other) DNA sequence from as little DNA as is found in a single cell. Apart from its well-publicized use in forensics, PCR remains an important laboratory tool for fetching, amplifying and studying sequences of interest. Traditionally cloned and amplified DNA sequences have been used to study the evolution and expression of individual genes. These venerable technologies serve here to illustrate important principles of cloning and sequence analysis. In recent years cloning and PCR techniques have given way to **Genomics** and **Proteomics**. These newer fields of research leverage a growing battery of technologies to study many genes and their regulation at the same time, allowing us to probe **regulatory networks**. Genomics and Proteomics promise to get us past incomplete and even naïve notions of correlation,

i.e., because a single genetic mutation is correlated with a genetic illness, it is the cause of the illness. We may be soon able to identify *many* likely correlations that sum up to causation or propensity to an illness.

Voice-Over PowerPoint Presentations

[DNA Technologies: cDNA Libraries](#)

[DNA Technologies: DNA Sequencing](#)

[DNA Technologies: Genomic Libraries](#)

[DNA Technologies: The Polymerase Chain Reaction \(PCR\)](#)

[DNA Technologies: Microarrays](#)

Learning Objectives

When you have mastered the information in this chapter and the associated VOPs, you should be able to:

1. Suggest molecular techniques to design experiments to test an hypothesis (e.g., how would you use cDNA or a PCR product to clone a gene)
2. Determine when to make or use a *cDNA library* or a *genomic library*
3. Design an experiment to *purify rRNA* from eukaryotic cells
4. Design an experiment to isolate a cDNA for a human protein and clone it so you can manufacture insulin for the treatment of disease
5. Explain circumstance under which you might want to *clone and express a human growth hormone gene*
6. List the components you will need to make a cDNA library once you have isolated *poly(A) RNA* from cells
7. List the components you will need to make a genomic library once you have isolated *genomic DNA* from cells
8. Compare and contrast the use of PCR to cloning a gene from genomic DNA
9. Choose when to use a *genomic library* and when to use a *microarray* to obtain a gene you want to study
10. Explain and demonstrate the logic of using fly DNA to clone or otherwise obtain copies of a human DNA sequence

II. [Make & Screen a cDNA Library](#) (Click to see Wikipedia's description)

cDNAs are DNAs copied from cellular mRNAs using the enzyme ***reverse transcriptase***.

This is the enzyme that a retroviruses like HIV uses to copy its RNA genome into DNA. It is the copied DNA that will be made double-stranded (by the same reverse transcriptase) that then replicates in an infected cell to make more viruses.

Under ideal conditions of cellular extraction, an mRNA isolate should represent all of the transcripts present and being synthesized in the cell at the time of isolation. Such a collection of mRNAs is referred to as a *cell-specific transcriptome*. This term is used by analogy to genome, except that a genome is all of the genetic information of an organism, while the transcriptome of a (typically eukaryotic) cell, is specific not only to a cell type, but to the particular time or metabolic state of the cells at the time the mRNAs were originally isolated! In this sense, a transcriptome reflects all of the genes being expressed in a given cell type at a moment in time. The cDNAs that can be made and cloned from this mRNA extract may also be referred to as a transcriptome.

A *cDNA library* is a typically a tube full of bacterial cells, each of which contains plasmids that have been recombined with one of the many cDNAs isolated from experimental cells of interest. When cells in this tube are spread out on an agar nutrient petri dish, each cell will be the starting cell for a new colony of cells and each colony will contain clones of the starting cell. cDNA libraries can be used simply to identify and determine the DNA sequence encoding a polypeptide you are studying. Or they can be made from different cell types or from cells of the same type but at different times or culture conditions. This allows comparison of which genes are turned on or off in the cells.

Recall that the mature mRNA in eukaryotic cells is spliced. This means that cDNAs from eukaryotic cells do not include introns. Introns, as well as sequences of enhancers and other regulatory elements in and surrounding a gene must be studied in genomic libraries (discussed below).

A. cDNA construction

mRNA is only a few percent of a eukaryotic cell; most is rRNA. But that small amount of mRNA can be separated from other cellular RNAs by virtue of their 3' *poly(A) tails*, simply running a total RNA extract over an *oligo-d(T) column* (illustrated below).

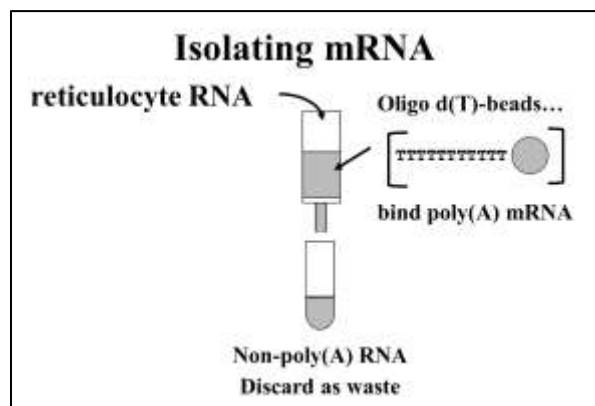

The strings of Ts (thymidines) can H-bond with the *poly(A) tails* of mRNAs, tethering the mRNAs on the column. All of the RNA without a 3' poly(A) tail then flows through the column as waste. A second buffer is passed over the column to destabilize the A-T interactions (H-bonds) allowing **elution** of the mRNA fraction (below).

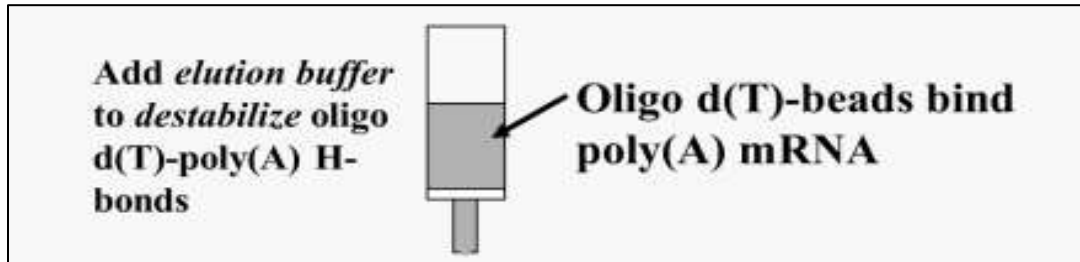

To make cDNAs from purified mRNAs, 'free' oligo d(T) is added to the eluted mRNA, where it now also forms H-bonds with the poly(A) tails of the mRNAs. The oligo d(T) serves as a primer for the synthesis of a cDNA copy of the polyadenylated mRNAs originally in the cells. **Reverse transcriptase** (nowadays 'store-bought' but originally isolated from chicken retrovirus-infected cells) is added next, along with DNA precursors (the 4 deoxynucleotides), and a cDNA strand complementary to the RNA is synthesized (below).

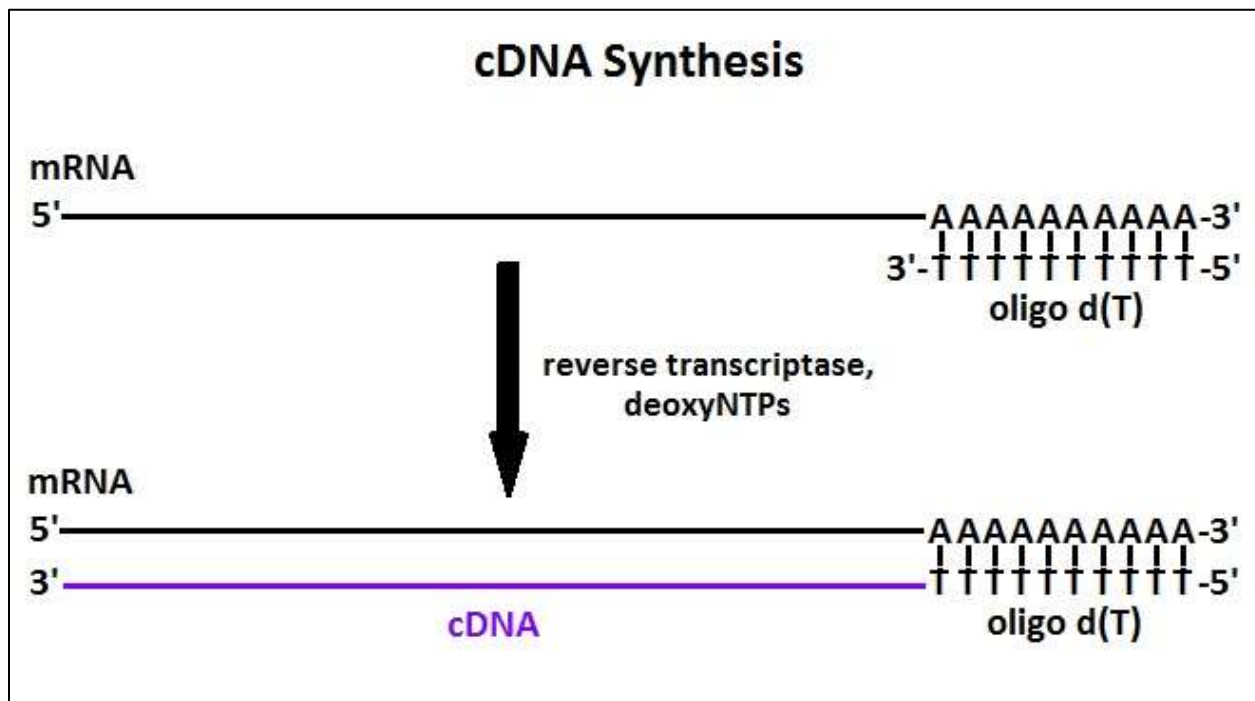

After heating to separate the mRNA from its cDNA, the cDNA is copied into its complement, again using reverse transcriptase. Reverse transcriptase has the same 5'-to-3' DNA polymerizing activity as DNA polymerases, and so can use DNA as well as RNA as a template. There is a short sequence at the 5'-end of most eukaryotic mRNAs that ends up at the 3'-end of the reverse-transcribed cDNA. This sequence is complementary to a short sequence *near* the 3' end of the message, allowing formation of a hairpin loop in which the 3' end of the cDNA serves as a ***built-in primer*** for second-strand synthesis (below)!

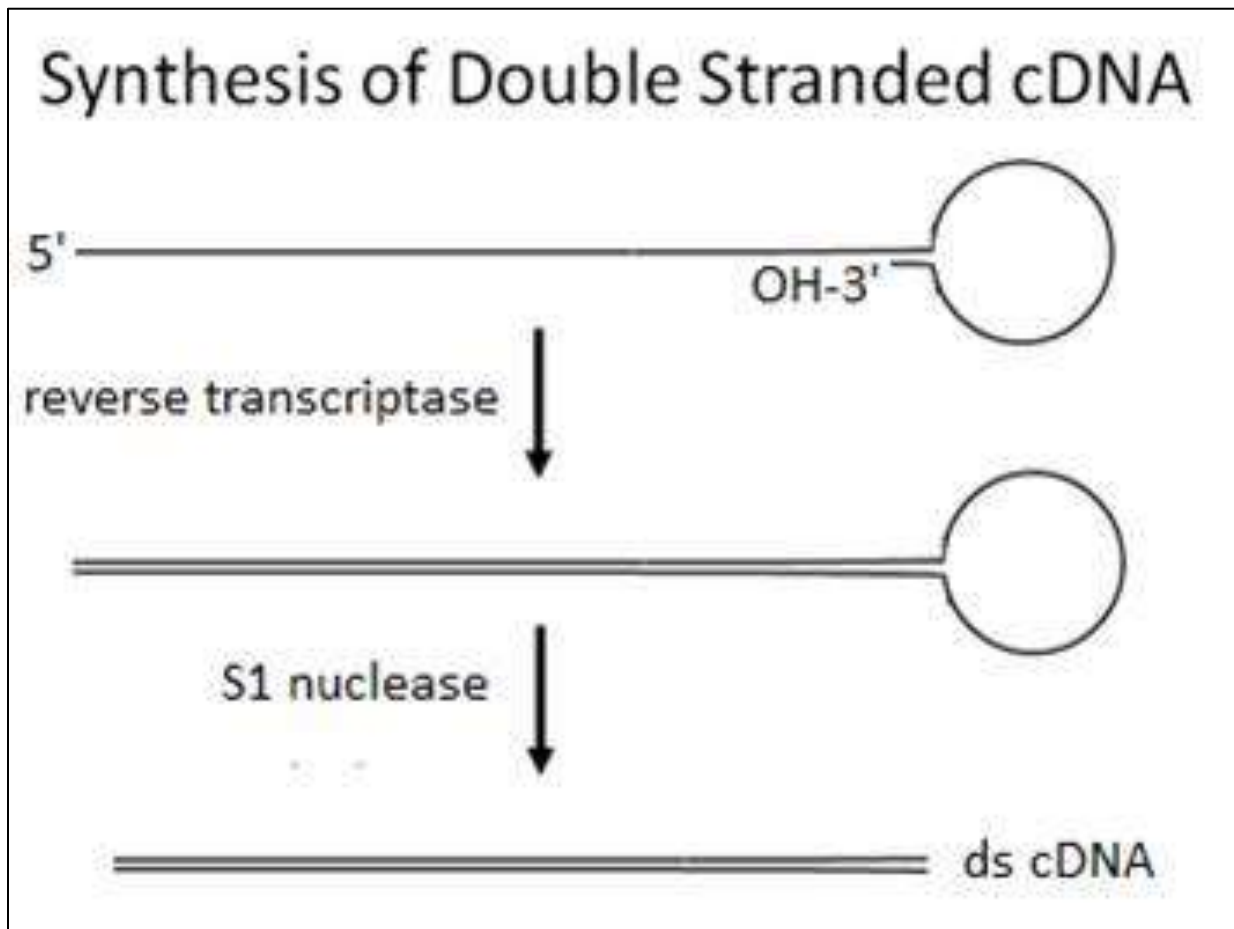

After the 2nd cDNA strand is made, S1 nuclease (a specifically single-stranded endonuclease) is added to open the loop of the double stranded cDNA structure and trimming any remaining single-stranded DNA and leaving behind a double-stranded cDNA.

B. Cloning cDNAs into plasmid vectors

To understand cDNA cloning and other aspects of making recombinant DNA, we need to talk about the recombinant DNA tool kit. The kit consists of several enzymes. One we have already seen is **reverse transcriptase**. As noted earlier, this enzyme was originally discovered in retrovirus-infected cells because it was required to “copy” (*reverse transcribe*) retroviral RNA in infected host cells into double-stranded DNA that can be replicated in the host cell (summarized below).

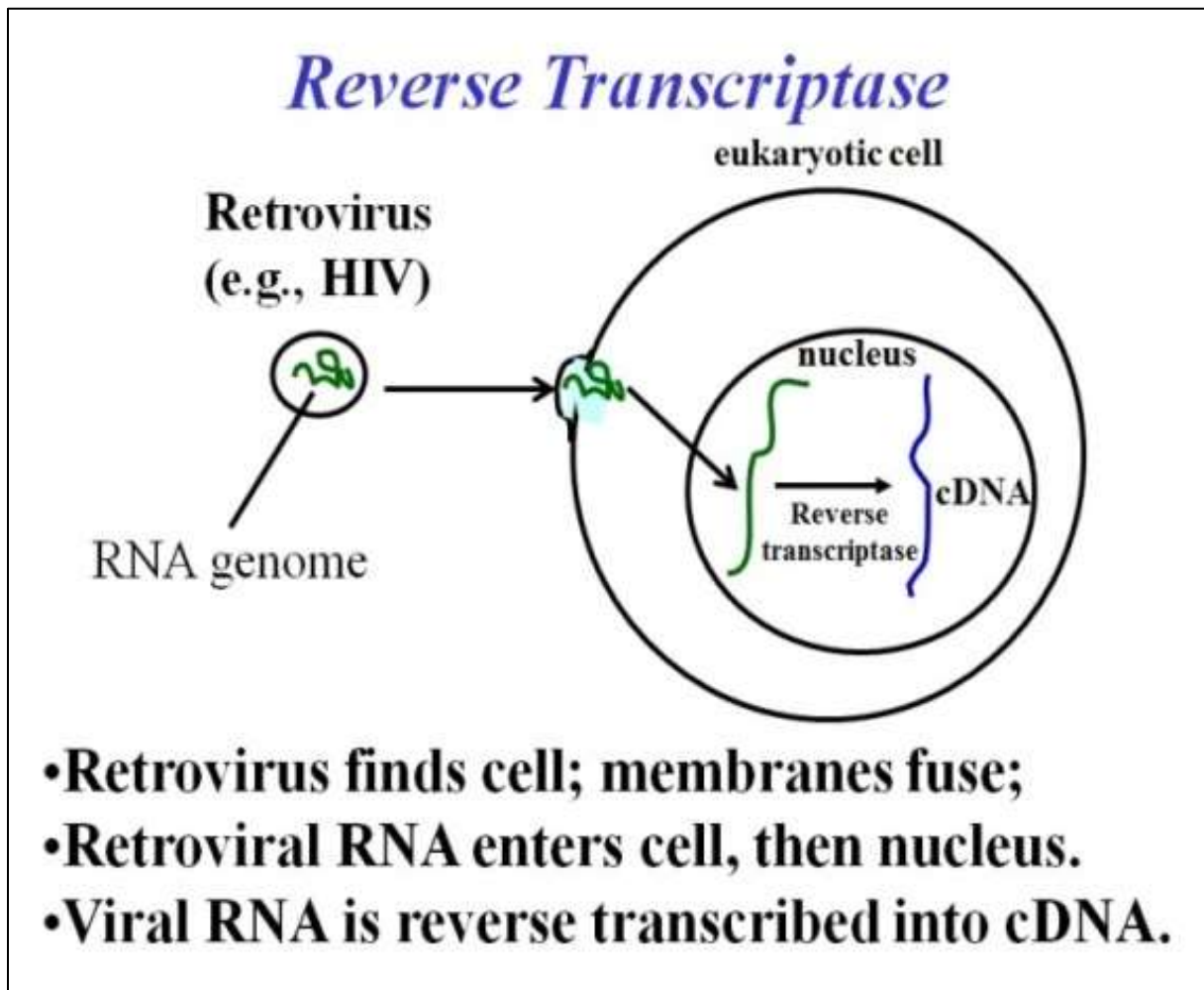

Other necessary enzymes in the ‘tool kit’ include the **restriction endonucleases**, or **restriction enzymes**. In normal bacterial cells, these enzymes locate specific restriction site sequences in DNA (most often **palindromic** DNA sequences).

Some **restriction enzymes** make the equivalent of a scissors cut through the two strands of the double helix, leaving *blunt ends*. Other restriction enzymes make a *staggered cut* on each strand at their restriction site, leaving behind *sticky*, or *complementary ends* (below).

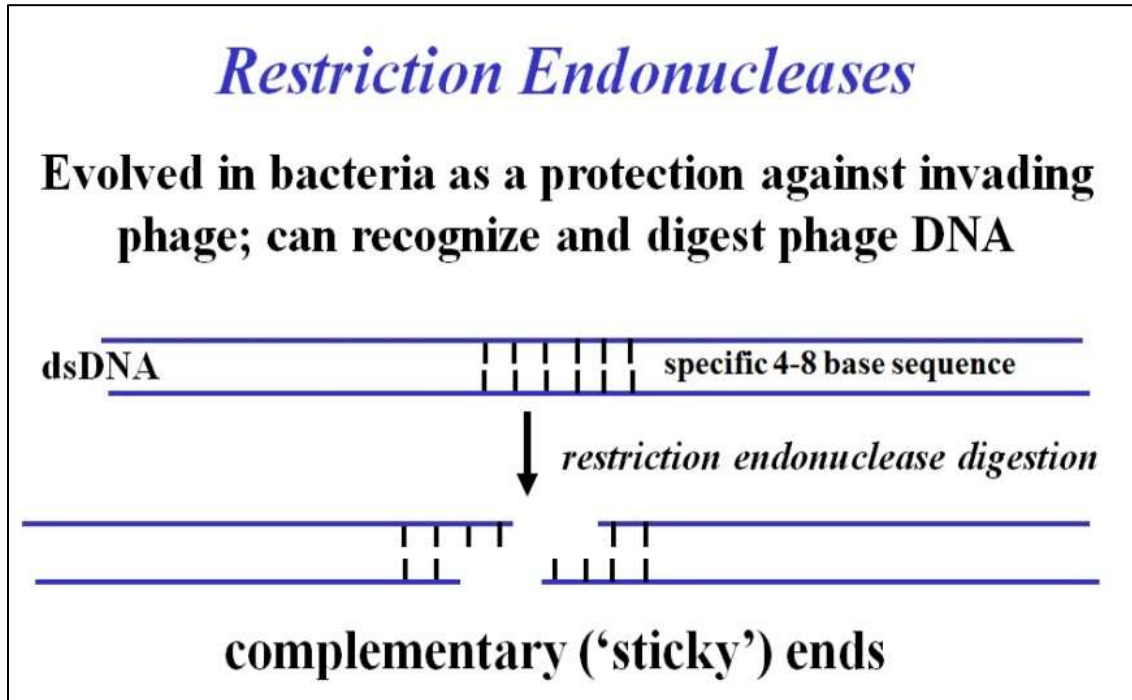

As you can imagine, two fragments of double-stranded DNA with the same sticky ends (even in DNA from different species) can come together and form H-bonds because of their complementary ends. That is, they can recombine! All that is left is to use **DNA ligase**, another 'tool kit' enzyme, to form the phosphodiester linkages between the two DNA molecules. Look for these 'tools' being used in the descriptions below.

1. ***Preparing recombinant plasmid vectors containing cDNA inserts***

Vectors are *carrier* DNAs that are recombined with a foreign DNA of interest. When the recombinant vector with its foreign **DNA insert** gets into a host cell, it can replicate many copies of itself along with the insert DNA to be studied. Plasmids are typical **vectors** for cloning cDNAs. To prepare for recombination, a plasmid vector is digested with **restriction enzyme** to open the DNA circle, leaving overhanging *sticky ends*. The double-stranded cDNAs to be inserted into the plasmid vectors are mixed with **linkers** and **DNA ligase** to put a linker DNA at both ends of the ds cDNA.

Linkers are short double-stranded DNA oligomers containing restriction sites that can be cut with the same restriction enzyme as the plasmid. Once the linkers have been attached to the ends of the plasmid DNAs, they can be digested with the appropriate restriction enzyme (usually the same one used to 'cut' the plasmid itself). This leaves both the ds cDNAs and the plasmid vectors with the same (complementary) sticky ends. These steps in the preparation of vector and ds cDNA for recombination are illustrated below.

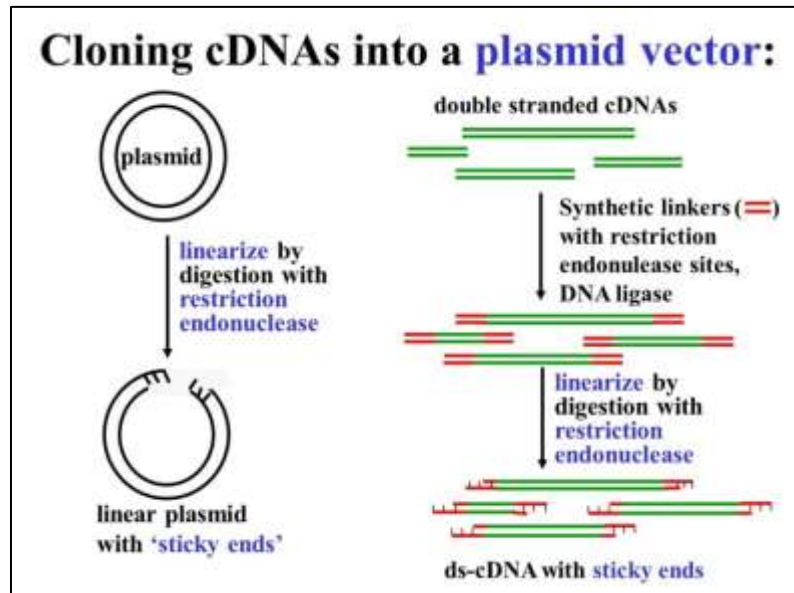

2. Recombining plasmids and cDNA inserts and transforming host cells

The next step is to mix the cut plasmids with the digested linker-cDNAs in just the right proportions so that the most of the cDNA (linker) ends will *anneal* (form H-bonds) with the most of the sticky plasmid ends. In early cloning experiments the goal was to generate plasmids with only one copy of a given cDNA insert, rather than lots of re-ligated plasmids with no inserts or lots of plasmids with multiple inserts. Using better-engineered vector and linker combinations, this issue became less important.

CHALLENGE: One improvement was genetically engineered vectors with multiple restriction enzyme sites and linkers for each of those sites. That way vectors could be cut with two different restriction enzymes and cDNAs would be ligated to linkers such that they had a different linker at each end. How might this fix have solved some of the recombination issues noted here?

In this example, adding DNA ligase forms the phosphodiester bonds, completing the recombinant circle of DNA (illustrated below).

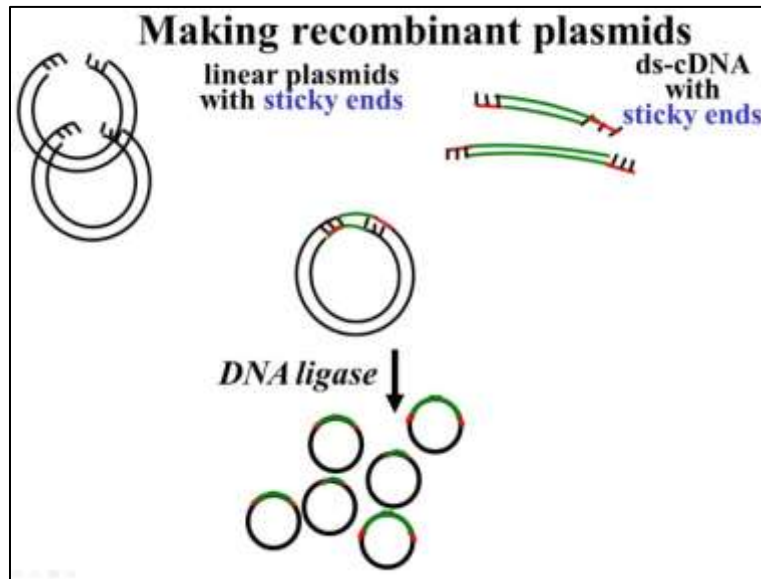

The recombinant DNA molecules are added to *E. coli* or other host cells that have been made permeable so that they can be easily **transformed** (below).

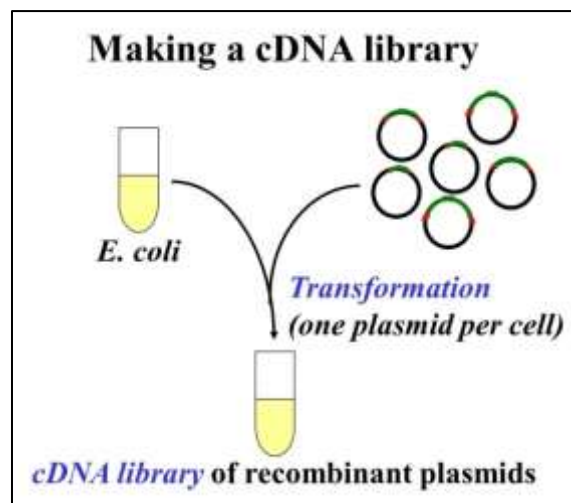

Recall that bacterial transformation as defined by Griffith is bacterial uptake of foreign DNA leading to a genetic change in the bacterium. The **transforming principle** in this bit of genetic engineering is the recombinant plasmid! The preparation of recombinant plasmids and their transformation into host cells is animated here:

<http://youtu.be/z-ydn718yM>.

Not all the plasmid molecules in the mix after all these treatments are recombinant, and some cells in the mix haven't even taken up a plasmid. So when the recombinant cells are plated out on agar, how does one tell which of the colonies that grow came from cells that took up a recombinant plasmid? Both the **host strain** of *E. coli* and plasmid vectors used these days were engineered to solve this problem. For example, host cells chosen to be transformed are sensitive to antibiotics. On the other hand, typical plasmid vectors were engineered to carry **antibiotic resistance genes**. Recombinant cells from a library created with plasmids containing an **ampicillin resistance gene** will grow on media containing ampicillin (a form of penicillin), while cells containing non-recombinant plasmids will not grow (illustrated below).

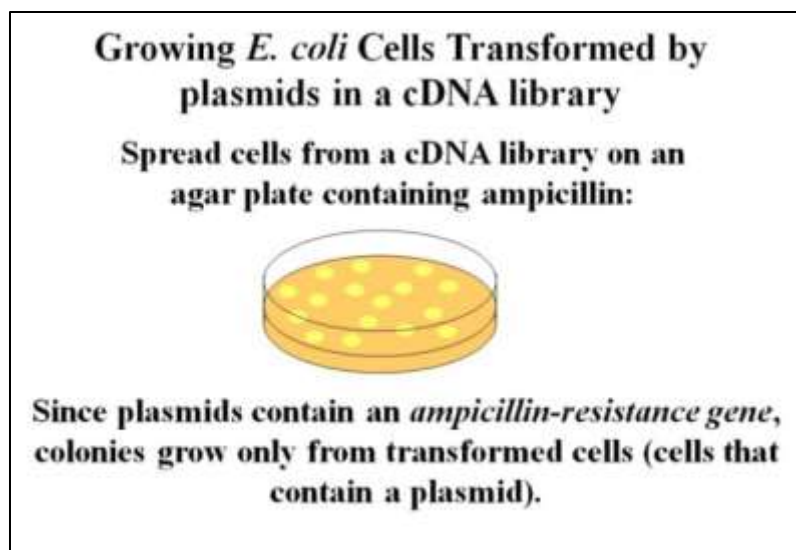

A typical cloning plasmid will also contain a second antibiotic resistance gene, for example **streptomycin**. The **streptomycin resistance gene** has been engineered to contain the restriction endonuclease sites for insertion of foreign e.g., cDNAs.

So, only transformed with recombinant plasmids will grow on ampicillin agar. But those cells may include some that were transformed by non-recombinant plasmids (ones that do not contain an insert). The latter cells (where could these have come from?) will grow on media containing streptomycin, while cells transformed with plasmids containing an insert will **NOT** grow in the presence of streptomycin. This is because the foreign DNA has been inserted smack in the middle of the streptomycin-resistance gene, and therefore cannot express the protein that would otherwise destroy streptomycin. We can tell apart *transformants* containing recombinant plasmids from those containing non-recombinant plasmids by the technique called **replica plating**.

After colonies grow on the ampicillin agar plate, lay a filter over the plate. The filter will pick up a few cells from each colony, in effect becoming a replica (mirror image) of the colonies on the plate. Place the replica filter on a new agar plate containing streptomycin. When new colonies form, they will only be non-recombinant clones. Finally, when you go back to the original ampicillin agar plate, you can easily identify the recombinant colonies (below).

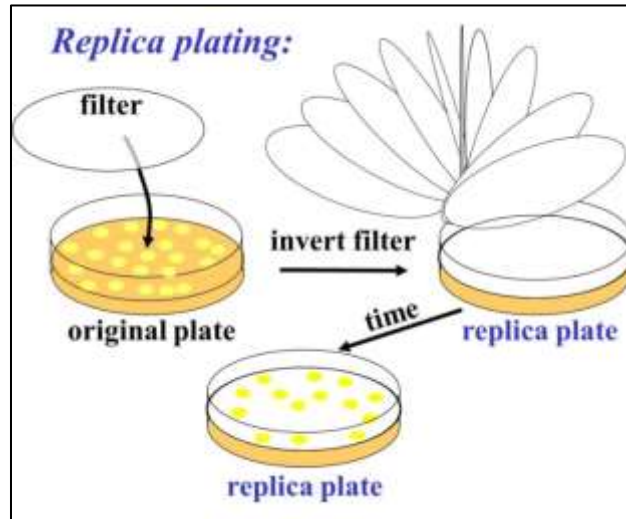

The replica plating procedure is animated at <http://youtu.be/nemMygDhMLc>.

3. Identifying colonies containing recombinant plasmids (recombinant clones)

The next step is to **screen** the recombinant colonies for those containing the specific cDNA that you are after. Typically this begins with ***in situ lysis*** to break open cells that have grown on a replica filter like the one above. ***In situ lysis*** disrupts cell walls and membranes so that the cell contents are released and the DNA is denatured (i.e., becomes single-stranded). The DNA then adheres to the filter *in place* (*in situ*, where the colonies were). The result is a filter with faint traces of the original colony (below)

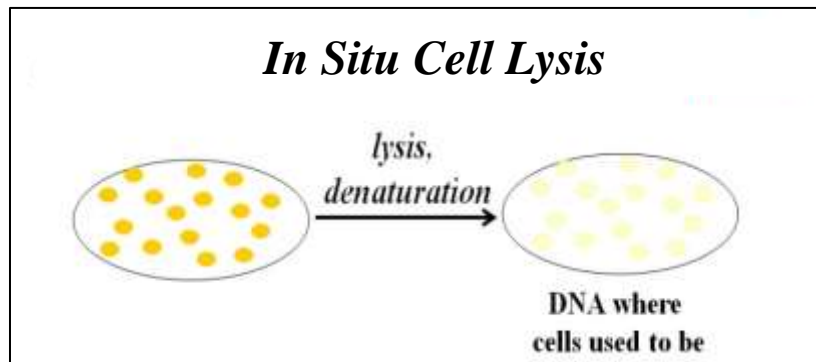

Next, a molecular **probe** is used to identify DNA containing the sequence of interest. The probe is often a **synthetic oligonucleotide** whose sequence was inferred from known amino acid sequences. These oligonucleotides are made radioactive and placed in a bag with the filter(s), where complementary sequences find each other. The result is that colonies containing cells with recombinant plasmids containing an insert of interest will bind the complementary probe (below).

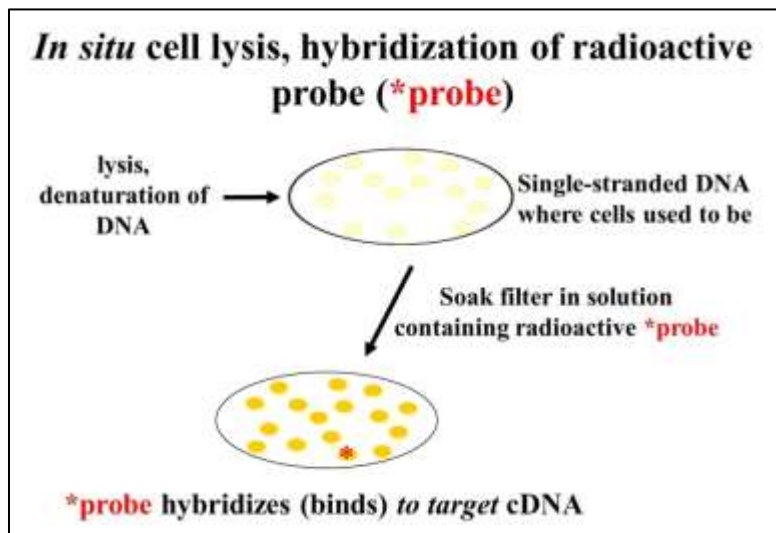

After rinsing the filters to remove un-bound radioactive oligomers, the filters are placed on X-ray film. After a period of exposure, the film is developed and will show a black spot corresponding to the position of any colonies containing a recombinant plasmid with your target sequence (below).

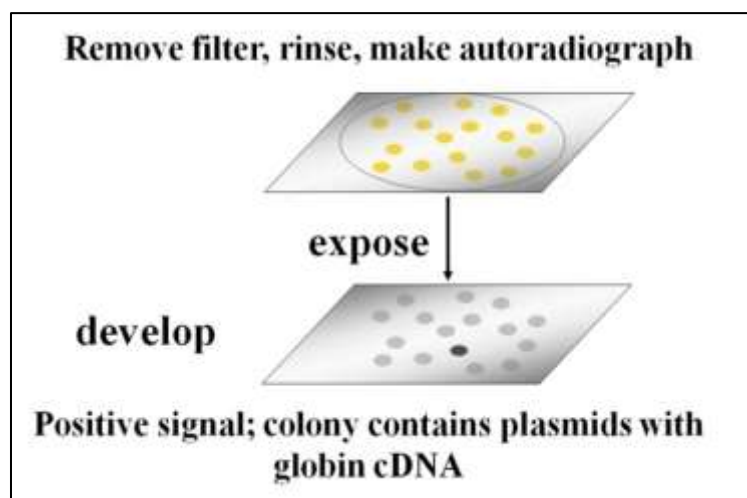

Once a positive clone is isolated, the recombinant colony is located on the original plate, the colony is grown up in a liquid culture and the plasmid DNA is isolated. Typically, the cloned cDNA is sequenced. The DNA sequence is then compared to the genetic code 'dictionary' to verify that the cDNA *insert* in the plasmid in fact encodes the protein of interest.

Cloned plasmid cDNAs can be tagged (made radioactive or fluorescent) to probe for the genes from which they originated, locate specific mRNAs in cells, identify them in RNA isolates from other cell types, and to quantitatively measure amounts of specific mRNAs. Isolated plasmid cDNAs can even be expressed in suitable cells to make the encoded protein. The synthetic insulin given to diabetics these days is no longer pig insulin, but is made from expressed human cDNAs. While the introduction of the *polymerase chain reaction (PCR, see below)* has superseded some uses of cDNAs, they still play a role in genome-level studies of e.g., the *transcriptome*.

III. [DNA sequencing](#) (Click to see Wikipedia's description)

A. A Brief History of DNA Sequencing

RNA sequencing came first, when Robert Holley sequenced a tRNA in 1965. tRNA sequencing was possible because the bases in tRNAs were chemically modified after transcription, and because tRNAs are short! Many tRNAs were eventually sequenced directly. An early method for sequencing DNA involving DNA fragmentation was developed by Walter Gilbert and colleagues. Frederick Sanger in England developed a DNA synthesis-based 'dideoxy' method of sequencing that quickly became the DNA sequencing standard. Sanger and Gilbert won a Nobel Prize in 1983 for their DNA sequencing efforts.

The first complete genome to be sequenced was that of a bacteriophage (bacterial virus) called $\phi X174$. At the same time as the advances in sequencing technology were occurring, so were some of the early developments in recombinant DNA technology. Together these led to the sequencing of DNA from more diverse sources than viruses. The first focus was on sequencing the genes and genomes of important model organisms, such as *E. coli*, *C. elegans* and yeast (*S. cerevisiae*). By 1995, Craig Venter and colleagues at the *Institute for Genomic Research* had completed the sequence of an entire bacterial genome (*Haemophilus influenzae*) and by 2001, Venter's private group along with Frances Collins and colleagues at the NIH had published a first draft of the sequence of the human genome. Venter had proved the efficacy of a whole-genome sequencing approach called *shotgun sequencing*, which was much faster than the gene-by-gene, fragment-by-fragment 'linear' sequencing strategy being used by other investigators (more later!).

B. Details of DiDeoxy Sequencing

Sanger's sequencing method is based on two key technologies:

1. The ability to *replicate* template different length fragments of DNA from a *template* DNA whose sequence you want to determine.
2. The ability to identify the last nucleotide on each newly made DNA fragment.

Since the Sanger dideoxynucleotide DNA sequencing method is still a common and economical methodology, let's consider the basics of the protocol.

Deoxynucleotides contain a ribose missing its 2' OH (hydroxyl) group. *Phosphodiester bonds* formed during replication link the α *phosphate* of a free **nucleotide triphosphate** to the 3' OH of a deoxynucleotide at the end of a growing DNA strand.

Dideoxynucleotide triphosphates are missing the 2' AND 3' OH groups on the sugar (shown as the hydrogen in red below).

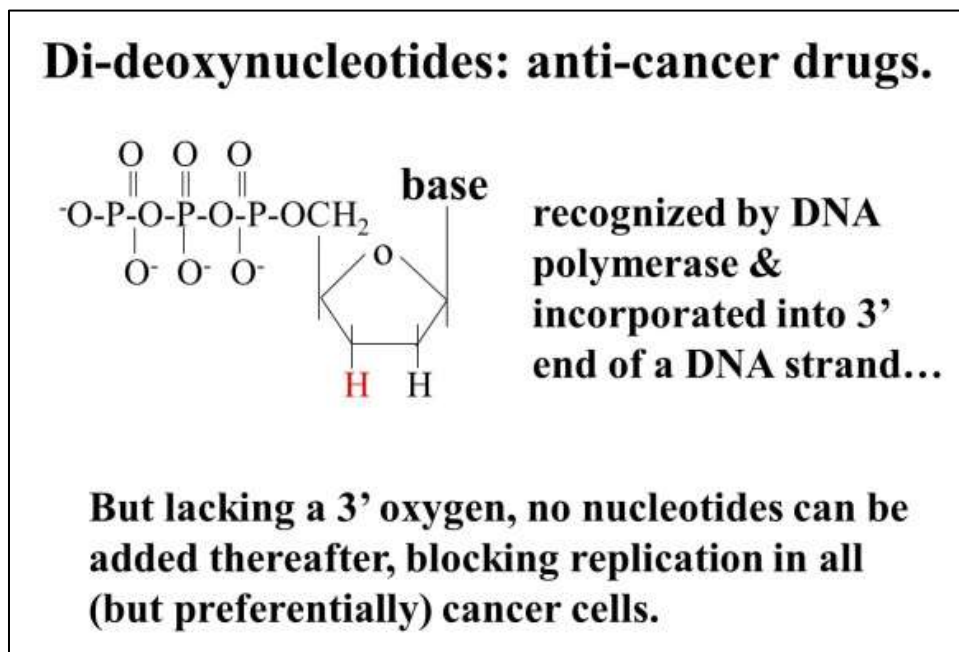

As a result, if this nucleotide is added to the end of a growing DNA strand, no further nucleotides can be added (the 3'-OH is necessary for the dehydration synthesis of the next phosphodiester bond). A look at the original form of manual sequencing reveals what is going on in the sequencing reaction.

Four reaction tubes are set up, each containing the template DNA to be sequenced, a primer and the 4 deoxynucleotide precursors necessary to replicate DNA (illustrated below).

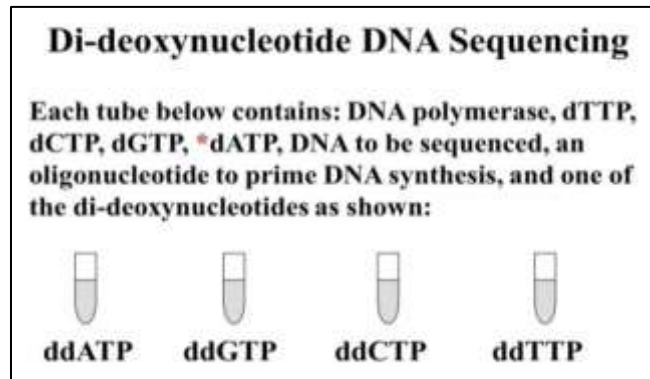

Each tube also contains a different *dideoxynucleotide* (ddATP, ddCTP, ddGTP or ddTTP). To start the sequencing reaction, DNA polymerase is added to each tube to start the DNA synthesis reaction. During DNA synthesis, different length fragments of new DNA are generated as the ddNTPs are incorporated at random opposite complementary bases in the template DNA being sequenced (below).

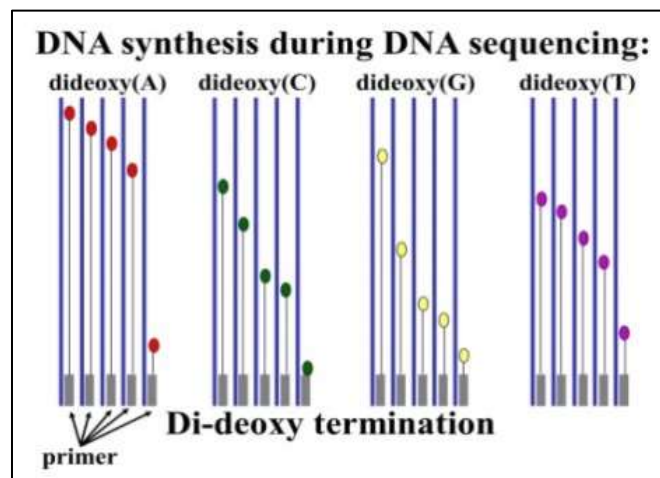

A short time after adding the DNA polymerase to begin the reactions, the mixture is heated to separate the DNA strands and fresh DNA polymerase is added to repeat the synthesis reactions. These sequencing reactions are repeated as many as 30 times in order to produce enough radioactive DNA fragments to be detected. With the advent of *Taq* polymerase from the thermophilic bacterium *Thermus aquaticus*, it became unnecessary to add fresh DNA polymerase after each replication cycle. The mixture could be heated and cooled at will without destroying the *Taq* DNA polymerase. Finally, the many cycles of chain-termination sequencing were automated by using *programmable thermocyclers*.

Since a small amount of a radioactive deoxynucleotide (usually ^{32}P -labeled ATP) was present in each reaction tube, the newly made DNA fragments were radioactive. The new DNA fragments from each tube are separated by electrophoreses. An autoradiograph of the gel then reveals the position of each terminated fragment, from which the DNA sequence can be read. A simulated gel is shown below.

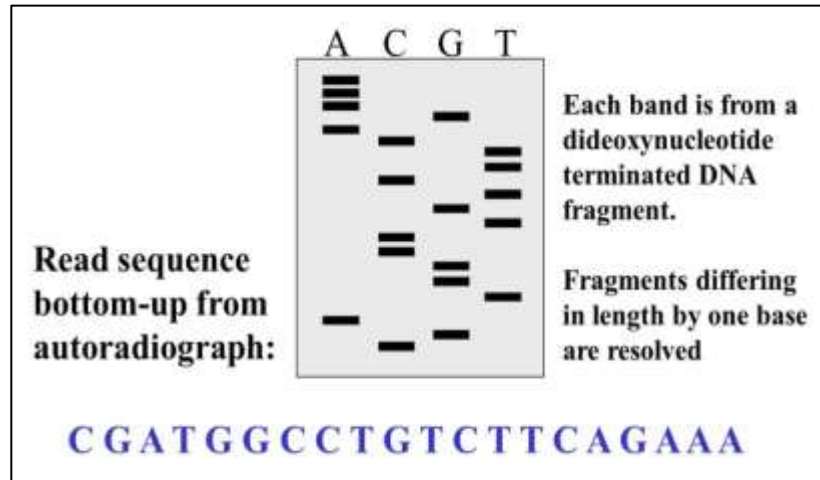

The first semi-automated DNA sequencing method was invented in Leroy Hood's California lab in 1986. This was still Sanger sequencing, but in this method, the 4 dideoxynucleotides in the sequencing reaction were tagged with a fluorescent dye. Instead of requiring radioactive phosphate-tagged nucleotides for DNA fragment detection, each dye-terminated DNA strand could be detected by its fluorescence. The color of fluorescence indicated which base terminated the DNA chain as it passed through a fluorescence detector, the smallest chains first, followed by the longer ones. A computer generated color-coded graph like the one below shows the order (and therefore length) of the fragments passing the detector and thus, the sequence of the strand.

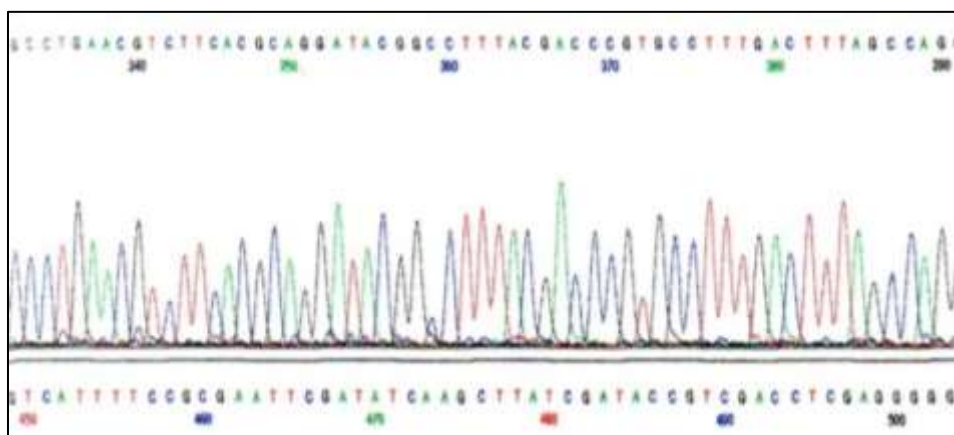

Hood's innovations were quickly commercialized making major sequencing projects possible, including whole genome sequencing. The rapidity of automated DNA sequencing led to the creation of large sequence storage databases in the U.S. and Europe. The U.S. database is maintained at the NCBI (National Center for Biological Information). Despite its location, the NCBI archives virtually all DNA sequences determined worldwide. With newer sequencing methods (some are described below) the databases and the tools to find, compare and otherwise analyze DNA sequences have grown by leaps and bounds.

C. Large scale sequencing

Large scale sequencing targets entire prokaryotic genomes and eukaryotic chromosomes (typically much larger than any bacterial genome) and requires strategies that either sequence long DNA fragments and/or sequencing DNA fragments more quickly. We already noted shotgun sequencing, used by Venter to sequence smaller and larger genomes (including our own... or more accurately, his own!). Shotgun sequencing is summarized below.

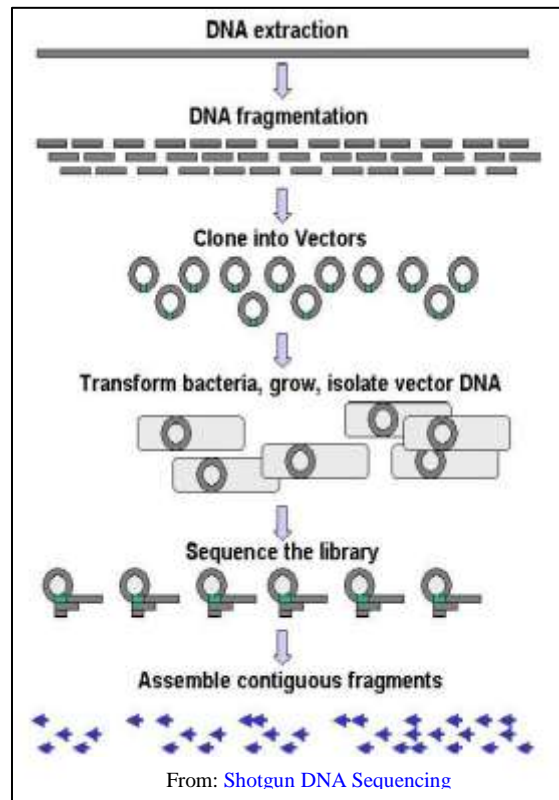

In shotgun sequencing, long cloned DNA fragments as long as or longer than 1000 base pairs are broken down at random into smaller, more easily sequenced fragments. The fragments are themselves cloned and sequenced, and non-redundant sequences are

assembled by aligning overlapping regions of sequence. Computer software these days are quite adept at rapidly aligning short overlapping sequences and displaying long contiguous DNA sequences.

Sequence gaps that remain after shotgun sequencing can be filled in by [primer walking](#), in which a known sequence near the gap is the basis of creating a sequencing primer to “walk” into the gap region on an intact DNA that has not been fragmented. Another technique involves **PCR** (the Polymerase Chain Reaction, described later), in which two oligonucleotides are synthesized based on sequence information on either side of a gap, and used to synthesize the missing fragment, which can then be sequenced to fill in the gap.

IV. [Genomic Libraries](#) (Click to see Wikipedia’s description)

A. Overview

A **genomic library** might be a tube full of **recombinant bacteriophage**. Each phage DNA molecule contains an insert, a fragment of cellular DNA from a foreign organism. The library is made so that it contains a representation of all of possible fragments of that genome. The viral genomes of bacteria were used clone genomic DNA fragments because:

- they could be engineered to remove a large amount of DNA that is not needed for infection and replication in bacterial host cells.
- the missing DNA could be replaced by fragments of foreign insert DNA as long as 18-20kbp (kilobase pairs), nearly 20 times as long as typical cDNA inserts.
- purified phage coat proteins could be mixed with the recombined phage DNA to make **infectious phage particles** that would infect host bacteria, replicate lots of new recombinant phage, and then lyse the cells to release the phage.

The need for vectors like bacteriophage that can accommodate long inserts becomes obvious from the following bit of math. A typical mammalian genome consists of more than *2 billion base pairs*. Inserts in plasmids are very short, rarely exceeding 1000 base pairs. Dividing *2,000,000,000 by 1000, you get 2 million*, a minimum number of phage clones that would need to be screened to find a sequence of interest. In fact, you would need many more than this number of clones to find a gene. Part of the solution to this “needle in a haystack” dilemma was to clone larger DNA inserts in suitable vectors.

From this brief description, you may recognize *the common strategy for genetically engineering a cloning vector*. Determine the minimum properties that your vector must have and remove non-essential DNA sequences. Consider the **Yeast Artificial Chromosome (YAC)**, hosted by (replicated in) yeast cells. YACs can accept humongous foreign DNA inserts! This is because to be a eukaryotic chromosome requires **one**

centromere and two telomeres... and little else! Recall that telomeres are needed in replication to keep the chromosome from shortening during replication of the DNA. The centromere is needed to *attach chromatids to spindle fibers* so that they can separate during *anaphase* in *mitosis* (and *meiosis*). So along with a centromere and two telomeres, just include restriction sites to enable recombination with inserts as long as 2000 Kbp. That's a YAC! Getting the YAC is the easy part. Keeping a 2000Kbp long DNA fragment intact long enough to get it into the YAC is the challenge.

Whatever the vector chosen and however they are obtained, sequences of genomic DNA can show us how a gene is regulated by revealing known and uncovering new regulatory DNA sequences. They can tell us what other genes are nearby, and where genes are on chromosomes. They can be used to find similar sequences in different species and comparative sequence analysis can tell us a great deal about gene evolution and the evolution of species. One early surprise from gene sequencing studies was that we share many common genes and DNA sequences with other species, from yeast to worms to flies... and of course mammals and other vertebrates. You probably know that our human genome and the chimpanzee genome are 99% similar. And we have already seen comparative sequence analysis that showed how proteins with different functions nevertheless share structural domains.

B. Preparing Recombinant Genomic Clones

1. *Preparing Genomic DNA of a Specific Length for Cloning*

Let's look at the approach to cloning a genomic library in phage – the principles would apply to any genomic cloning operation, but the numbers and details used here exemplify cloning in phage. To begin with, high molecular weight (i.e., long molecules of) the desired genomic DNA are isolated and purified and then digested with a restriction enzyme. Usually, the digest is partial, aiming to generate overlapping fragments of random length DNA. When the digest is electrophoresed on agarose gels, the DNA (stained with ethidium bromide, a fluorescent dye that binds to DNA) looks like a bright smear on the gel (e.g., below). All of the DNA could be recombined with suitably digested vector DNA. But to further reduce the number of clones to be screened for a sequence of interest, early cloners would generate a **Southern blot** to determine the size of genomic DNA fragments most likely to contain a desired gene. Briefly here is the protocol for making a *Southern blot* (named after Edward Southern, the inventor of the technique) and cloning inserts of a specific size:

- a) Digest genomic DNA with one or more restriction endonucleases.
- b) Run the digest products on an agarose gel to separate the fragments by size (length). The DNA will appear as a smear when stained with a fluorescent dye.
- c) Place a filter on the gel. Over several hours, the DNA will be blotted to the filter.

- d) Remove the filter and place it in a bag in a solution that can denature the DNA.
- e) Add a radioactive probe (e.g., cDNA) containing the gene or sequence of interest. The probe will hybridize (bind) to a complementary genomic sequence on the filter.
- f) Prepare an autoradiograph of the filter and see a 'band' representing the size of genomic fragments of DNA that include the sequence of interest.
- g) Run another gel of the digested genomic DNA and using the information from the Southern blot, cut out the piece of gel containing the fragments that 'lit up' in the autoradiograph.
- h) Remove the DNA from the gel piece and use it as the source of inserts for genomic cloning.

These steps are illustrated below.

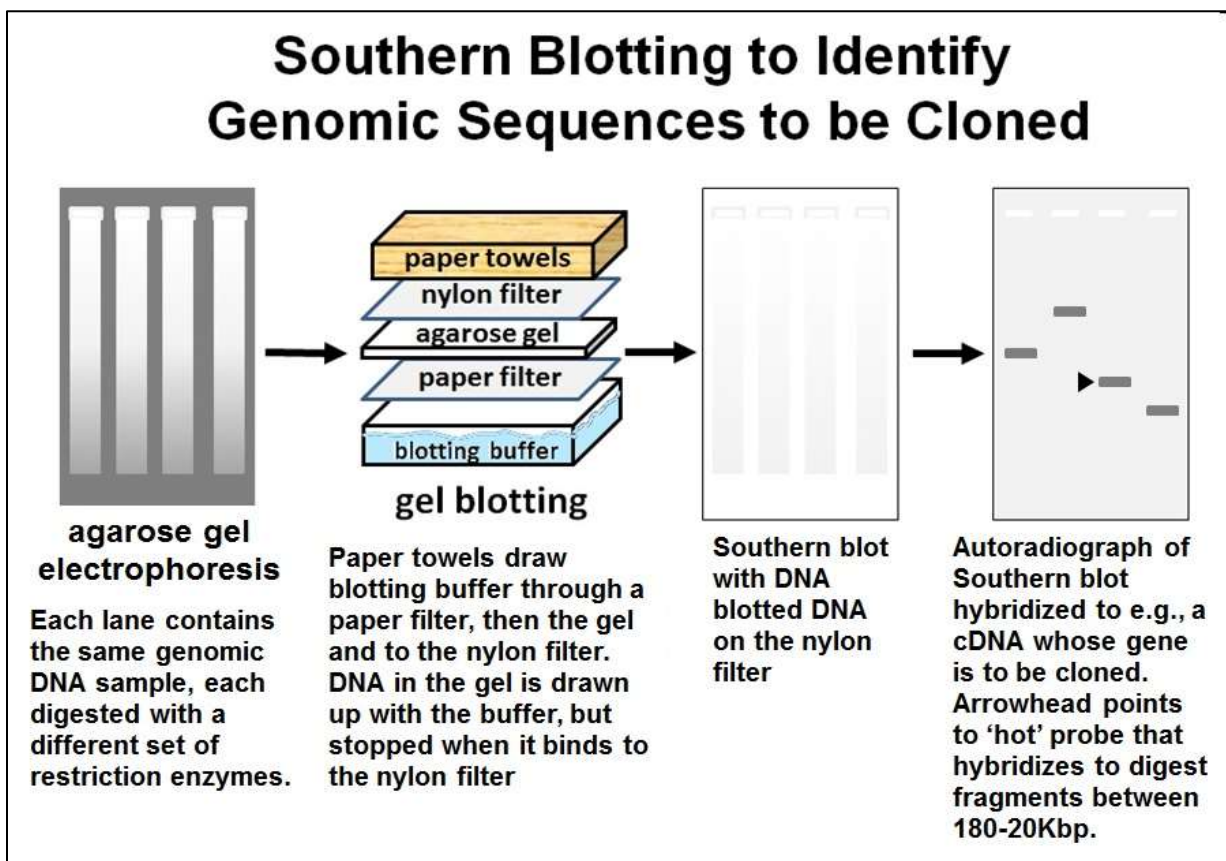

CHALLENGE: Why do the genomic DNAs on the gel (above at the left) appear as a smear instead of bands of discrete size/length?

2. Recombining Size-Restricted Genomic DNA with Phage DNA

The Southern blot allows identification of a set of restriction enzymes that generates 18-20 Kbp genomic DNA fragments that hybridize to the probe. More genomic DNA is digested with the same set of restriction enzymes and then separated on an agarose gel. A chunk of agarose containing only those fragments ranging between 18kbp and 20kbp is excised from the gel. The DNA in this gel chunk is isolated and mixed with compatibly digested phage DNA at concentrations that favor the formation of H-bonds between the ends of the phage DNA and the genomic fragments. The addition of DNA ligase covalently links the recombined DNA molecules. These steps are abbreviated in the illustration below.

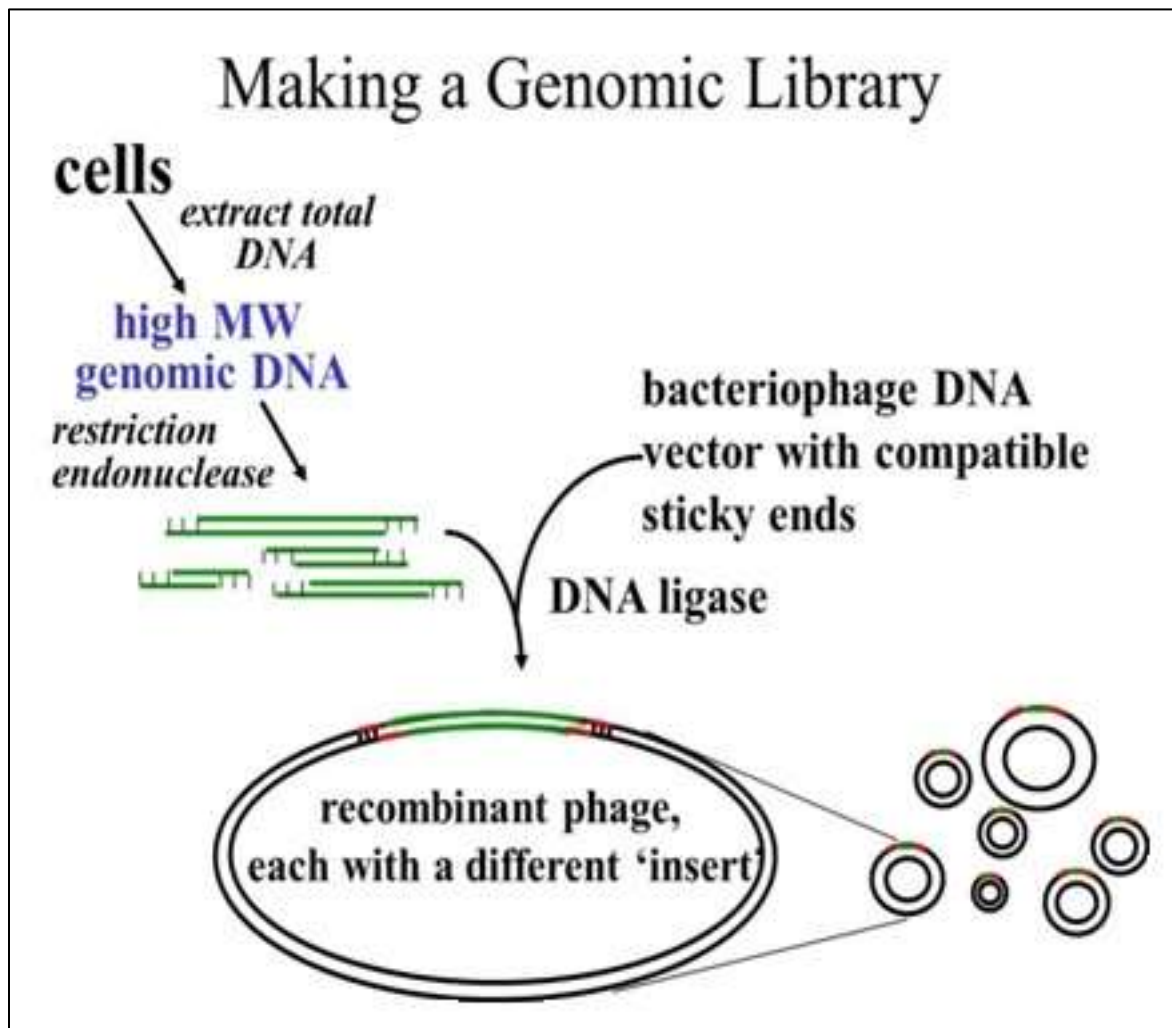

3. **Creating Infectious Viral Particles with Recombinant phage DNA**

As noted, the recombined phage DNA can be introduced into a bacterial host by adding viral coat proteins to make infectious phage (below).

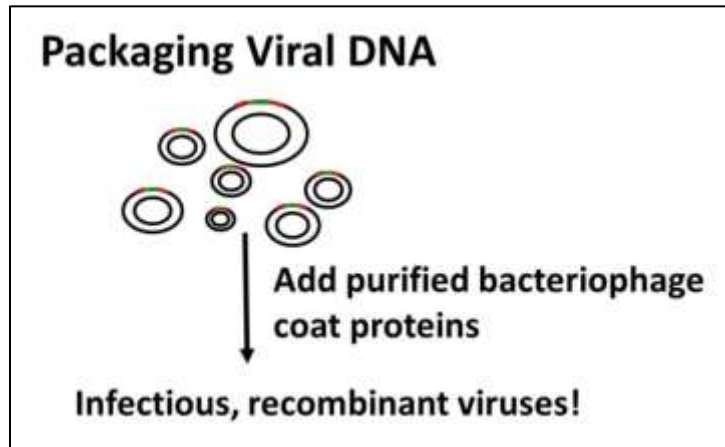

The phage are added to a tube-full of host bacteria. Infection follows and the recombinant DNA enters the cells where it replicates and directs the production of new phage that eventually lyse the host cell (illustrated below).

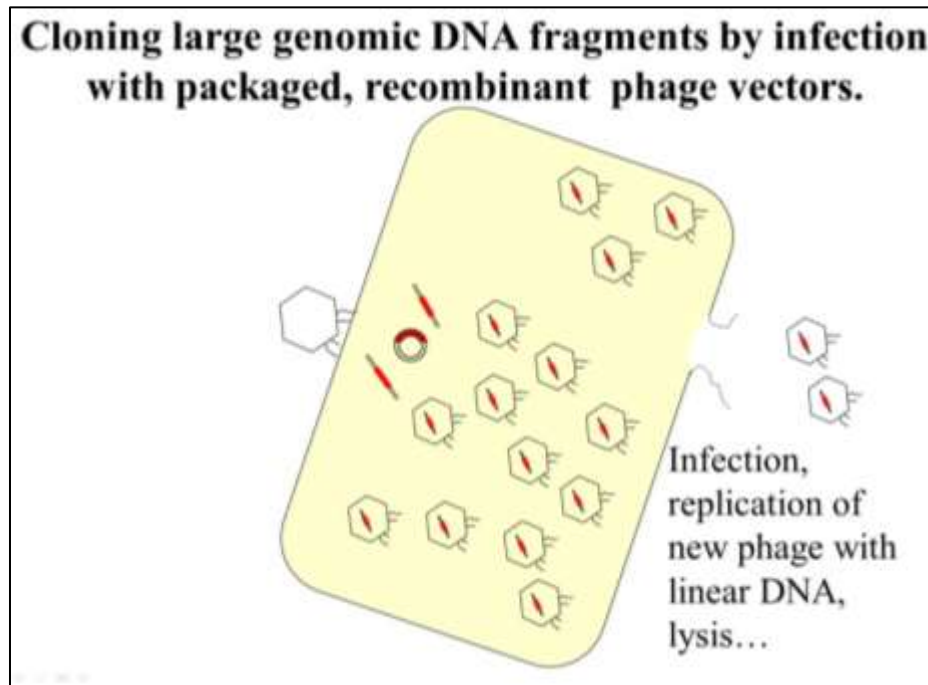

The recombined vector can also be introduced directly into the host cells by **transduction** (which is to phage DNA what transformation is to plasmid DNA). Whether by infection or transduction, the recombinant phage DNA ends up in host cells which produce new phage that lyse the host cell. The released phages go on to infect more host cells until all cells have lysed. What remains is a tube full of **lysate** containing cell debris and recombinant phage particles.

4. A Note About Some Other Vectors

As we see comparing plasmids to phage DNA vectors, different vectors can accommodate different size inserts. For larger genomes, the need is to choose a vector able to house larger inserts so that you end up screening the minimum number of clones. Given a large enough eukaryotic genome, it may be necessary to screen more than a hundred thousand clones in a phage –based genomic library. Apart from size-selection of genomic fragments before inserting them into a vector, selecting the appropriate vector is just as important. The table below lists commonly used vectors and the sizes of inserts they will accept.

Vector type	Insert size (thousands of bases)
Plasmids	up to 15
Phage lambda (λ)	up to 25
Cosmids	up to 45
Bacteriophage P1	70 to 100
P1 artificial chromosomes (PACs)	130 to 150
Bacterial artificial chromosomes (BACs)	120 to 300
Yeast artificial chromosomes (YACs)	250 to 2000

Click on the vectors to learn more about them. We'll continue this example by looking at how recombinant phage in a genomic library are screened for a genomic sequence of interest.

C. Screening a Genomic Library

1. *Titering a Phage Lysate: Plating and Counting Recombinant Phage Clones in a Genomic Library*

A phage lysate is **titered** on a **bacterial lawn** to determine how many virus particles are present. A bacterial lawn is made by plating so many bacteria on the agar plate that they simply grow together rather than as separate colonies. In a typical **titration** a lysate might be diluted 10-fold with a suitable medium and this dilution is further diluted 10-fold... and so on. Such **serial 10X dilutions** are then spread over the bacterial lawn of e.g., *E. coli* cells. If 10 μ l of a dilution containing say, 500 hundred of infectious virus particles are spread on the bacterial lawn, they will infect 500 *E. coli* cells on the lawn. After a day or so, there will be small clearings in the lawn called **plaques**. These are clear spaces on the bacterial lawn created by the lysis of first one infected cell, and then progressively more and more cells neighboring the original infected cell. Each plaque is thus a clone of a single virus, and each virus particle in a plaque contains a copy of the same recombinant phage DNA molecule (below).

**Screening the genomic library for a
globin gene clone**

**Spread library on bacterial lawn on agar plate;
phage lyse the bacterial cells leaving cleared
areas (plaques), each formed from a single
phage:**

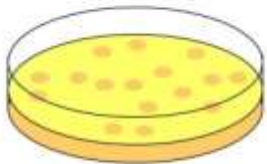

**...represents most or all of the sequences in
cloned genomic fragments.**

In this example, if you could count 500 plaques on an agar plate, then there must have been 500 virus particles in the 10 μ l seeded onto the lawn. And if this plate was the 4th dilution in a 10-fold serial dilution protocol, there must have been 4 X 500 phage particles in 10 μ l of the original undiluted lysate.

2. Probing the Genomic Library

In order to represent a *complete genomic library*, it is likely that many plates of such a dilution (~500 plaques per plate) will have to be created and then screened for a plaque containing a gene of interest. If only size-selected fragments were inserted into the phage vectors, the plaques will represent a *partial genomic library*, requiring screening fewer clones to find the sequence of interest. For either kind of library, the next step is to make replica filters of the plaques. Replica plating of plaques is similar to making a replica filter bacterial colonies. But in this case, there will be DNA in the plaque replicas that never got packaged into viral particles. The filters can be treated to denature this DNA and can then be probed directly with a known sequence

In the early days of cloning, this probe was usually an already isolated and sequenced cDNA clone, either from the same species as the genomic library, or from a cDNA library of a related species. After soaking the filters in a tagged (radioactive) probe, X-Ray film is placed over the filter, exposed and developed. Black spots will form where the film lay over a plaque containing genomic DNA complementary to (and therefore *hybridized* to) the radioactive probe, as illustrated below.

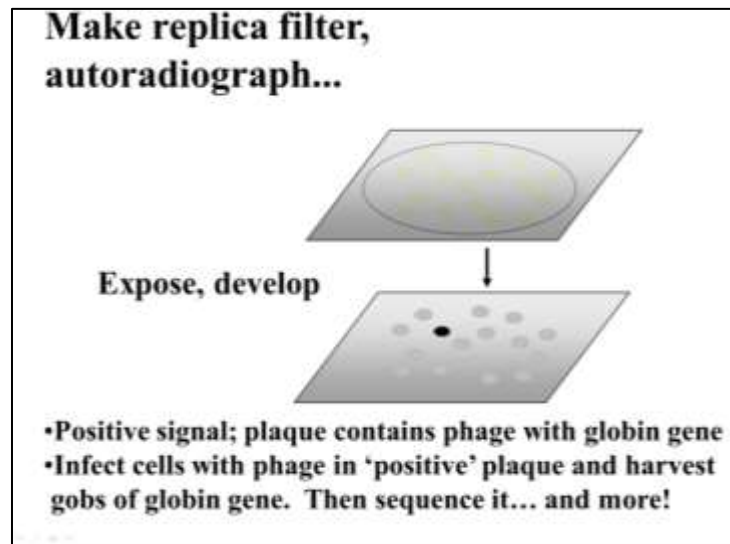

3. Isolating a Gene for Further Study

Genomic clones are typically much larger (longer) than any gene of interest, and always longer than any cDNA from a cDNA library. They are also embedded in a genome that is thousands of times as long as the gene itself. As noted earlier,

cloning large chunks of a genome in commodious vectors reduces the number of clones to be screened for a gene. If the genome can be screened among a reasonable number of cloned phage (under 100,000 plaques for instance), the one plaque containing a positive signal would be further studied. To find out where a gene is in a large genomic clone (20+kbp long), the traditional strategy is to purify the cloned DNA, digest it with restriction endonucleases and separate the digest particles by *agarose gel electrophoresis*. Using *Southern Blotting*, the separated DNA fragments are denatured and blotted to a nylon filter. The filter is then probed with the same tagged probe used to find the positive clone (plaque). The smallest DNA fragment containing the gene of interest will usually be the object of further study and analysis. Such fragments can themselves be *subcloned* (in suitable vectors) and grown to provide enough DNA to further study the gene.

V. [The Polymerase Chain Reaction \(PCR\)](#) (Click to see Wikipedia's description)

The polymerase chain reaction (PCR) can *amplify* a region of DNA from any source, even from a single cell's worth of DNA or from fragments of DNA obtained from a fossil. This amplification, which can take just a few hours, can generate millions of copies of the desired *target* DNA sequence, in effect purifying the DNA from surrounding sequences in a single reaction!. Kary B. Mullis was awarded a Nobel Prize in 1993 for his development of PCR, which is now the basis of innumerable molecular strategies for producing DNAs for research in gene structure, function and evolution as well as in criminal forensics, medical diagnostics and other commercial uses. PCR is described in detail below.

A. PCR – the Basic Process

PCR relies on using some bits of known DNA sequence, such as that of a cDNA, to design short oligonucleotide sequences (*oligomers*) that are then synthesized in the laboratory. The oligomers are chosen to be complementary to sequences near the opposite ends of the known DNA sequence such that the **oppose** (face) each other. That just means that the 3' end of one oligomer faces the 3' end of the opposing oligomer. This way the two oligomers can serve as *primers* for the elongation replication of both strands of a double stranded target DNA sequence. The primers are added to the target DNA source from which a gene is to be amplified by PCR.

The mixture is then heated to denature the target DNA. After cooling the mixture to allow the primers to H-bond with their complementary target DNA strands, the four deoxynucleotide precursors to DNA (dATP, dCTP, dTTP and dGTP) are added along with a small amount of a DNA polymerase. This allows elongation of new DNA strands from the oligonucleotide primers on the template DNAs.

To make lots of the PCR product, this reaction cycle must be repeated many times. So after allowing elongation, the mixture is heated to denature (separate) all the DNA strands. When the mixture is again cooled, the oligomers again find complementary sequences with which to H-bond.

Because PCR originally relied on an *E. coli* DNA polymerase which is inactivated by heating, fresh enzyme had to be added to the PCR mixture for each elongation cycle. Shortly after these early PCR efforts, researchers switched to using **Taq polymerase**, a heat-stable DNA polymerase from *Thermus aquaticus*. The enzymes of *T. aquaticus* do not unfold (denature) or become inactive at the very high temperatures at which these organisms live. Because heating does not destroy the Taq polymerase, PCR could be automated with programmable *thermocyclers* that raised and lowered temperature required by the PCR reactions. There was no longer a need to replenish Taq polymerase once the reaction cycles were begun. Thermocycling in a typical PCR amplification is illustrated below for the first two PCR cycles, which produces the first strands of DNA that will actually be amplified *exponentially*.

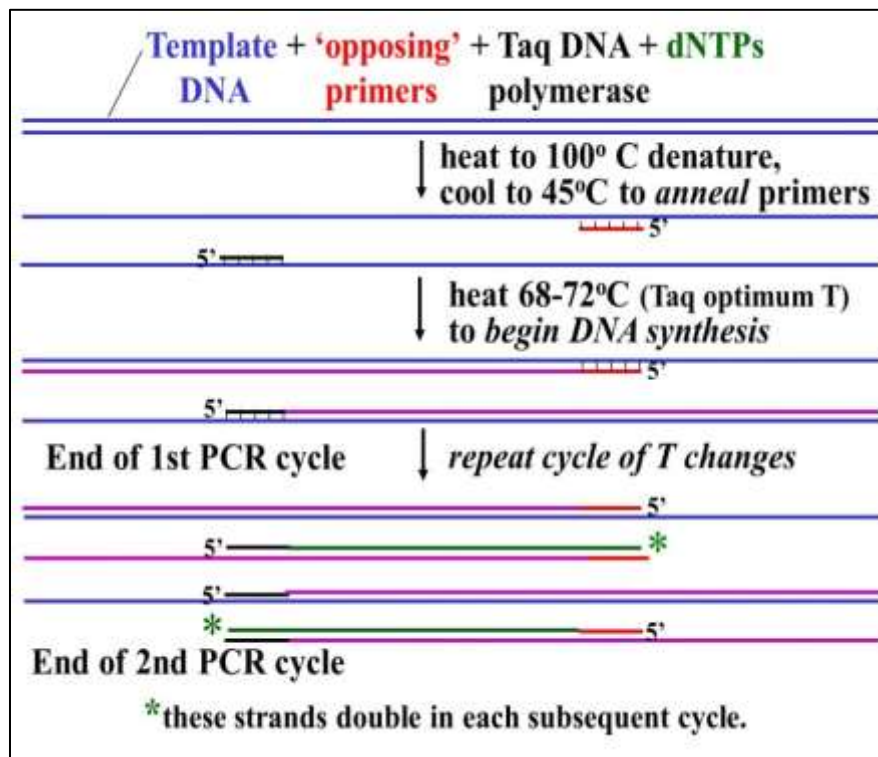

From the illustration, you can see that the second cycle of PCR has generated the two DNA strands will serve as templates for the doubling and re-doubling of the desired product after each subsequent cycle.

A typical PCR reaction might involve 30 PCR cycles, resulting in a nearly exponential amplification of the desired sequence.

CHALLENGE: Starting with a pair of complementary target DNA molecules (after the 3rd PCR cycle), how many double stranded PCR products should you theoretically have at the end of all of the 30 PCR cycles?

The amplified products of PCR amplification products are in such abundance that they can easily be seen under fluorescent illumination on an *ethidium bromide*-stained agarose gel (below).

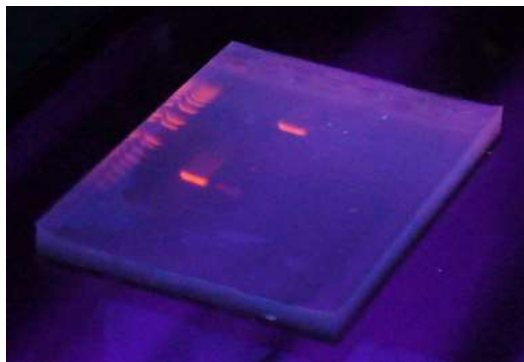

Adapted from:

<http://upload.wikimedia.org/wikipedia/commons/e/e6/AgarosegelUV.jpg>

In this gel, the first lane contains a *DNA ladder*, which is a mixture of DNAs of known lengths that can be used to size the PCR fragments in the adjacent lanes. The gel lane next to the ladder is empty, while the two bright bands in the 3rd and 4th lanes are PCR products generated with two different oligomer primer pairs. PCR-amplified DNAs can be sequenced and then used in many subsequent studies.

B. The many Uses of PCR

PCR-amplified products can be labeled with radioactive or fluorescent tags to serve as hybridization probes for clone isolation from cDNA or genomic libraries, or on Southern blots (or northern blots, a more fanciful name for RNAs that are separated by size on gels and blotted to filters). We noted above that PCR has wide applications to research, medicine and other practical applications. A major advance was *Quantitative PCR*, applied to studies of differential gene expression and gene regulation. In Quantitative PCR, initial cDNAs are amplified to detect not only the presence, but the relative amounts of specific transcripts being made in cells.

Another application of PCR is in the forensics, to identify a person or organism by comparing its DNA to some standard, or control DNA. An example of a gel showing these *DNA fingerprints* is shown below.

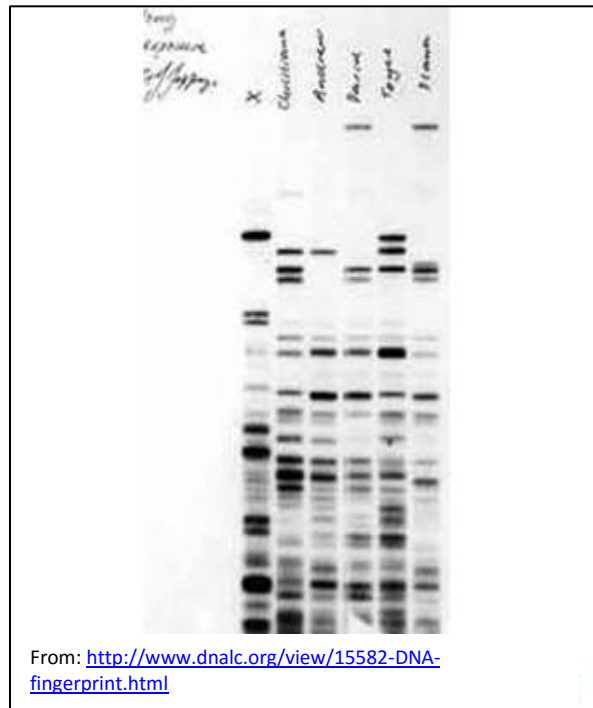

Using this technology, it is now possible to detect genetic relationships between near and distant relatives (and to exclude such relationships), determine paternity, demonstrate evolutionary relationships between organisms, and on many occasions, solve recent and even ‘cold-case’ crimes. Click [Sir Alec Jeffries](#) to learn about the origins of DNA fingerprinting in real life ...and on all those TV CSI programs!

A video on DNA fingerprinting is at the following link: [Alu and DNA fingerprinting](#). *Alu* is a highly repeated ~300bp DNA sequence found throughout the human genome. *Alu* sequences are *short interspersed elements*, or **SINES**, a category of mobile, or transposable elements (transposons). DNA fingerprinting is possible in part because each of us has a unique number and distribution of *Alu* SINEs in our genome. You can read more about *Alu* sequences and human diversity at [Alu Sequences and Human Diversity](#).

Intriguing examples of the use of PCR for identification include establishing the identities of Egyptian mummies, the Russian Tsar deposed during the Russian revolution, and the recently unearthed body of King Richard the 3rd of England. Variant PCR protocols and applications are manifold and often quite inventive! A list is presented at this link: [Variations on Basic PCR](#).

VI. Genomic Approaches: [The DNA Microarray](#) (Click to see Wikipedia's description)

Where cell levels of a protein are known to change in response to a chemical effector, molecular studies traditionally focused on control of transcription of its gene. These studies often revealed that the control of gene expression was at the level of transcription, turning a gene on or off through interactions of transcription factors with DNA. However, control of a protein level sometimes turns out to be post-transcriptional, at the level of the rate of mRNA degradation or of translation. Such studies were seminal to our understanding of how a gene is controlled and how the right correct protein is made at the right time.

We might have suspected, but now we know that control of gene expression and cellular responses can be more complex than increasing the transcription of a single gene or translation of a single protein. Whole genome sequences and new techniques make possible the study of the expression of virtually all genes in a cell at the same time, a field of investigation called **genomics**. Genomic studies reveal a web, or network of responses that must be understood to more fully explain developmental and physiological changes in an organism. When you can 'see' all of the genes that are active in a cell or tissue, you are looking at its **transcriptome**, an area of study sometimes called **transcriptomics**. The study of which proteins are being synthesized in a cell or a tissue, how they are modified (processed) before use and how much of each is being synthesized is called **proteomics**. The technologies applied to proteomic studies include protein microarrays, immunochemical techniques and other uniquely suited to proteins analysis (for more information, see <http://en.wikipedia.org/wiki/Proteomics>). Protein Microarrays are increasingly being used to identify protein-protein interactions, as well as the different states of proteins under different cellular conditions. Read even more about these exciting developments and their impact on basic and clinical research at <http://www.ncbi.nlm.nih.gov/pubmed/22989767>. Finally think about this: creating a proteomic library analogous to a genomic library would seem a daunting prospect. But efforts are underway! Check out [Strategies for Approaching the Proteome](#) for more information. Also check out the link at [A stab at mapping the Human Proteome](#) for original research leading to a sampling of a tissue-specific human proteome.

Microarray technology involves 'spotting' cloned DNA (oligonucleotides, PCR products, or DNA from a genomic or cDNA library) on a glass slide, or chip. In the language of microarray analysis, the slides are the **probes**. Spotting a chip is a robotic process, animated in this link: <http://youtu.be/p2zxwQl8n9s>. Because the DNA spots are microscopic, oligonucleotides, PCR products, or a cell-specific transcriptome (cDNA library) can usually be accommodated on a single chip. A small genome microarray might also fit on a single chip, while larger genomes might need several slides.

A primary use of DNA microarrays is **transcriptional profiling**. A genomic microarray can probe a mixture of fluorescently tagged target cDNAs made from mRNAs, in order to identify which genes are expressed in the cells, or its transcriptome. A cDNA microarray can probe quantitative differences in gene expression in cells or tissues during normal differentiation or in response to chemical signals. They are also valuable for genotyping, (i.e. characterizing the genes in an organism).

Microarrays are so sensitive that they can even distinguish between two genes or regions of DNA that differ by a single nucleotide. Such differences are called SNPs, or **single nucleotide polymorphisms** (click the link to learn more). After probing with one or more fluorescence-tagged nucleic acids, the microarray is viewed in a fluorescent microscope (below).

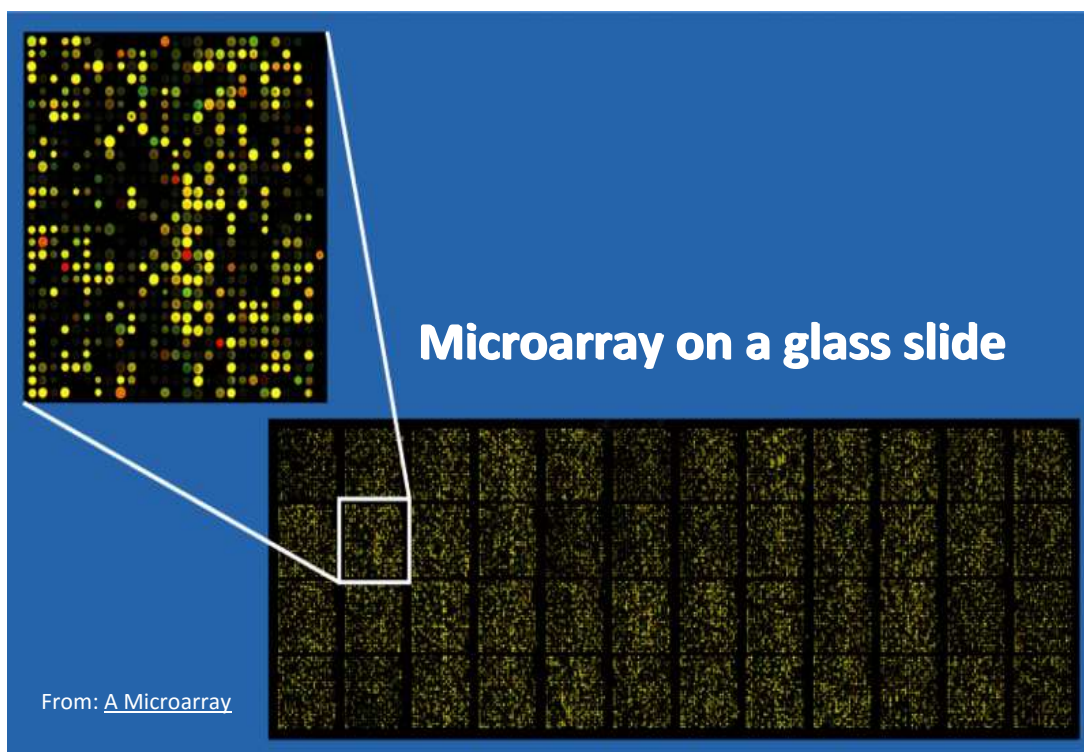

The UV light in the microscope causes spots to fluoresce a different color for each fluorescently tagged target molecule that has hybridized to probe sequences on the microarray. When quantitative microarray procedures are used, the brightness of the signal from each probe can be measured and is an indication of the amount of nucleic acid bound to the spot on the array, or the relative amounts of cDNA (and therefore RNA) from different tissues or tissue treatments hybridizing to the same spot on identical microarrays. On the next page is a table of different applications of microarrays (adapted from Wikipedia).

Application or technology	Synopsis
Gene expression profiling	In a transcription (mRNA or gene expression) profiling experiment the expression levels of thousands of genes are simultaneously monitored to study the effects of certain treatments, diseases, and developmental stages on gene expression.
Comparative genomic hybridization	Assessing genome content in different cells or closely related organisms, where one organism's genome is the probe for a target genome from a different species.
GeneID	Small microarrays to check IDs of organisms in food and feed for genetically modified organisms (GMOs), <u>mycoplasmas</u> in cell culture, or pathogens for disease detection. These detection protocols often combine PCR and microarray technology.
Chromatin immunoprecipitation on Chip (ChIP)	DNA sequences bound to a particular protein can be isolated by <u>immunoprecipitating</u> that protein. These fragments can be then hybridized to a microarray (such as a <i>tiling array</i>) allowing the determination of protein binding site occupancy throughout the genome.
DamID	Analogously to ChIP, genomic regions bound by a protein of interest can be isolated and used to probe a microarray to determine binding site occupancy. Unlike ChIP, DamID does not require antibodies but makes use of adenine methylation near the protein's binding sites to selectively amplify those regions, introduced by expressing minute amounts of protein of interest fused to bacterial DNA adenine methyltransferase .
SNP detection	Identifying single nucleotide polymorphism among alleles within or between populations. Several applications of microarrays make use of SNP detection, including Genotyping, forensic analysis, measuring predisposition to disease, identifying drug-candidates, evaluating <u>germline</u> mutations in individuals or <u>somatic</u> mutations in cancers, assessing loss of heterozygosity , or genetic linkage analysis.
Alternative splicing detection	An exon junction array design uses probes specific to the expected or potential splice sites of predicted exons for a gene. It is of intermediate density, or coverage, to a typical gene expression array (with 1-3 probes per gene) and a genomic tiling array (with hundreds or thousands of probes per gene). It is used to assay the expression of alternative splice forms of a gene. Exon arrays have a different design, employing probes designed to detect each individual exon for known or predicted genes, and can be used for detecting different splicing isoforms.
Tiling array	Genome tiling arrays consist of overlapping probes designed to densely represent a genomic region of interest, sometimes as large as an entire human chromosome. The purpose is to empirically detect expression of transcripts or alternatively spliced forms which may not have been previously known or predicted.

VII. From Genetic Engineering to Genetic Modification

By enabling us to focus on how genes evolve, how they are regulated and how their regulation has evolved, these and other DNA technologies have vastly increased our knowledge of how cells work at a molecular level. We continue to add to our knowledge of disease process and in at least a few cases, how we can treat disease. The use of technology to genetically modify organisms is more controversial, despite the best of human intentions. Some of these genetically modified organisms (GMOs) aim to increase food productivity to better feed the world. They include the introduction of 'beneficial' genes that make

- drought-resistant crops to increase the range in which important food crops can be grown.
- pest-resistant crops to reduce reliance on environmentally toxic chemical pesticides.
- herbicide-resistant crops that survive when chemicals are used to destroy harmful plants.

The quest for "improved" plant and animal varieties has been ongoing since before recorded history. Farmers have been cross-breeding cows, sheep, dogs, and crop varieties from corn to wheat, hoping to find faster growing, larger, hardier, (you name it) varieties. It is the manipulation of DNA (the essence of the genetic material itself) that is at the root of controversy. Controversy is reflected in opinions that GMO foods are potentially dangerous, and that their cultivation should be banned (the general consensus is that it's too late for that!). The scientific consensus, after many years of GMO crops already in our food stream, is that GMO foods are no more harmful than unmodified foods. In fact, you are probably already partaking of some GMO foods. The current debate is whether or not to label foods as GMO if they have been genetically modified.

In an odd but perhaps amusing take on the discomfort some feel about GMOs, a startup company has genetically modified Petunias. When grown in water, their flowers are white, but when 'watered' with beer, they will produce pink flowers or purple flowers depending on how much beer they get (Check it out at [Can Beautiful Flowers Change Face?](#)). According to the company, they seek "to bring what it sees as the beauty of bioengineering to the general public" (and perhaps some profit as well?).

Some iText & VOP Key Words and Terms

2', 3' di-deoxy CTP chemotherapy	genome	regulatory networks
alternative splicing	genome projects	restriction endonucleases
automated DNA sequencing	genomic library	reticulocyte
autoradiography	insert DNA	reverse transcriptase

BACs and YACs	library screening	RNA probes
bacterial artificial chromosome vectors	linkers	RNAse
blunt ends	Northern blot	shotgun sequencing
cDNA	oligo d(T) column	single nucleotide polymorphisms
cDNA hairpin loop	PCR	SNPs
cDNA library	PCR	Southern blot
cDNA probes	PCR primers	sticky ends
chemiluminescence	PCR steps	systematics
cosmid vectors	phage lambda vectors	Taq polymerase
di-deoxy chain termination	plasmids	thermophilic bacteria
di-deoxy sequencing method	poly(A) tail	thermophilic DNA polymerases
DNA ligase	polymerase chain reaction	<i>Thermus aquaticus</i>
DNA sequencing	primer	transcriptome
elution	primer walking	transformation
ethidium bromide	probe hybridization	vectors
fluorescence	proteome	Western blot
forensics	recombinant vector	yeast artificial chromosome vectors
Genetic (DNA) fingerprint	recombination	

Chapter 14: Membrane Structure

Membrane Structure and Function: the fluid mosaic, membrane proteins, glycoproteins, glycolipids



I. Overview

All intracellular membranes, including the plasma membrane, share a common **phospholipid bilayer** construction. All membranes are a **fluid mosaic** of proteins attached to or embedded in the phospholipid bilayer. The different proteins in cellular membranes are key in making one kind of membrane structurally and functionally different from another. **Integral membrane (Transmembrane) proteins** span the lipid bilayer. They are characterized by a **hydrophobic domain** and two **hydrophilic domains**. In the case of the plasma membrane, the **hydrophilic domains** interact with the aqueous extracellular fluid on one side and the cytoplasm on the other, while a **hydrophobic domain** keeps the proteins attached to the membrane. Once embedded in the fatty acid interior of a membrane, integral membrane proteins cannot escape! **Peripheral membrane proteins** bind to membrane surfaces, typically held in place by hydrophilic interactions between the protein and charged features of the membrane surface (phospholipid heads, hydrophilic surface domains of integral proteins). Recall that extracellular surfaces are “sugar coated” because the integral proteins are often glycoproteins that expose their sugars to the outside of the cell. Thus cells present a **glycocalyx** to the outside world. As cells form tissues and organs, they become bound to extracellular proteins and glycoproteins that they themselves or other cells secrete,

forming an **extracellular matrix**. Using mainly the plasma membrane, we'll look at characteristic structures and biological activities of membrane proteins that inform their specific functions.

Voice-Over PowerPoint Presentations

[Membrane: Basic Structure](#)

[Membranes: Structure of Membrane Proteins](#)

Learning Objectives

When you have mastered the information in this chapter and the associated VOPs, you should be able to:

1. distinguish components of the membrane that can move (diffuse) laterally in the membrane from those that can *flip* (switch from the outer to the inner surface of the phospholipid bilayer)
2. compare the fluid mosaic membrane to earlier membrane models and cite the *evidence* for and against each (as appropriate)
3. describe how the plasma membrane is made by the cell, and suggest an experiment that would demonstrate your *hypothesis*
4. distinguish between *transmembrane* and *peripheral* membrane proteins, provide specific examples of each
5. decide whether or not a newly discovered protein might be a membrane protein
6. predict the effect of *molecular* and *physical influences* on membrane fluidity
7. suggest how organisms living in *warm tropical waters* have adapted to the higher temperatures. Likewise, fish living under the *arctic ice*
8. explain how *salmon* are able to spend part of their lives in the ocean and part swimming upstream in freshwater to spawn without their cells shriveling or exploding
9. list the diverse *functions* of membrane proteins
10. speculate on why only eukaryotic cells have evolved to have *sugar-coated cell surfaces*
11. compare and contrast the glycocalyx and extracellular matrix of some cells

II. [Plasma Membrane Structure](#) (Click to see Boundless.com's description)

The cell or *plasma membrane* surrounds the cytoplasm within cells, which in eukaryotes is filled with membrane-bound organelles. All cellular membranes are selectively permeable (semi-permeable), allowing only certain substances to cross the membrane. All cellular membranes are composed of two layers of phospholipids embedded with proteins and glycoproteins. Different phospholipid and protein compositions give different cellular membranes their unique functions. Decades of research have revealed these functions (see earlier discussions of mitochondrial and chloroplast function for instance). Here we will describe general features of membranes, using the plasma membrane as our example.

A. The Phospholipid Bilayer

A bilayer membrane structure was predicted by Gorter and Grendel as early as 1925. They knew that red blood cells (erythrocytes) have no nucleus or other organelles, and thus have only a plasma membrane. They also knew that a major chemical component of these membranes were lipids, specifically **phospholipids**. Basic phospholipid structure as we understand it today is shown in the space-filling molecular model below, highlighting its **hydrophilic** (polar) head and **hydrophobic** tails. Molecules with hydrophilic and hydrophobic domains are called **amphipathic**.

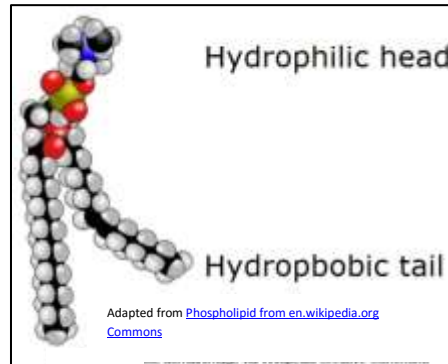

By the early 1900s, Gorter and Grendel had experimentally measured the surface area of red blood cells, disrupted them and calculated the amount of phospholipids in the membranes that remained. Although Gorter and Grendel made two calculation errors, their mistakes compensated each other. So their estimate that there were enough lipid molecules per cell to wrap around each cell twice was prophetic if not strictly speaking, 'correct'! Common membrane phospholipids are shown below.

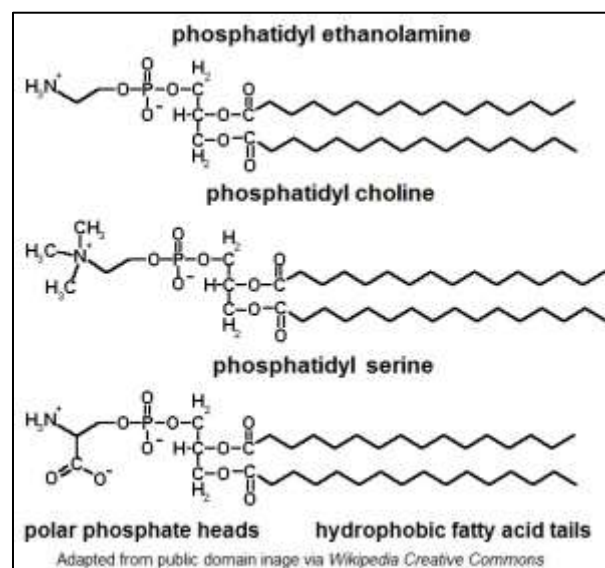

When amphipathic molecules are mixed with water they will spontaneously aggregate to 'hide' their hydrophobic regions from the water. Phospholipids in water will aggregate so that polar heads face away from each other and the hydrophobic tails interact with each other. Knowledge that membranes were composed of phospholipids led to a picture of membrane architecture based on phospholipid interactions (below).

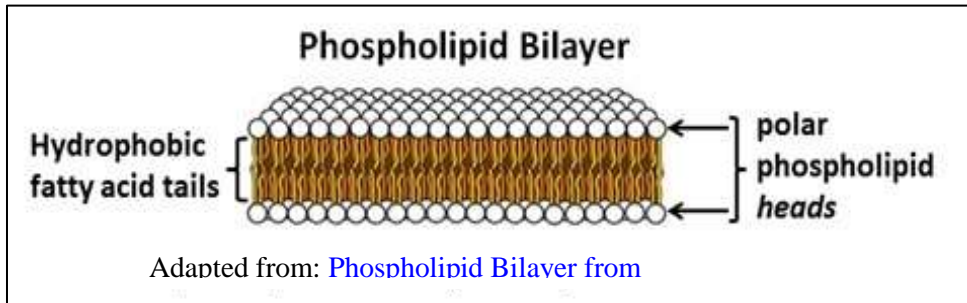

B. Models of Membrane Structure

In 1935, Davson and Danielli suggested that proteins might be more or less fortuitously bound to the polar heads of the phospholipids. J.D. Robertson first observed membranes in the transmission electron microscope at high power some decades later, revealing them to have a *trilamellar* structure (below).

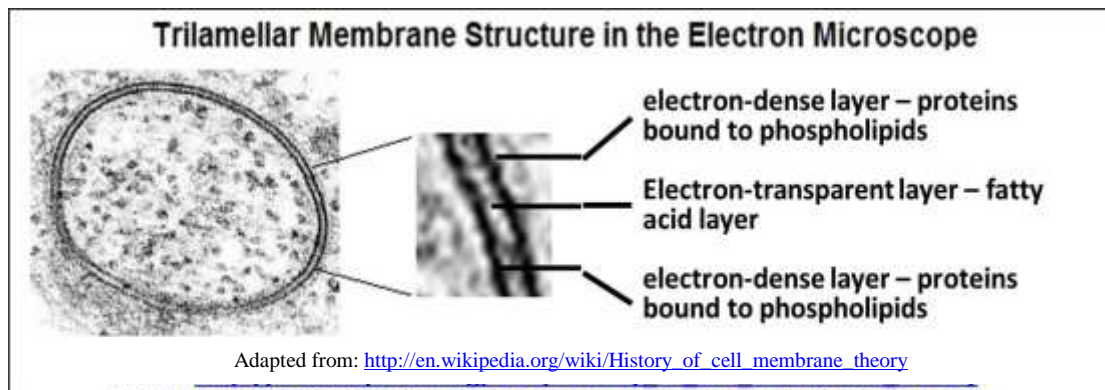

The *trilamellar* structure was consistent with the biochemical evidence of a phospholipid bilayer in which the clear layer was interpreted as the lipid region of the membrane. The electron-dense regions facing the aqueous regions inside and outside the cell would be the polar heads of the phospholipids, associated with the polar surfaces of proteins. This seemed to confirm the Davson-Danielli model, though Robertson offered his *Unit Membrane* theory in which only proteins with specific functions associated with a membrane were actually bound to the phospholipid heads.

The static view of the trilamellar models of membrane structure implied by the Davson-Danielli or Robertson models were replaced in 1972 when Singer and Nicolson proposed the **Fluid Mosaic** model of membrane structure (see Singer SJ and Nicolson GL (1972) *The fluid mosaic model of membranes*. Science 175:720-731). They suggested that in addition to **peripheral proteins** that *do* bind to the surfaces of membranes, many **integral membrane proteins** actually span the membrane. **Integral membrane proteins** were imagined as a *mosaic* of protein ‘tiles’ embedded in a phospholipid medium. But unlike a mosaic of glazed tiles set in a firm, cement-like structure, the protein ‘tiles’ were predicted to be mobile (fluid) in a *phospholipid sea*. The key to the fluid mosaic is that embedded proteins are held in membranes by a *hydrophobic* domain, while they expose their *hydrophilic* domains to the external aqueous and cytosolic environments. Thus, like phospholipids themselves, membrane proteins are *amphipathic*. Because the hydrophilic domains of each integral membrane protein are different from each other, we say that cellular membranes are **asymmetric**. In other words, cells expose different surface structural (and functional) features to opposite sides of the membranes.

A typical model of the plasma membrane of a cell is illustrated below (peripheral proteins are designated as a “Surface protein”).

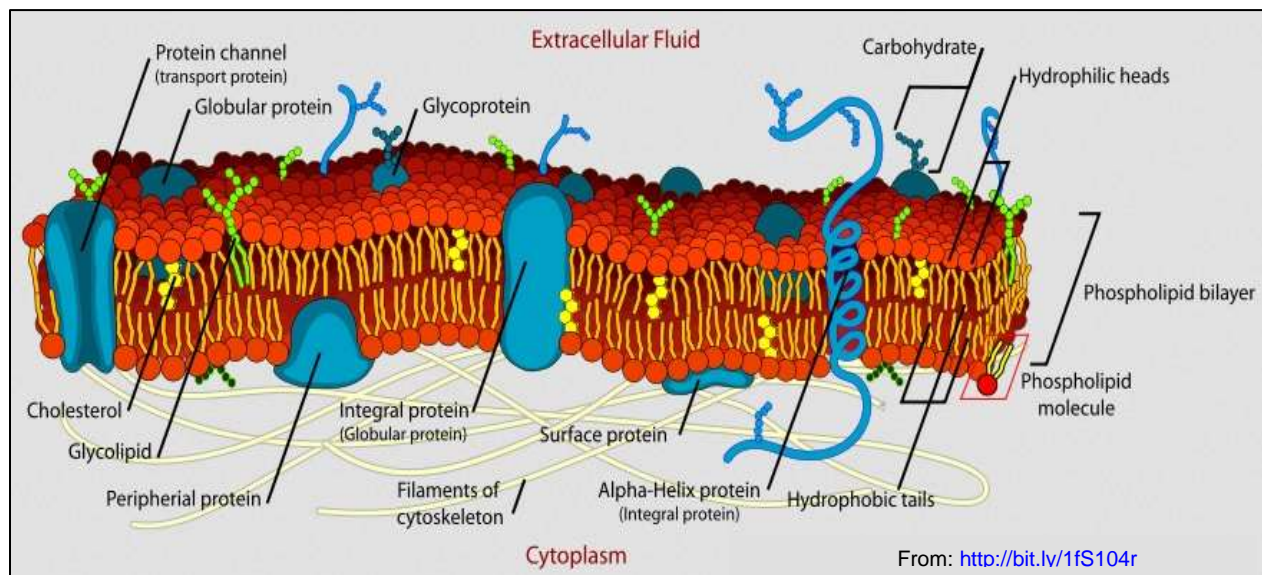

Because of their own aqueous hydrophilic domains, membrane proteins are a natural barrier to the free passage of charged molecules across the membrane. On the other hand, membrane proteins are responsible for the **selective permeability** of membranes, facilitating the movement of *specific* molecule in and out of cells. Membrane proteins also account for specific and selective interactions with their extracellular environment, including the adhesion of cells to other cells, their attachment to surfaces, communication

between cells (both direct and via hormones and neurons), etc.. The extracellular surface of plasma membranes is 'sugar-coated' with **oligosaccharides** covalently linked to membrane proteins (as **glycoproteins**) or to phospholipids (as **glycolipids**). The carbohydrate components of **glycosylated** membrane proteins inform their function. For example, the glycoproteins enable specific interaction of cells with each other to form tissues. They also allow interaction with extracellular surfaces to which they must adhere. And they figure prominently as part of receptors for many hormones and other chemical communication biomolecules. Protein domains exposed to the cytoplasm are not glycosylated. They are often connected to components of the cytoskeleton, giving cells their shape and allowing cells to change shape when necessary. Many membrane proteins have essential enzymatic features, as we will see. Given the crucial role of proteins and glycoproteins in membrane function, it should come as no surprise that proteins constitute an average of 40-50% of the mass of a membrane. In some cases, proteins are as much as 70% of membrane mass (think cristal membranes in mitochondria!).

C. Evidence for Membrane Structure

Integral membrane proteins are also called **trans-membrane proteins**. The fact that different membrane features face opposite sides of the membrane (membrane *asymmetry*) was demonstrated directly by the scanning electron microscope technique of **freeze-fracture**. The technique involves freezing of isolated membranes in water and then chipping the ice. When the ice cracks, the encased membranes split along a *line of least resistance*... which turns out to be between the fatty acids in the interior of the membrane. Scanning electron microscopy then reveals features of the interior and exterior membrane surfaces (cartooned below).

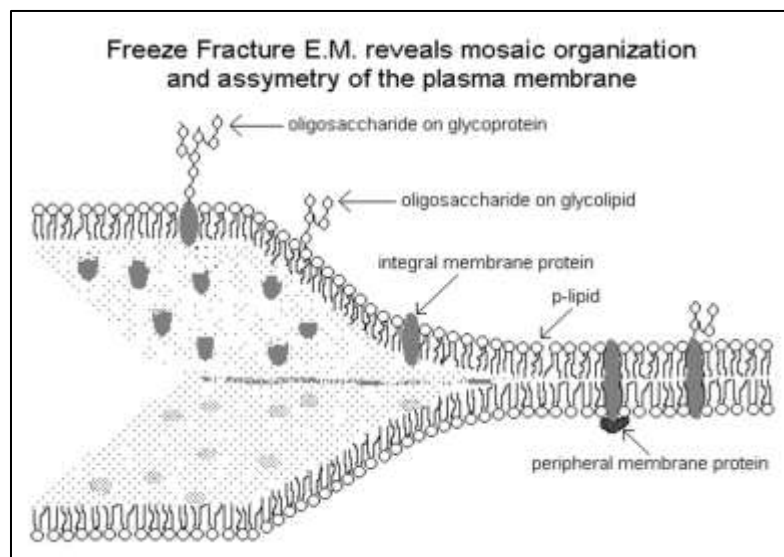

The asymmetry of membranes was also demonstrated biochemically. Whole cells or a plasma membrane fraction of the cells were treated with proteolytic enzymes. Next, each experimental *membrane digest* was extracted and the remnant membrane proteins separated by size on an electrophoretic gel. The results demonstrated that different components of integral membrane proteins were present in the two digest experiments. The idea that membranes are *fluid* was of course, also tested.

CHALLENGE: OK, for intact cells only parts of proteins exposed to the outside of the cell will be digested. But treatment of an isolated cell membrane fraction with the same enzyme will digest portions of integral proteins facing both sides of the membrane. The proteins remaining in the membranes after the digestions were extracted and electrophoresed to separate them by size. What would you expect to see on such gels when these digested membrane protein extracts are run side by side?

In one elegant experiment, antibodies were made to mouse and human cell membrane proteins. Membranes were isolated and injected into a third animal (a rabbit most likely). The rabbit saw the membranes and their associated proteins as foreign and responded by making specific anti-membrane antibody molecules. The antibodies against each membrane source were isolated and separately tagged with different colored fluorescent labels so that they would glow a different color when subjected to ultraviolet light. Finally, mouse and human cells were mixed under conditions that caused them to fuse, making human-mouse hybrid cells.

When the tagged antibodies were added to these fused cells, they bound to the cell surface proteins. Viewed in a fluorescence microscope under UV light, the mouse antibodies could be seen at first on one side of the hybrid cell, and the human antibodies could be seen on the other. But after a short time, the different fluorescent antibodies became more and more mixed. Clearly, proteins embedded in the membrane are not static, but are able to move laterally in the membrane, in effect diffusing within a “sea of phospholipids”. This is animated in a cartoon at the following link:

<http://youtu.be/oGsET23q-e0>

D. Membrane Fluidity is Regulated

1. Chemical Factors Affecting Membrane Fluidity

As you might imagine, just how fluid a membrane is depends on what’s in the membrane and (for cold-blooded organisms) the temperature of the environment.

Factors affecting fluidity are summarized below.

**Membrane fluidity depends on T,
f.a. saturation and cholesterol:**

- higher *T* leads to increased fluidity
- more *unsaturated* fatty acids leads to more fluidity
- more *cholesterol* stiffens membranes by filling in gaps between p-lipids, decreasing fluidity

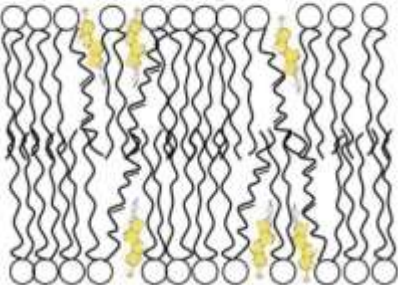

Since higher temperatures result in more molecular motion, membrane phospholipid *and* protein components of the membrane would be more fluid (move faster). Fatty acid tails with more unsaturated C-C bonds (especially polyunsaturated fatty acids) have more kinks, or bends. These will tend to push apart the hydrophobic tails of the phospholipids, creating more space between them, again allowing for more movement of membrane components. On the other hand, cholesterol molecules tend to fill the space between fatty acids in the hydrophobic interior of the membrane, reducing the lateral mobility of phospholipid and protein components in the membrane. In so doing, cholesterol makes membranes less fluid and reduces membrane permeability to some ions.

2. **Functional Factors Affecting Membrane Fluidity**

Evolution has adapted cell membranes to different and changing environments to maintain the fluidity necessary for proper cell function. Cold-blooded or ***poikilothermic*** organisms, from prokaryotes to fish and reptiles, do not regulate their body temperatures. Thus, when exposed to lower temperatures, *poikilotherms* respond by increasing the *unsaturated* fatty acid content of their cell membranes; at higher temperatures, they increase membrane *saturated* fatty acid content. For example, the cell membranes of fish living under the arctic ice maintain fluidity by having high levels of both monounsaturated and polyunsaturated fatty acids. But for fish species that *range* across warmer and colder environments (or that live in climates with changing seasons) membrane composition can change to adjust fluidity.

Warm-blooded, **homeothermic** organisms that maintain a more or less constant body temperature have less need to regulate membrane composition. But in an apparent paradox, even though cells of **homeotherms** (mammals and birds) are in warm internal environments, their cell membranes have a higher ratio of *polyunsaturated* fat to *monounsaturated* fats than say, reptiles. The resulting greater membrane fluidity supports the *higher metabolic rate* of the warm-blooded species compared to poikilotherms. Just compare the life styles of almost any mammal to a lazy alligator!

E. Making and Experimenting with Artificial Membranes

Membrane-like structures can form spontaneously. When phospholipids interact in an aqueous environment, they aggregate to exclude their hydrophobic fatty tails from water, forming spherical phospholipid monolayers by *self-assembly*, a natural aggregation of these amphipathic molecules. Called **micelles**, these monolayer spheres can further self-assemble into spherical phospholipid bilayers called **liposomes** (below).

When mixed in water, the phospholipids form bilayer spheres. These synthetic structures are called liposomes.

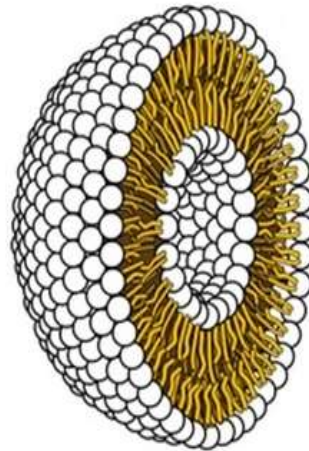

Adapted from: [Phospholipid Bilayer from en.wikipedia.org](https://en.wikipedia.org/wiki/Phospholipid_Bilayer)

When they are formed in the laboratory, these structures behave somewhat like cells. They can be centrifuged to form a pellet at the bottom of a centrifuge tube. Liposomes can be custom designed from different kinds of phospholipids and amphipathic proteins that become integral to the liposome membranes. And they can be made to contain specific proteins or other molecules within the structure that cannot cross membranes. Such were the studies that allowed the identification of the mitochondrial respiratory chain complexes. The ability to manipulate liposome content and membrane composition make them candidates for the drug delivery to specific cells and tissues (*google liposome for more information!*).

F. The Plasma Membrane is Segregated into Regions with Different Properties of Fluidity and Selective Permeability

As we will see shortly, fluidity *does not* result in an equal diffusion of all membrane components around the cell membrane surface. Instead, extracellular connections between cells as well as intracellular connections of the membrane to differentiated regions of the cytoskeleton effectively compartmentalize the membrane into sub-regions. Just imagine a sheet of epithelial like those in the cartoon below.

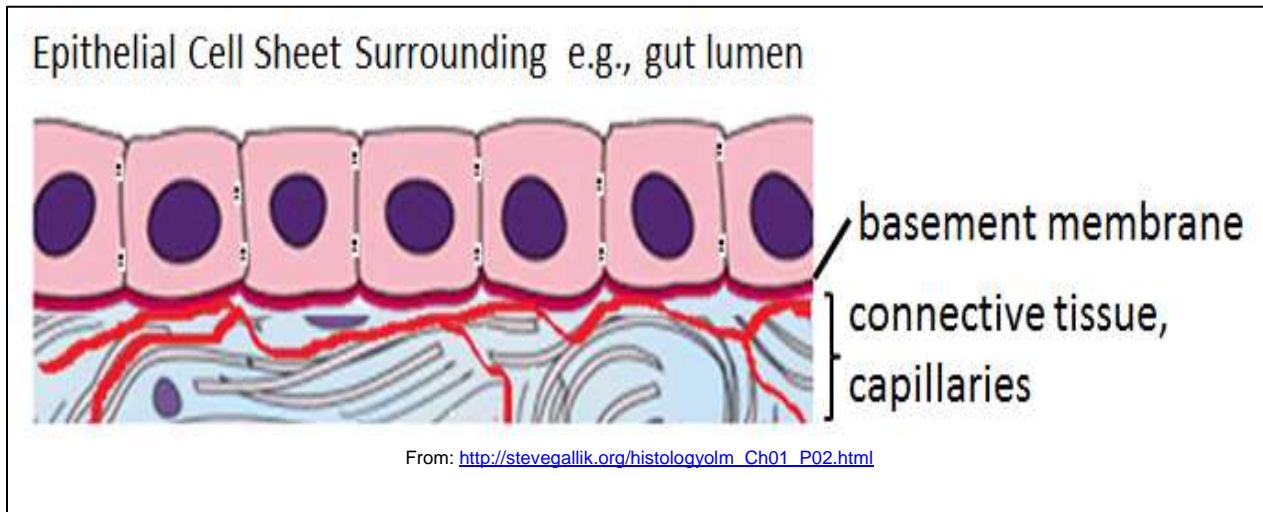

The cells expose surfaces with unique functions to the inside of the organ they line, and one with a quite different function on the other side of the sheet. The lateral surfaces of the cells are yet another membrane compartment, one that functions to connect and communicate between the cells in the sheet. Components within a compartment may remain fluid, but each compartment serves a unique function. This *macro-differentiation* of cell membranes to permit cell-cell interactions makes intuitive sense.

The recent observation that cellular membranes are even more compartmentalized was perhaps less anticipated. In fact, membranes are divided into micro-compartments within which components are fluid but across which components seldom mix. Recent studies indicate that cytoskeletal elements create and maintain these micro-discontinuities.

When integral membrane proteins are attached to cytoskeletal fibers (e.g., actin) they are immobilized in the membrane. Furthermore, when aggregates of these membrane proteins line up due to similar interactions, they form kind of fence, inhibiting other membrane components from crossing. By analogy, this mechanism of micro-compartmentalization was called the *Fences and Pickets model*, with the proteins

attached to the cytoskeleton serving as the pickets. The infrequent movement across the fences was infrequent; their motion was called *hop diffusion*, to distinguish this motion from the Brownian motion implied by the original fluid mosaic model.

III. Membrane Proteins (Click to see Boundless.com's description)

Proteins may be anchored to membranes in several ways. Integral membrane proteins are not covalently linked to membrane lipids, but because they are amphipathic, they have hydrophobic domains that interact strongly with the fatty acid interior of membranes. Some integral membrane proteins span the entire membrane, with hydrophilic domains facing the cytosol or cell exterior. Peripheral proteins are held to the surface of membranes through non-covalent interactions, and are typically dissociable from the membrane. Membrane lipoproteins are proteins covalently linked to fatty acids in the membrane interior. These membrane protein types are illustrated below.

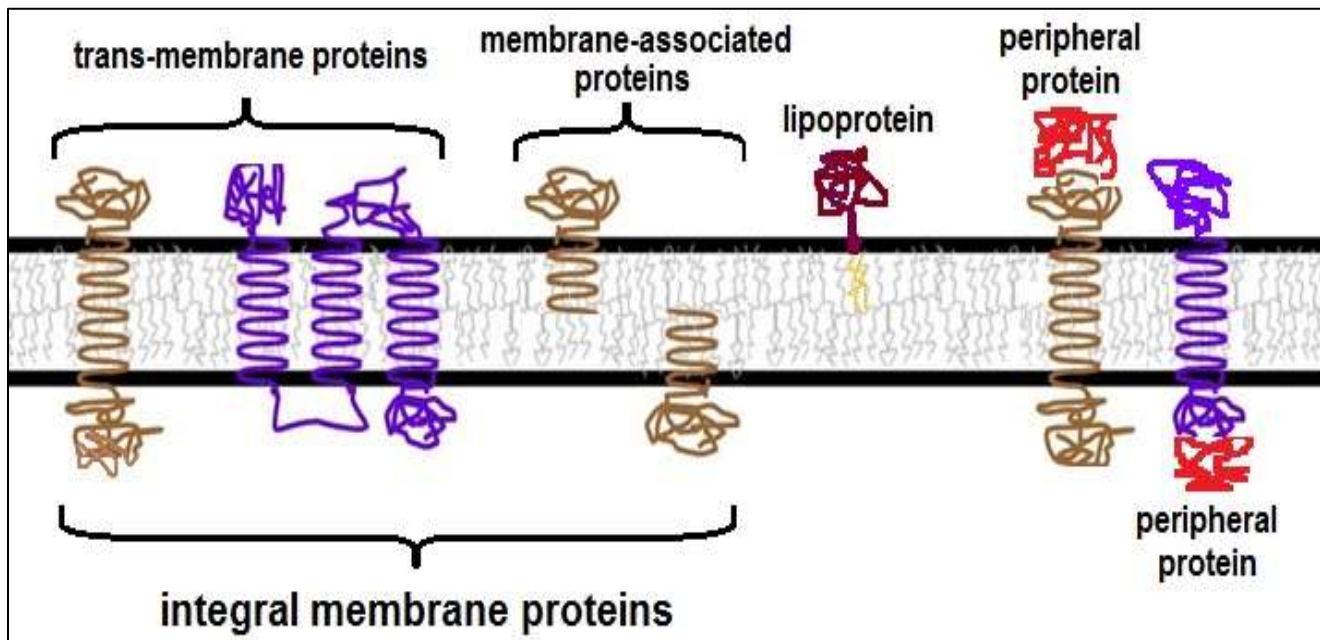

Membrane proteins function as receptors for hormones or neurotransmitters, as antibodies, as cell-recognition molecules that bind cells together, as cell-cell communication structures that pass chemical information between cells, as anchors to extracellular surfaces like connective tissue, as transporters allowing the entry into or exit of substances from cells, even as enzymes that catalyze crucial reactions in cells.

Some of these functions are summarized and illustrated below.

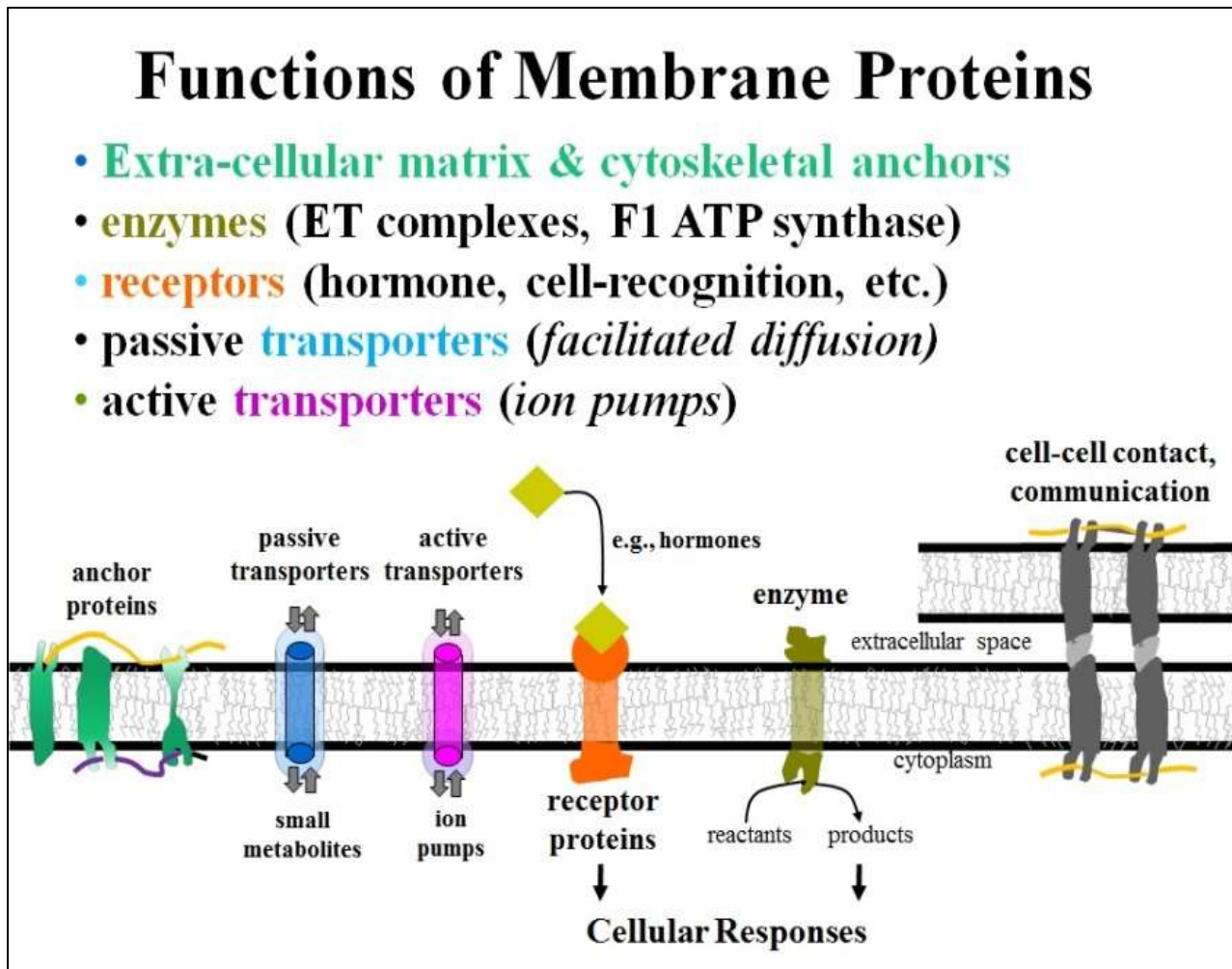

Most of the functions illustrated here are performed by transmembrane proteins. However, peripheral membrane proteins also play vital roles in membrane function. Cytochrome c in the electron transport system on the mitochondrial cristal membrane is a peripheral protein. Other peripheral membrane proteins may serve to regulate the transport or signaling activities of transmembrane protein complexes or may mediate connections between the membrane and cytoskeletal elements. Peripheral membrane proteins by definition do not penetrate membranes. They bind reversibly to the internal or external surfaces of membranes the biological membrane with which they are associated. We'll be looking more closely at how membrane proteins are held in membranes and how they perform their unique functions. For now, check out the table on the next page, listing major membrane protein functions, their actions and where they act.

Some Functions of Membrane Proteins

Basic Function	Specific Actions	Examples
Facilitated transport	Regulate diffusion of substances across membranes along a concentration gradient	Ca ⁺⁺ & other ion channels, glucose transporters
Active transport	Use energy to move ions from low to high concentration across membranes	Mitochondrial protein pumps, the Na ⁺ /K ⁺ ion pump in neurons
Signal transduction	For e.g., hormones that can't enter cells, these convey information from molecular signals to cytoplasm, leading to a cellular response	Protein hormone and growth factor signaling, antibody/antigen interactions, cytokine mediation of inflammatory responses etc.
Cell-cell interactions	Cell-cell recognition and binding to form tissues	Formation of desmosomes, gap junctions and tight junctions
Anchors to cytoskeleton	Link membrane proteins to cytoskeleton	Give cells their shape, cell movement and response to molecular signals
Enzymatic	Usually multifunctional proteins with enzymatic activities	The F ₁ ATP synthase that uses proton gradient to make ATP; adenylyl cyclase that makes cAMP during signal transduction; note that some receptor proteins are linked to enzymatic domains in the cytoplasm.

A. How membrane proteins are held in membranes

As already noted, membrane proteins are *amphipathic*. The hydrophobic domain of integral membrane proteins consists of one or more alpha-helical regions that interact with the hydrophobic interior of the membrane, while hydrophilic domains face the aqueous cytosol and cell exterior. Two trans-membrane proteins are cartooned below.

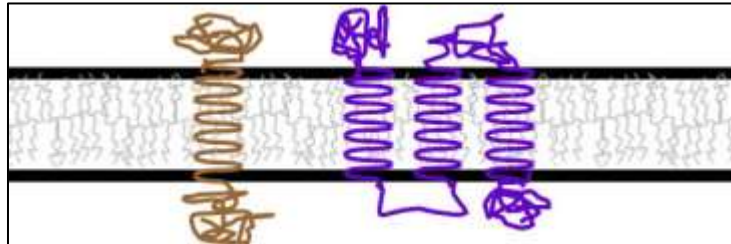

The protein on the left crosses the membrane once, while the one on the right crosses the membrane three times. The locations of the N-terminus and C-terminus of a transmembrane polypeptide are dictated by how the protein is inserted into the membrane during synthesis and by how many times the protein crosses the membrane. As you will see, the N-terminal end of a plasma membrane polypeptide is inserted into the membrane such that it will always be exposed to the outside of the cell.

CHALLENGE (Try your hand at this!): Can the C-terminal end of a membrane polypeptide ever face outside of a cell?

The alpha helical domains that anchor proteins in a membrane are mostly non-polar, and hydrophobic themselves. As an example, consider the amino acids in the alpha-helical domain of the red blood cell protein *glycophorin A* (below) that prevents red blood cells from aggregating, or clumping in the circulation.

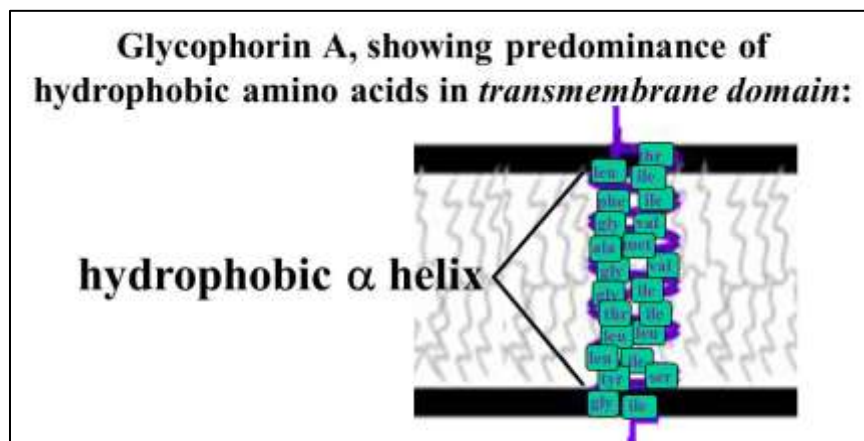

Proteins that span membranes multiple times may include amino acids with charged, polar side chains, provided that these side chains interact between helices so that they are shielded from the fatty acid environment in the membrane. Because of these hydrophilic interactions, such proteins can create **pores** for the **transport** of polar molecules and ions. Integral membrane proteins that do not span the membrane still have a helical hydrophobic domain that anchors them in the membrane. These membrane proteins typically interact with intracellular or extracellular molecules to hold cells in place or otherwise give cells and tissues their structure.

The very presence of the hydrophobic alpha-helical domains in trans-membrane proteins makes them difficult if not impossible to isolate from membranes in a biologically active form. By contrast, the peripheral polypeptide cytochrome c readily dissociates from the cristal membrane, making it easy to purify. For many years our understanding of the structure and function of the mitochondrial electron transport system was limited by an inability to purify the other biologically active electron carriers in the cristal membrane.

Hydrophobic alpha-helical domains are in fact a *defining hallmark* of membrane-spanning proteins. These days, it is possible to determine the primary structure of a polypeptide encoded by a gene even before the protein itself is discovered. For example, when the sequence of a newly discovered polypeptide is identified following genome sequencing, the amino acid sequence of the protein can be inferred from the coding region of the gene. A *hydrophobicity* analysis of the inferred amino acid sequence can tell us if the protein encoded by the gene is likely to be a membrane protein. Let's look at a **hydropathy** (*hydrophobicity*) plot (below).

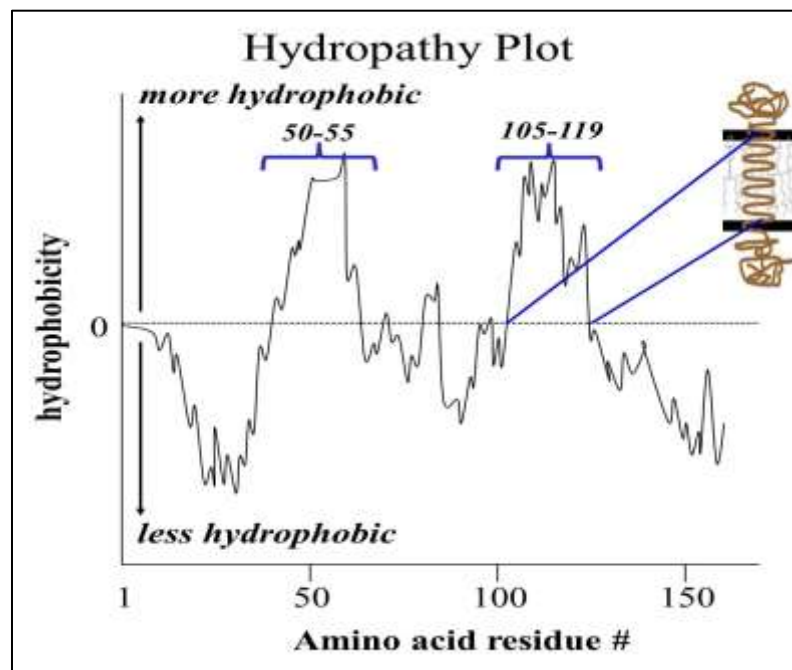

B. Glycoproteins

Membrane proteins are often covalently linked to **oligosaccharides**. These oligosaccharides are called **glycans**, and sugar-linked proteins are therefore called **glycoproteins**. Glycoproteins are rare in the cytosol, but common on secreted proteins and membrane proteins. The oligosaccharides are branched *glycoside-linked* sugars (averaging around 15 sugar residues), typically linked via the hydroxyl group on *serine* or *threonine*. Less frequent linkages are to modified amino acids like *hydroxylysine* or *hydroxyproline* (*O-glycosylation*), and occasionally via the amide nitrogen on asparagine (*N-glycosylation*). As already noted, the oligosaccharide domains of glycoproteins typically play a major role in membrane protein function. Along with the extracellular polar domains of integral and peripheral proteins and glycolipids, glycoproteins are a major feature of the **glycocalyx** (below).

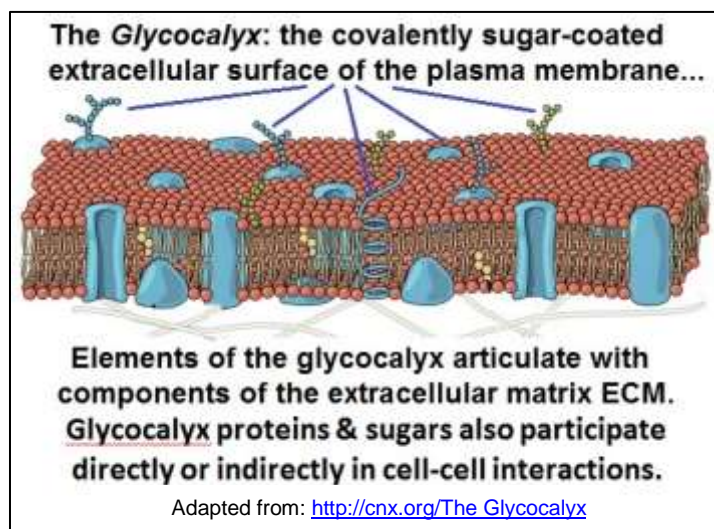

The oligosaccharides begin their synthesis in the rough endoplasmic reticulum (*RER*), with the creation of a **core glycoside**. This partial glycan is enzymatically linked to one of several amino acids of a membrane protein. As these proteins travel through the *Golgi vesicles* of the *endomembrane system*, more sugars are added to the core glycoside in a process called terminal glycosylation. The process, which explains why cells are 'sugar coated' is demonstrated in the animation at this link: <http://youtu.be/TkHNC8ePMPE>.

Membrane glycoproteins and glycolipids enable cell-cell recognition. The O, A, B and AB *blood groups* in humans are an example in which red blood cells are characterized by different cell surface antigens that keep them from clumping unless mixed inappropriately. That's why blood is 'typed' before giving patients a transfusion. Other functions include white blood cell surface antibodies that recognize foreign substances (antigens) in the

blood and immunoglobulins (circulating antibodies that also recognize antigens), and cell-surface molecules of the major histocompatibility complex (MHC). Because organs from incompatible donors will be rejected, tissue typing determines if MHC proteins are compatible between a donor and recipient prior to an organ transplant. Many secreted proteins (e.g., hormones) are also glycoproteins, as are those that bind to extracellular surfaces.

C. Glycolipids

Glycolipids are phospholipids attached to oligosaccharides, and as noted, are part of the glycocalyx. Both are only found on the extracellular surface. Glycolipids are synthesized in much the same way as glycoproteins. Specific enzymes catalyze initial glycosylation of either phospholipids or polypeptides, followed by the addition of more sugars. Along with glycoproteins, glycolipids play a role in cell-cell recognition and the formation of tissues. The glycans on the surfaces of one cell will recognize and bind to carbohydrate receptors (**lectins**) on adjacent cells, leading to cell-cell attachment as well as intracellular responses in the interacting cells. Glycoproteins and glycolipids also mediate the interaction of cells with extracellular molecular signals and with chemicals of the **extracellular matrix** (below).

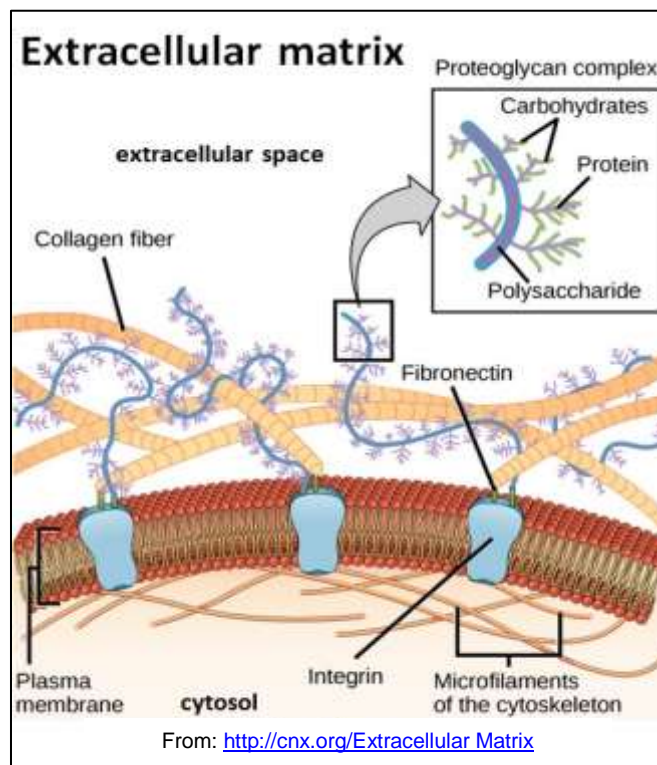

The *extracellular matrix* includes components of connective tissue, basement membranes, in fact any surfaces to which cells attach. In the next chapter we will look more closely at the functions of membranes and their proteins.

Some iText & VOP Key Words and Terms

amphipathic molecules	glycolipids	peripheral membrane proteins
asparagine	glycosylation	phospholipid bilayer
cell membrane	Golgi vesicles	plasma membrane
cell-cell attachment	Hydrophathy plot	poikilothermic organisms
cytoskeleton	hydrophilic phosphate heads	RER
Davson–Danielli membrane model	hydrophobic fatty acid tails	Rough endoplasmic reticulum
endomembrane system	hydrophobicity plot	saturated fatty acids
exocytosis	hydroxyproline	serine
extracellular matrix (ECM)	hydroxylysine	temperature effects on membranes
fluid mosaic	integral membrane proteins	threonine
freeze fracture method	membrane asymmetry	transmembrane proteins
membrane evolution	membrane proteins	unsaturated fatty acids
glycan	N-glycosylation	
glycocalyx	O-glycosylation	

Chapter 15: Membrane Function

Passive, facilitated and active transport, the traffic of proteins in cells, cell-cell interactions, excitability and signal transduction

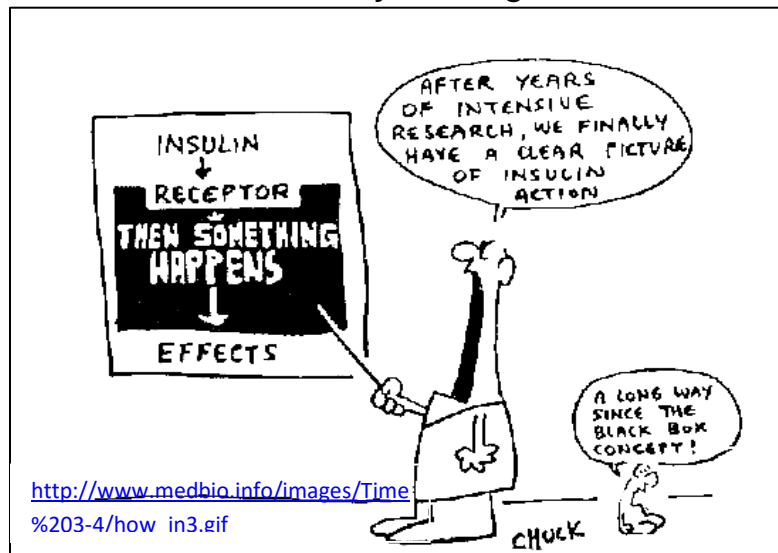

I. Introduction

Small molecules like O_2 or CO_2 can cross cellular membranes unassisted; neither the hydrophilic surfaces nor the hydrophobic interior of the phospholipid bilayer are barriers to their transit. On the other hand, most molecules (even water!) need the help of *membrane transport proteins* to get in or out of cells and organelles. Such *facilitated transport* proteins can act as *gates* that might be open or closed. When open, they permit diffusion of molecules into or out of cells along a concentration gradient so that their concentrations equalize across the membrane. Like the *passive diffusion* of small gasses, *facilitated diffusion* does not require an input of energy. In contrast, some transport proteins are actually *pumps*, using chemical energy to move molecules against a concentration gradient by *active transport* so that they are at higher concentration on one side of the membrane. For example, pumps that create sodium and potassium ion gradients are responsible for the fact that cells are *excitable*. Recall that this is one of the fundamental properties of life: the ability of cells and organisms to respond to stimuli. We'll see such *gates* and *pumps* in action in this chapter, as well as examples of membrane proteins involved in cell-cell interactions, allowing their assembly into tissues and organs. We'll also look at how cells direct proteins appropriately to the cytoplasm, into organelles into membranes... or out of the cell. We'll see how membrane proteins participate in intercellular communication as well as the response of cells to external chemical signals such as neurotransmitters, hormones, and other *effector* molecules. As you read this chapter, look for how allosteric change enables regulation of the function of membrane proteins.

Voice-Over PowerPoint Presentations

[Membranes: Transport](#)

[Membranes: Potential & Excitation](#)

[Membranes: Directing Protein Traffic in Cells](#)

[Membranes: Cell-Cell Communication, the Cell Surface and Cell Junctions](#)

[Membranes: Intercellular Communication & Signal Transduction](#)

Learning Objectives

When you have mastered the information in this chapter and the associated VOPs, you should be able to:

1. explain how and why one cell's plasma membrane differs from that of a different cell type
2. explain how and why the plasma membrane differs from other membranes in the cell
3. determine if a solute is crossing the plasma membrane by passive or facilitated diffusion
4. explain how *salmon* are able to spend part of their lives in the ocean and part swimming upstream in freshwater to spawn without their cells shriveling or exploding
5. explain the role of *active transport* in storing *chemical energy* (recall electron transport)
6. explain the role of active transport in maintaining or restoring a cell's *resting potential*
7. compare and contrast different kinds of *gated channels*
8. describe in order the ion movements that generate an *action potential*
9. compare and contrast *exocytosis*, *pinocytosis*, *phagocytosis* and *receptor-mediated endocytosis*
10. distinguish between *signal molecules* that enter cells to deliver their chemical message and those deliver their message only to the plasma membrane
11. trace an intracellular response to a *steroid hormone* to its most likely *cellular effect*
12. trace the response of a liver cell to *adrenalin* from the plasma membrane to the *breakdown of glycogen*
13. compare the *signal transduction* activities of different *G-protein receptors* leading to the first active kinase enzyme
14. explain the molecular basis of a liver cells *identical response to two different hormones* (i.e., adrenalin and glucagon)
15. Describe/explain how a phosphorylation cascade *amplifies* a cellular response to a small amount of an effector (signal) molecule
16. discuss the difference and interactions between the *glycocalyx*, *basement membrane* and *extracellular matrix* (ECM)
17. explain the functions of the *ECM* and identify components involved in those functions
18. describe how the molecular structure of *fibronectin* supports its different functions
19. speculate about the structural relationship between cell surface and the *cytoskeleton*

20. compare and contrast the structures and functions of the different cell junctions.
21. distinguish between the structures and functions of *cadherins*, clathrin, COPs, adaptin, *selectins*, *SNAREs* and *CAMs*
22. state an hypothesis to explain why some cancer cells divide without forming a tumor

I. Membrane Transport

Molecules move in and out of cells in one of 3 ways: ***passive diffusion***, ***facilitated transport*** and ***active transport***. The first two release free energy; active transport consumes it. The first control on the passage of molecules across membranes is the semi-permeable character of the membrane itself. Only a few small relatively uncharged molecules can cross a membrane unassisted (i.e., by passive diffusion). And only specific hydrophilic molecules are allowed to cross cellular membranes. That specificity resides in the integral membrane proteins of ***facilitated transport*** and ***active transport***. For a long time, water was thought by many to cross membranes unassisted. And indeed it does so... to a limited extent. But water is a small and highly charged *polar covalent* molecule, and some suspected that water would require an assist to get across membranes efficiently. We now know that most water, just like most solutes, crosses membranes by facilitated diffusion.

As you may imagine, the molecular movement into or out of cells is further controlled by allosteric regulation of these proteins. Shortly, we'll consider water transport as a special case of facilitated diffusion of a solvent rather than solutes. First, let's look at passive diffusion.

A. Passive Diffusion

Passive diffusion is the movement of molecules over time by random motion from regions of higher concentration to regions of lower concentration. Diffusion of solutes in a solution is illustrated in this link: <http://youtu.be/1PPz5kzOChg>. Significant passive diffusion across cellular membranes is limited to a few molecules, like gasses (O₂, CO₂, N₂...) that can freely cross the hydrophobic phospholipid barrier. The rapid diffusion of these gasses is essential during physiological respiration when O₂ and CO₂ exchange between the alveolar capillaries and cells of the lungs, and during cellular respiration in mitochondria. Diffusion across membranes does not require energy. In fact, diffusion across membranes releases energy - recall the movement of protons through the F1 ATPase proton gate linked to ATP synthesis during oxidative phosphorylation. As suggested in the animation, the diffusion of a molecule is determined by its own concentration; it is unaffected by the concentration of other molecules. Over time, random motion of solutes within and across compartments results in a *dynamic* equilibrium for each different solute over time. At equilibrium, solute molecules continue to diffuse across the membrane but for each molecule moving across in one direction, another molecule of the same solute crosses in the other direction.

B. Facilitated Diffusion of Solutes and Ions

Facilitated diffusion is the spontaneous (downhill) passage of molecules or ions across a biological membrane passing through specific *transmembrane proteins*. The difference between passive and facilitated diffusion is easily seen in the kinetics of each. Recall that the rate of enzyme catalysis is *saturable*. That is, as the concentration of substrate is increased, the rate of the catalyzed reaction approaches a maximum (V_{max}), when all enzyme molecules in solution are bound to substrate molecules. The same saturation phenomenon applies to facilitated transport – the rate of solute movement across a membrane is directly proportional to the number of transport proteins in the membrane. The kinetics of passive and facilitated diffusion can be measured and graphed as shown below.

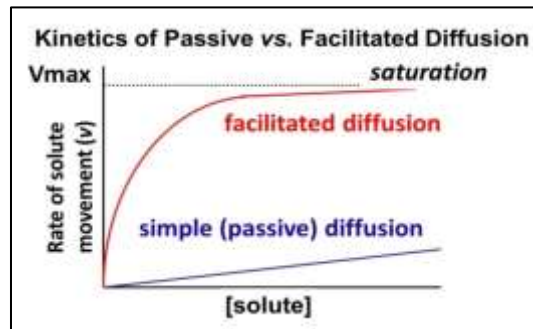

There are three kinds of *facilitated transport* of solutes (below).

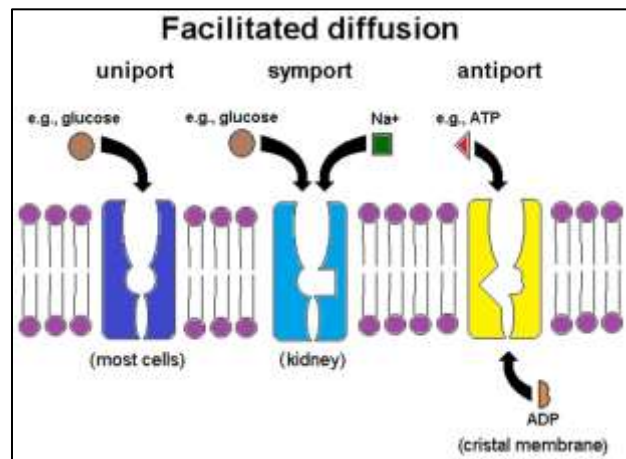

The GLUT protein (glucose transporter) protein illustrated above (left) allows glucose *uniport*, the specific transport of a single substance in or out of cells. Other glucose transport proteins couple the simultaneous movement of glucose and sodium ions into cells, an example of *symport* (above center). Molecules can also be exchanged across membranes by *antiport* (above right). In this example, ATP crosses the cristal membrane out of the mitochondrial matrix at the same time as ADP enters the matrix.

Whether by uniport, symport or antiport, solutes independently cross membranes from regions where each is at high concentration to cellular compartments where each is at lower concentration. Recall that diffusion proceeds with a release of free energy, the amount being dependent on the concentrations of the solutes. The difference between uniport of glucose and symport of glucose and sodium ions is animated at <http://youtu.be/OEFUvF56deU>.

Proteins mediating facilitated diffusion include **carrier proteins** and **channel proteins**. Carrier proteins allow solute transport while channel proteins are essentially ion pores; with their high charge-to-mass ratio, ions cannot freely cross the hydrophobic membrane barrier. Both carrier and channel proteins undergo allosteric change during transport. They are also typically subject to allosteric regulation, rather than being in a constant 'open' state. Click <http://youtu.be/SXL1RBK3Rm8> to compare passive and facilitated diffusion. Examples of facilitated diffusion are considered in further detail below.

1. Carrier Proteins

Carrier proteins undergo allosteric change when they bind to a solute to be transported. As the solute is transported, the carrier protein undergoes a second conformational change, so that when the solute reaches the other side of the membrane, it no longer has a high affinity for the carrier protein. Upon release of the solute after transport, a final allosteric change restores the shape of the transport protein (below).

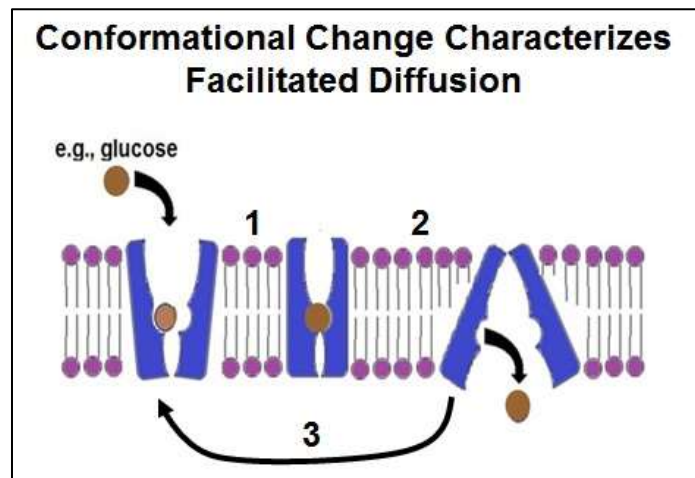

Any given carrier protein is specific for a single solute, or at most a single family of closely related solutes. We just saw the GLUT1 transporter carrier protein that allows glucose (but not fructose or ribose!) to cross cell membranes. Specific carrier proteins also facilitate the transport of amino acids and other charged solutes across cell membranes. Once again, carrier proteins can be allosterically regulated by molecules

inside or outside of cells that are indicators of cell status, i.e., their need to take up or release a particular solute. A perfect example is the regulation of glucose transport into cells by insulin. One of the consequences of insulin released during a meal (or even just in anticipation of a meal) stimulates glucose transporters to take up glucose. Type II (adult onset) diabetes is in part caused by an inability of those transporters to respond to insulin.

Now for that special case! Most water gets across membranes by facilitated diffusion using **aquaporins**. Small amount of water can cross the phospholipid bilayer unassisted or incidentally when ions flow through their channel proteins. But aquaporins are required to facilitate diffusion of water across membranes at high rates. Some aquaporins only transport water. Others have evolved to co-facilitate the transport of glucose (see above), glycerol, urea, ammonia and carbon dioxide and even ions (protons) along with water. Like other carrier proteins, aquaporins are allosterically regulated to allow cells to meet their specific water balance requirements. So fundamental was the understanding of water balance that the discovery of aquaporins earned Peter Agre a Nobel Prize in Chemistry in 2003.

Since Agre's discovery (in 1992), several genetic diseases have been linked to mutations in aquaporin genes. One is a rare form of diabetes in which the kidneys excrete abnormally large volumes of water; kidney cells are critically involved in vertebrate water balance and contain large amounts of aquaporins in their membranes. Another example involves mutations in aquaporin genes that lead to the development of cataracts in both eyes. Since their initial discovery in red blood cells in 1992, aquaporins have been found in bacteria and plants. See more about aquaporin research at <http://en.wikipedia.org/wiki/Aquaporin>. Learn more about the osmosis shortly.

2. Ion Channels

Ion homeostasis in blood and extracellular fluids is tightly controlled, often within very narrow limits, by allosteric regulation of ion channel proteins. Ion channels are often formed from more than one integral membrane protein. When stimulated, channel proteins rearrange to open a polar pore to allow specific ion transport. Some ion channels (like the glucose/sodium ion symport system noted above) mobilize the energy of diffusion to co-transport an ion with another solute through a carrier protein. Ion channels are also responsible for the excitability of cells, where Na^+ , K^+ and Ca^{++} channels collaborate in ion movements into and out of cells leading to neuronal or muscle cell responses (more shortly!).

C. Osmosis

In experiments, water can be shown experimentally to cross permeable artificial membranes (such as those of a dialysis bag you might have used in a lab experiment) by passive diffusion. But as just noted, water is highly polar and only crosses the hydrophobic phospholipid barrier of cellular membranes very slowly. Instead, rapid water movement required by cellular metabolism is through **aquaporin**. Water will cross a membrane if the net solute concentration is higher on the other side, in an “attempt” to equalize the solute concentrations on either side of the membrane. In effect, the water movement is from the side of a membrane where the *free water* molecule concentration is higher (i.e., where the solute concentration is lower) to the side where the free water concentration is lower (i.e., where the solute concentration is higher).

CHALLENGE: What do you think is meant by the term “free water” here?

The diffusion of water across membranes from low to high solute concentrations is called **osmosis**. Osmosis is an essential activity. It allows cells to use water to maintain cellular integrity or to adapt to changes in the solute composition of the extracellular environment.

1. The effects of Osmosis on Animal and Plant Cells

Consider the effect of different experimental solute concentrations on animal cells, illustrated below.

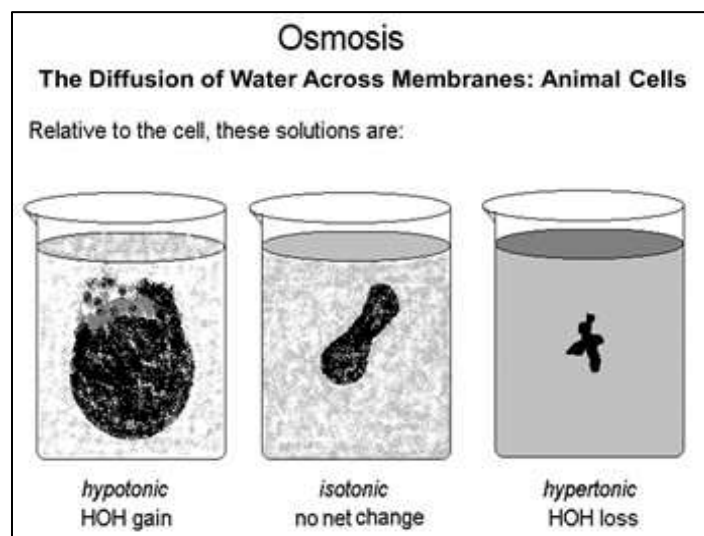

If the solute concentration inside and outside the cell is the same, there will be no net movement into or out of the cells. The extracellular solution and cytosol are said to be **isotonic** to each other, with the same net solute concentration. If the cells are placed in a low solute medium, water diffuses into the cells in an effort to lower the cytosol solute concentration. The medium is said to be **hypotonic** to (less concentrated than) the cytosol. Under hypotonic conditions animal cells will swell and burst. If the cells are placed in a **hypertonic** solution (one with a higher solute concentration than the cytosol) water leaves the cell and the cells shrivel up. From this brief description you can conclude that water crosses from the hypotonic to the hypertonic side of a membrane.

Exposure of plant cells to hypotonic or hypertonic solutions has similar effects on water movement across cell membranes. However, cell walls limit how much a plant cell can swell, and shriveling looks different because the cell membrane is actually attached to the cell wall! Thus, water entering plant cells in hypotonic media moves from the cytosol into water vacuoles called **tonoplasts**. This results in higher **osmotic pressure** (water pressure) in the tonoplasts, and therefore in the cytosol, thus pushing against the cell membrane. Rather than bursting, the cell membrane pushes against cell walls causing the cells and plant tissues to stiffen, or become **turgid**. The pressure against plant cell walls is called **turgor pressure**. You will have encountered this phenomenon if you ever over-watered house plants; the stiffened leaves and stems become brittle and are easily snapped or broken. As you might guess, water cannot enter plant cells indefinitely, even in hypotonic solutions. Instead, water stops entering the cells when the **osmotic pressure** outside the cells and the turgor pressure inside the cells are at equilibrium. The effects of hypertonic and hypotonic solutions on plant cells are illustrated below.

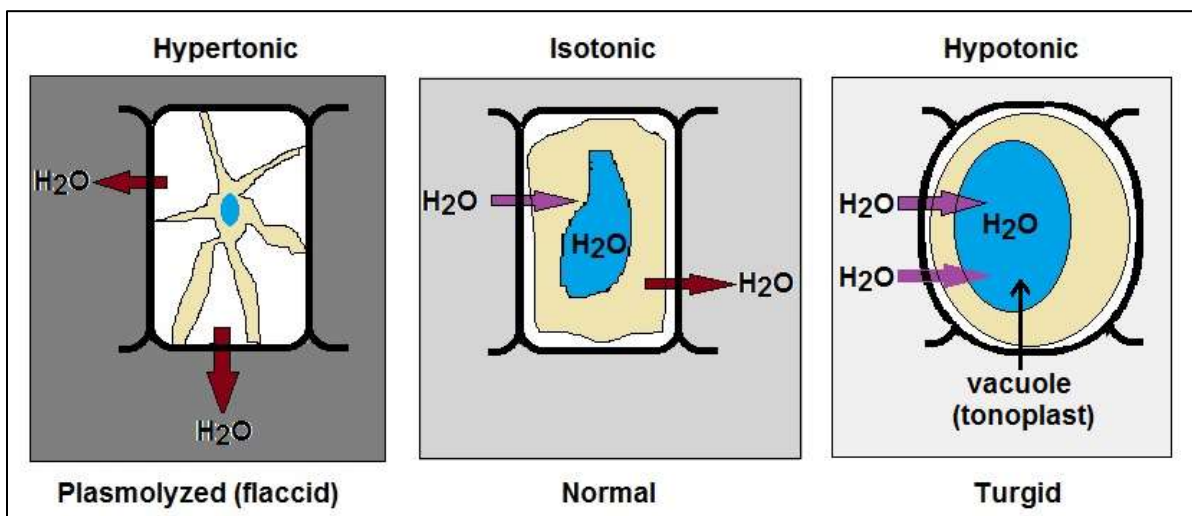

Plant cell membranes are actually attached to the cell wall at **plasmodesmata**, structures that connect the plasma membranes of adjacent cells through their cell walls, allowing them to directly share chemical information. So, when plant cells lose water in a hypertonic solution, they undergo **plasmolysis**, membrane shrinkage while maintaining cell wall attachments. You may have seen under-watered plants with floppy or droopy stems and leaves. These have become **flaccid** because the turgor pressure is insufficient to keep the leaves and stems upright.

Normally, plant cells require a continual supply of water for use in photosynthesis (to provide hydrogen to reduce CO₂ to glucose) and because excess water is lost from plant tissues (especially leaves) by transpiration. The use and loss of water lowers cellular osmotic pressure. As water moves up from the roots to replace water used and lost by leaf cells, the osmotic pressure drops in the *fine root hair cells* (with their high surface area). This draws water into the cells and roots by osmosis. Thus osmotic pressure is the main force driving water into plants and, defying gravity, up from the roots to the rest of the plant.

Formally, osmotic or turgor pressure is defined as the force per unit area (pressure) required to prevent the passage of water across a semipermeable membrane from a hypotonic to a hypertonic solution.

2. Osmotic Pressure and Osmoregulation

Changes in osmotic environment can stress or kill an organism. For example, freshwater organisms (protozoa or fish) placed in sea water will die. Likewise salt-water fish placed in freshwater. However, organisms can **osmoregulate**, or control the osmotic pressure in their cells, at least to a point. Take **Paramecium** for example. Water constantly enters these freshwater protists because the solute concentration in the cytosol is always higher than the freshwater water they live in. To cope with a constant uptake of water, the cells contain **contractile vacuoles** that collect excess water and then contract to expel the water.



At a high energy cost, *Paramecia* constantly pump water out of the cell to maintain water balance (i.e., correct osmotic pressure). Larger organisms like freshwater fish cope with their hypotonic environment by urinating a lot!

At the other end of the spectrum, salt-water fish cope with the high solute concentration of solutes (salts) in their environment by excreting excess salt. And then there are salmon which spend time in seawater growing to maturity and later swim upstream in fresh water to spawn. You can imagine how salmon and similar organisms have to osmoregulate to adapt to their very different environments. In this case, *osmo-adaptation* begins when hormonal changes respond to changes in living circumstance and dictate a compensatory response.

Summing up, osmosis is the movement of water across membranes to where solutes are at high concentration. At the same time, solutes that can diffuse across membranes move in or out of cells towards where they are at lower concentration. Water crosses membranes by facilitated diffusion through aquaporin proteins that serve as pores in cellular membranes. We have evolved different facilitated transport proteins specific for different proteins.

D. Active Transport

Excitability (adaptation) is another of the defining properties of life. This property of all cells is based on chemical and electrical reactivity. When neurotransmitters are released at a neuron, they cross the synaptic cleft and bind to receptors on the responding cell (another neuron, a muscle cell). The result is a **membrane depolarization** (a rapid change in the electrical potential difference across the cell membrane of the responding cell); responses to neurotransmitters occur in fractions of a second. The changes in membrane polarity depend on *unequal* concentrations of ions inside and outside cells. Cells at rest typically have a higher **[K⁺]** in the cytosol and higher **[Cl⁻]** and **[Na⁺]** outside the cell (below).

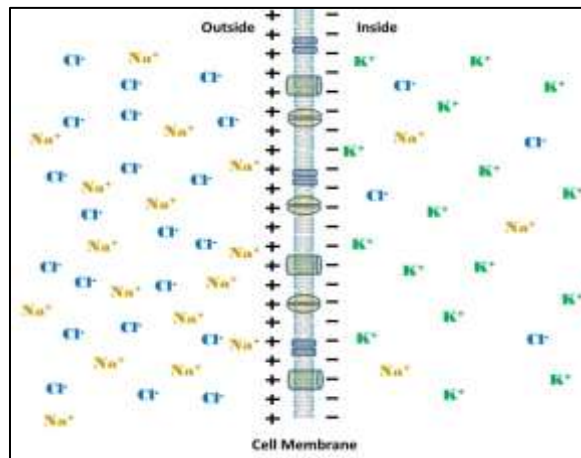

Thus cells have a **resting potential**, typically about -50mv to -70mv, shown here as a difference in charge or **potential difference** across the membrane. Membrane depolarization in responsive cells (neuron, muscle) results in a flow of ions, as does the e.g., the ion-assisted symport of glucose already noted. And, while not subject to ion flow mediating a specific cellular function, the ion gradients sustaining a cellular resting potential are slowly disturbed by a slow leakage across membranes otherwise impermeable to ions. Whether by a dramatic depolarization or other utilitarian ion flow or just ion leakage, cells must expend energy to restore cellular ion concentrations. The maintenance of a correct balance of ions requires the **active transport** of these ions across the membrane. This energetically unfavorable process requires an input of free energy. ATP hydrolysis provides the energy for operation of a **Na⁺/K⁺ pump**, an active transport protein complex linked to **ATPase** activity. Jens C. Skou discovered the Na⁺/K⁺ pump in 1950 and received a Nobel Prize in 1997 in recognition of the importance of our understanding of ion movements across cell membranes. We will consider ion flow during cell excitation and at how ion pumps work. Let's begin by looking at how a Na⁺/K⁺ pump works to restore and maintain ion gradients.

Refer to the animation at this link as you read: <http://youtu.be/-xZvya2Gt50>. From the video at this link you see that as ATP is hydrolyzed by the ATPase domain of the Na⁺/K⁺ pump, the hydrolyzed phosphate attaches to the pump. This results in an allosteric change allowing the pump to bind 3 Na⁺ ions. Binding of the Na⁺ ions causes a second conformational change causing release of the Na⁺ ions into the extracellular fluid. In this new conformation, two K⁺ ions from the extracellular fluid bind to the pump protein. K⁺ binding causes the hydrolysis of the phosphate from the pump protein, along with a final allosteric change allowing the release of the two K⁺ ions into the cytosol. Returned to its starting shape, the Na⁺/K⁺ pump is ready for action again.

III. Ligand and Voltage Gated Channels at Work in Neurotransmission.

A. Measuring Ion Flow and Membrane Potential

When a neurotransmitter binds to receptors on a responding cell (e.g., another neuron, a muscle cell), **ligand-gated ion channels** open, allowing an influx of Na⁺ ions, thereby disrupting the resting potential of the target cell. The effect is only transient if the membrane potential remains negative. But if enough Na⁺ ions enter the cell, the membrane is depolarized and can become **hyperpolarized**, causing a localized *reversal of normal membrane polarity* (say from -70 mV to +65mV or more). Hyperpolarization generates an **action potential** that will travel like a current along the neural or muscle cell membrane, eventually triggering a physiological response, e.g., the excitation of the next nerve cell in a neuronal pathway or contraction of the muscle cell.

Ion flow across a cell membrane can be detected using the **patch-clamp** technique, illustrated below:

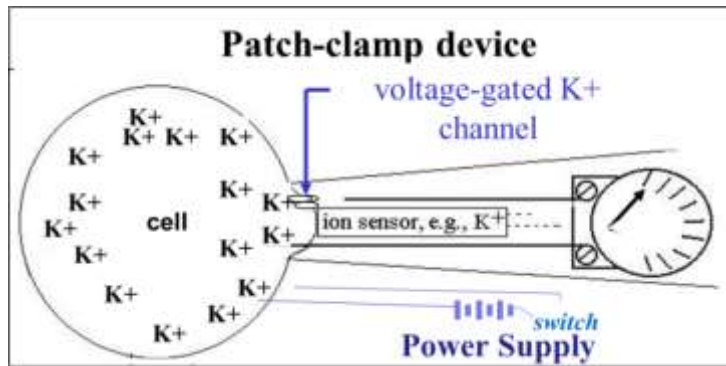

The patch-clamp technique reveals a correlation between ion movements during the generation of an action potential, as illustrated below.

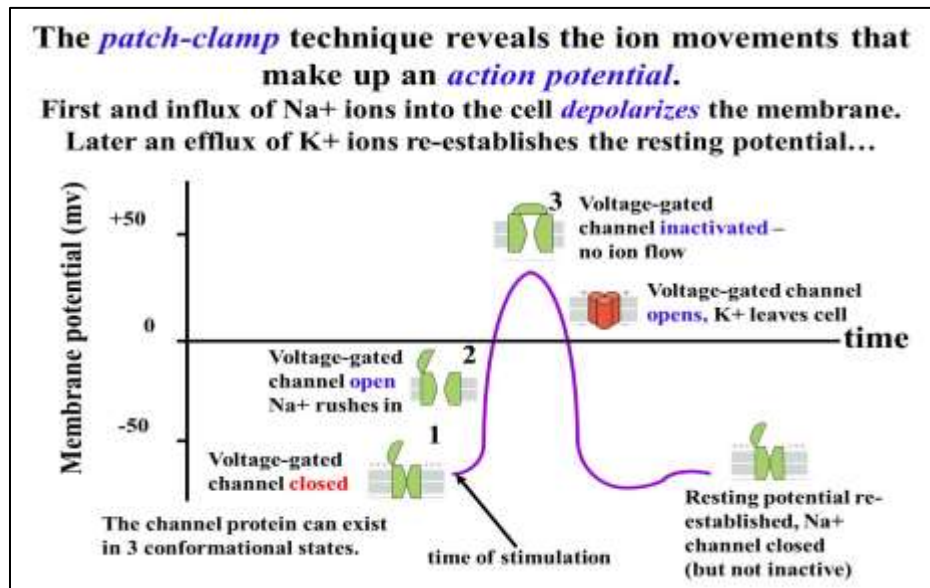

An action potential (in fact any degree of shift from resting potential) involves facilitated diffusion of specific ions into or out of the cell through specific gated ion channels that must open and close in sequence. You can see from this illustration that active transport will not be necessary for restoring the resting potential, at least not directly. The cell can continue to respond to stimuli with action potentials... for as long as there is sufficient Na⁺ outside the cell and K⁺ inside the cell.

The ATP-dependent Na⁺/K⁺ pump *does* participate indirectly to restore the *resting* potential across membranes by restoring the appropriate Na⁺-K⁺ balance across the responding cell membrane. After a nerve or muscle cell *fires* once or several times, the

[K⁺] inside the cell and the [Na⁺] outside the cell would drop to a point where the cell can't fire again... were it not for the operation of Na⁺/K⁺ pumps. Each cycle of pumping exchanges 3 Na⁺ ions from the intracellular space for 2 K⁺ ions from the extracellular space. The pump has three effects:

- It restores sodium concentrations in the extracellular space relative to the cytoplasm.
- It restores potassium concentrations in the cytoplasm relative to the extracellular space.
- Together with the higher Cl⁻ ion concentration in the cytosol, the unequal exchange of Na⁺ for K⁺ ions maintains the resting potential of the cell.

B. Ion Channels in Neurotransmission

The initial membrane depolarization phase of an action potential results from an orderly, sequential response of *voltage-gated* and *ligand-gated* channels in the signaling neuron. Click <http://youtu.be/BLvXloKh8ul> to see how the sequential cycling of voltage-gated channels propagates a localized action potential (membrane depolarization) along an axon towards a synapse. In a responding muscle cell, membrane ion channels will either open upon electrical stimulation or by binding of a chemical ligand (the neurotransmitter). The cooperation of different gated channels at a neuromuscular junction is illustrated below:

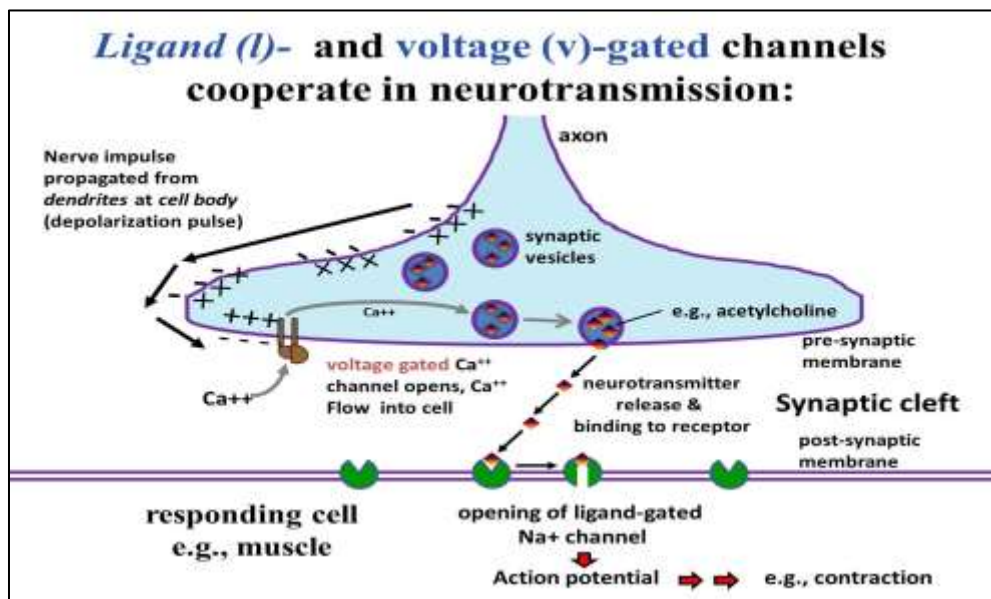

See this process animated at this link: <http://youtu.be/tSks9WPDxHM>

As you can see from the illustration, two kinds of channels are at work here, **ligand-gated channels** and **voltage-gated channels**. After a neuron fires, an electrical impulse (a moving region of hyperpolarization) travels down the axon to the nerve ending, where this transient charge difference across the cell membrane (an electrical potential) stimulates a Ca^{++} -specific **voltage-gated channel** to open. Ca^{++} ions then flow into the cell because they are at higher concentrations in the synaptic cleft than in the cytoplasm. The Ca^{++} ions cause release of neurotransmitters into the synaptic cleft. The neurotransmitters bind to a receptor on the responding cell plasma membrane. This receptor is a **ligand-gated channel** (also called a **chemically-gated channel**). Upon binding of the ligand (neurotransmitter) the channel protein opens, allowing rapid diffusion of Na^+ ions into the cell, creating the action potential that leads to the cellular response, in this case, muscle contraction. We have already seen that K^+ channels participate in restoring membrane potential after an action potential. We'll look later at the cellular events, including more ion flux and pumping involved in contraction.

CHALLENGE: Many spider, snake and other neurotoxic venoms work by interfering with ion channel function to paralyze or otherwise immobilize prey organisms. Which of the channels mentioned here would you expect to be affected by neurotoxic venoms, or for that matter, neurotoxic gasses? Can you explain your answer?

IV. Endocytosis and Exocytosis

Endocytosis is a mechanism for internalizing extracellular substances, usually large molecules like proteins, or insoluble particles or microorganisms. The three main types of exocytosis are phagocytosis, pinocytosis and receptor-mediated endocytosis. Pinocytosis is non-specific. Phagocytosis targets large structures (e.g., bacteria, food particles...). As its name suggests, receptor-mediated endocytosis is specific for substances recognized by a cell-surface receptor.

Exocytosis is typically the secretion of large molecules. These could be proteins and glycoproteins like digestive enzymes and many peptide/polypeptide hormones, each of which must exit the cell to either the extracellular fluid or circulation. Exocytotic pathways also deliver membrane proteins made in cells to the cell surface.

A. Endocytosis

The three main kinds of endocytosis are summarized below.

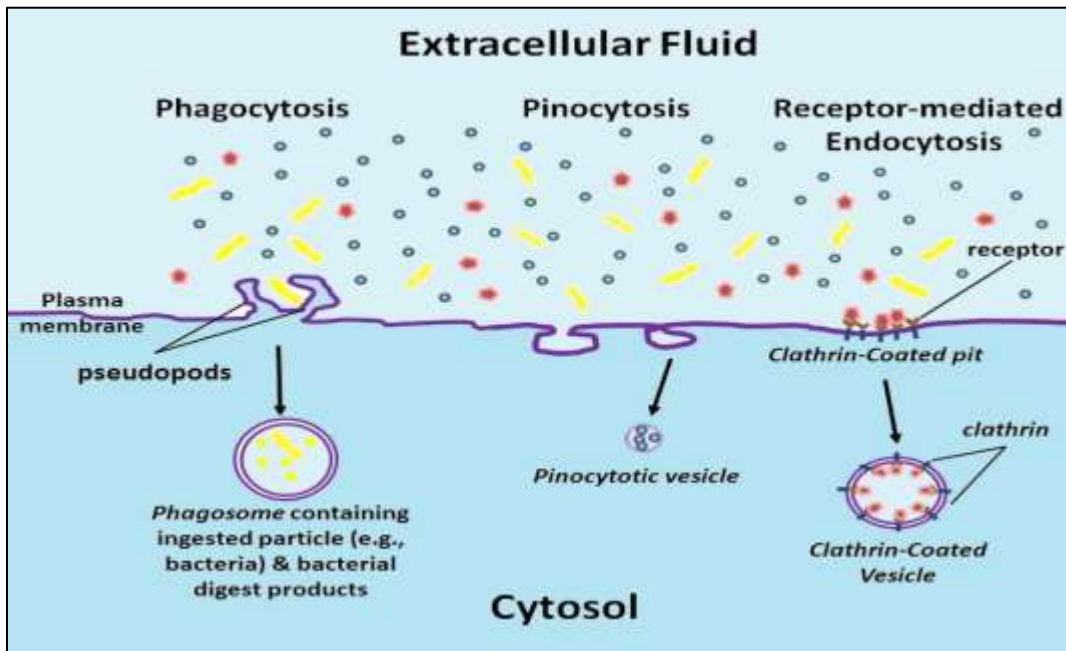

1. **Phagocytosis** (above left): **Phagocytes** extend *pseudopodia* by membrane **evagination**. The pseudopodia of amoeba (and amoeboid cells generally) engulf particles of food that end up in digestive vesicles (**phagosomes**) inside the cytosol. Phagocytes, a class of white blood cells that are part of our immune system, engulf foreign particles that must be eliminated from the body. Engulfed particles are digested when a *lysosome* fuses with the phagosome, activating stored hydrolytic enzymes. Phagocytosis is initiated when particles are detected at the outer cell surface.
2. **Pinocytosis** (above center): Pinocytosis is a non-specific, more or less constant pinching off of small vesicles that engulfs extracellular fluid containing solutes; they are too small to include significant particulates.
3. **Receptor-mediated endocytosis** (above right): Receptor-mediated endocytosis relies on the affinity of **receptors** for specific extracellular substances that must be internalized by the cell. Upon binding their ligands, the receptors aggregate in differentiated regions of cell membrane called **coated pits**. The coated pits then invaginate and pinch off to form a **coated vesicle**. The contents of the coated vesicle are eventually delivered to their cellular destinations, after which their membranes are recycled to the plasma membrane.

As receptor-mediated endocytosis is perhaps the best understood mechanism for bringing larger substances into cells, let's take a closer look. The electron micrograph series below illustrates the invagination of coated pits to form *clathrin-coated vesicles*; the receptor and coat proteins are clearly visible as large particles!

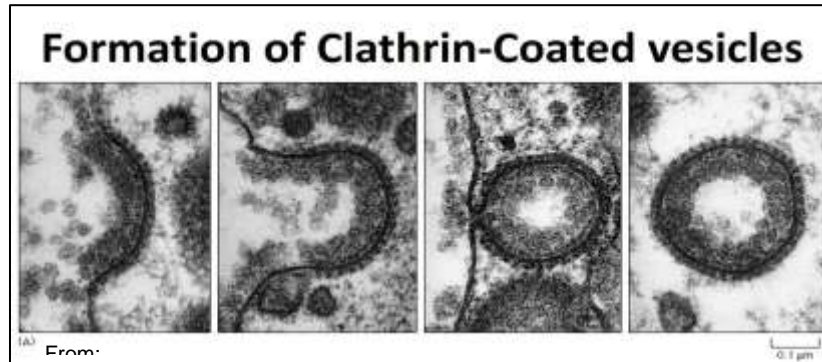

Clathrin, a large protein, is linked to specific integral membrane proteins via **adaptor protein 1 (AP1)**. While clathrin is the principal protein on the surface of the invaginated coated pit, **AP1** recruits specific *cargo proteins* to be brought into the cell when the coated pits invaginate. Some details of receptor-mediated endocytosis is illustrated below.

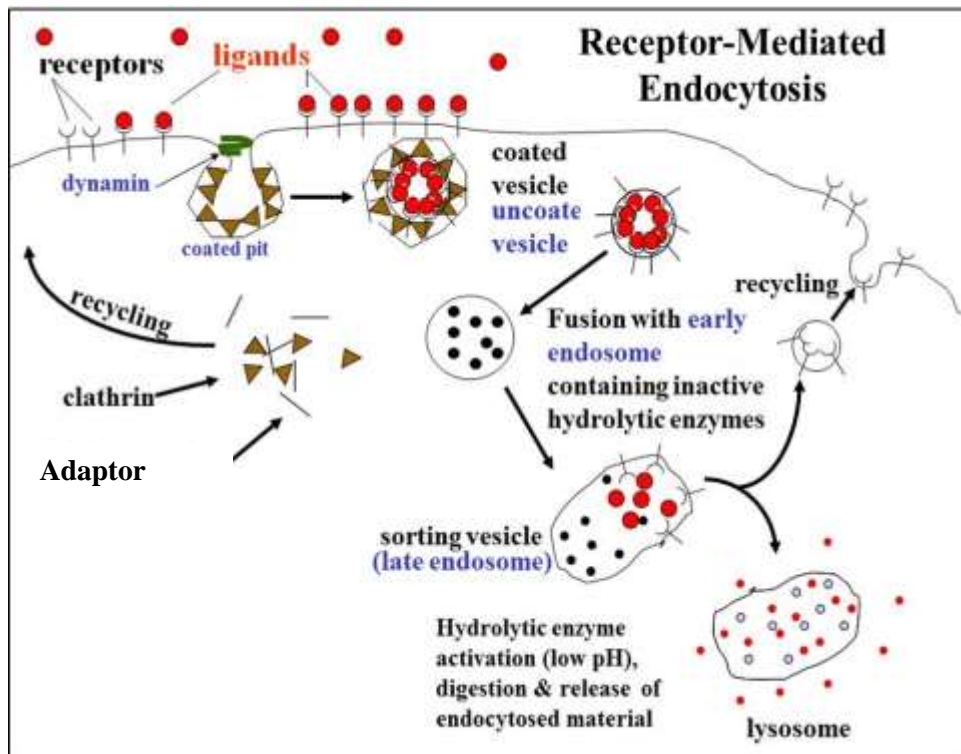

As the illustration shows, substances to be internalized bind to receptors on the cell membrane that then cluster to form a **coated pit**. Assisted by the protein **dynamin** (a GTPase), the coated pits invaginate. The final pinching off of a **coated vesicle** required GTP hydrolysis.

Once internalized, the coated vesicles lose their clathrin and associated adaptor protein coat. The uncoated vesicle fuses with an **early endosome** to form a **sorting vesicle** that separates imported content from the receptors that are recycled to the membrane. In the vesicle that remains, now called a **lysosome**, digestive enzymes catalyze hydrolysis of the vesicle contents which are released for cellular use.

A major example of receptor-mediated endocytosis is the uptake of cholesterol bound to *low density lipoprotein* (**LDL**), a complex of phospholipid, protein and cholesterol illustrated below.

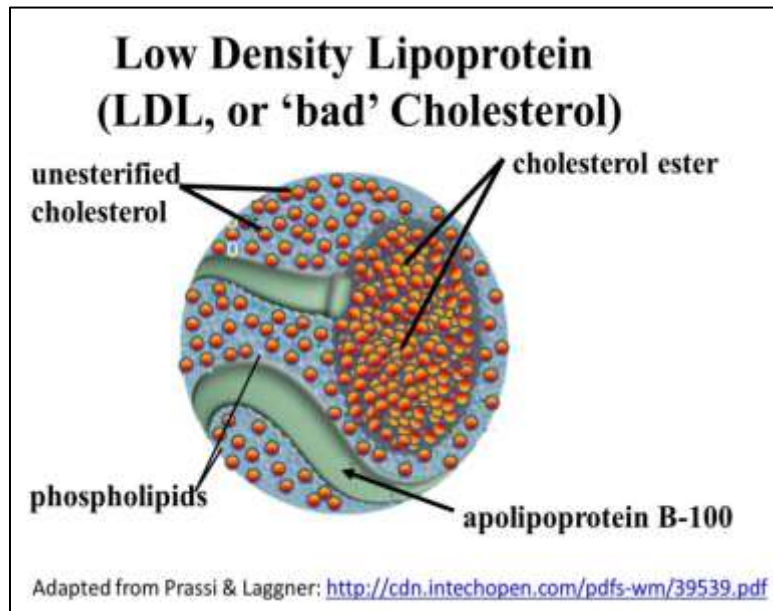

As many as 15,000 molecules of cholesterol can be carried by a single LDL complex. LDL is sometimes called “bad cholesterol” because it is not good for you when it is too high, compared to high-density lipoprotein (HDL), often called “good cholesterol”.

B. Exocytosis

Maintaining cell size or volume seems to be a built-in component of the machinery of receptor-mediated endocytosis. However, exocytosis is necessary to restore plasma membrane internalized by pinocytosis and phagocytosis, and for eliminating cellular

waste products. Exocytosis is also the end-point of a complex process of packaging proteins destined to be secreted from the cell or to be membrane proteins themselves.

Below is a more detailed summary pathways *shared* by exocytosis and endocytosis, including the formation of lysosomes, secretion vesicles and similar organelles, along with the fate of endocytosed particles whose molecular components will be digested and used by the cell.

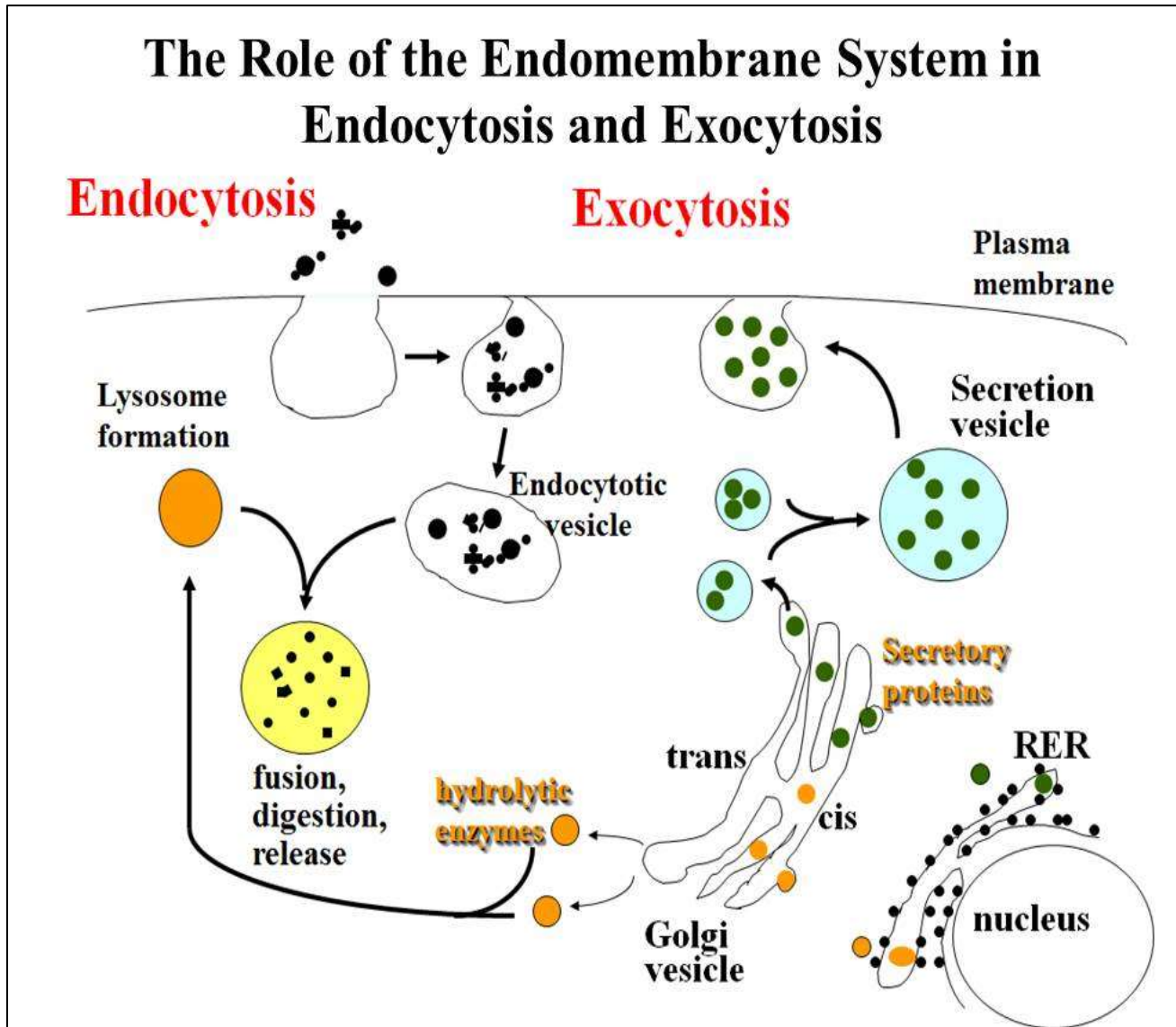

Some representative proteins packaged for secretion or sent to plasma membrane extracellular surfaces by exocytosis are listed in the table below.

Some Proteins Packaged and Transported Through the Endomembrane System

Hormones	Immune System Proteins	Neurotransmitters	Other
insulin	IgG (immunoglobulin G, a class of circulating antibodies)	acetylcholine	EGF (Epidermal growth factor)
growth hormone	IgM and other cell membrane antibodies		NGF (Neural growth factor)
FSH (follicle stimulating hormone)	MHC (major histocompatibility complex) proteins on cell surfaces	dopamine, adrenaline noradrenaline & other monoamines	Fibrinogen (& other blood clotting factors)
oxytocin		serotonin	Fibronectin (and other extracellular matrix proteins)
prolactin		some amino acids (glutamate, aspartate, glycine)	Plant cell wall components
ACTH (adrenocorticotropic hormone)			Trypsin, pepsin, et al. (digestive enzymes of the gut)

Many secretory and membrane proteins are glycoproteins, to which sugars are attached starting in the rough endoplasmic reticulum (see above). Individual cells often produce more than a few packaged proteins at the same time, requiring the sorting of each protein to its correct destination – extracellular fluids, lysosomes, peroxisomes, other ‘microbodies’ containing hydrolytic enzymes remain and of course, the plasma or other membranes. Next we consider how cells target their proteins to different intracellular and extracellular destinations.

V. Directing the Traffic of Proteins in Cells

All proteins are translated on ribosomes that read the base sequence on mRNA and catalyze peptide bond formation leading to the appropriate amino acid sequence (the primary structure) of polypeptides. Each protein has a specific functional location, either in the cytoplasm, on cellular membranes, inside organelles or in extracellular fluids. In this section we consider the movement and sorting of proteins in the endomembrane system as well as the transport of proteins into and out of organelles.

A. Packaging proteins in the RER

All proteins begin synthesis in the same way, with the formation of an initiation complex and subsequent elongation cycles of carboxyl terminal growth by amino acid addition. But secretory proteins and proteins destined for lysosomes, peroxisomes or other microbodies complete elongation directly into the RER cisternae.

An early experiment showed that secreted polypeptides made in an *in vitro* translation system were larger (longer) than the same polypeptides isolated from secretion fluids. In this experiment, mRNA was isolated from a mouse *myeloma* (cancer) cell line that synthesized an easily identified immunoprotein, the *IgG light chain*. The cells were allowed to grow in media containing radioactive amino acid precursors so that they would secrete radioactive IgG light chain. mRNA was extracted from another batch of myeloma cells and mixed with a cell-free translation system also containing radioactive amino acids. The proteins made *in vivo* and those translated *in vitro* were compared side by side on electrophoretic gels that separate proteins by molecular weight (effectively equivalent to polypeptide length). As detected by autoradiography after electrophoresis, the radioactive polypeptide synthesized *in vitro* migrated more slowly on the gel than the mature, secreted polypeptide, meaning that the cell-free translation product was larger than the *mature* secreted polypeptide. This experiment is summarized below.

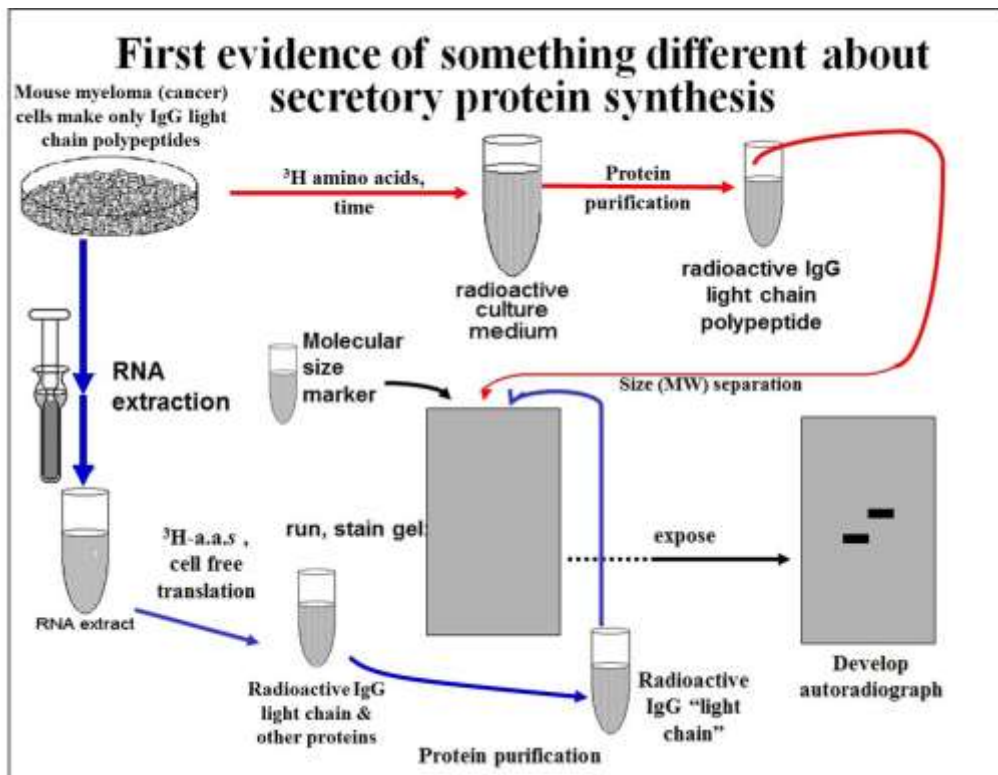

These results suggested the hypothesis that the extra amino acids in the cell-free translation product are a signal that directs a growing secretory polypeptide to the RER. In other words, the signal to interact with the RER was a sequence already encoded in the gene, an hypothesis tested by Gunther Blobel and colleagues.

What became known as the **Signal Hypothesis** proposed that polypeptides destined to be packaged in the RER were synthesized with a short amino-terminal sequence. Serving as a temporary ‘traffic’ signal, this sequence would be removed by an RER-associated enzyme as the polypeptide crossed the RER membrane. The test of the Signal Hypothesis (which won Blobel a Nobel Prize in 1999) was to include isolated RER membranes along with the secretory protein mRNA in the cell-free protein synthesis system. This time, electrophoresis showed that the proteins made *in vitro* in the presence of RER were the same size as the mature, secreted polypeptides – the RER must therefore have a traffic signal removal (processing) activity.

The follow-up hypotheses, that the signal peptide recognizes and binds to RER and that the RER contains a signal peptidase that removes the signal peptide were tested. The *Signal Hypothesis*, as confirmed, is illustrated below.

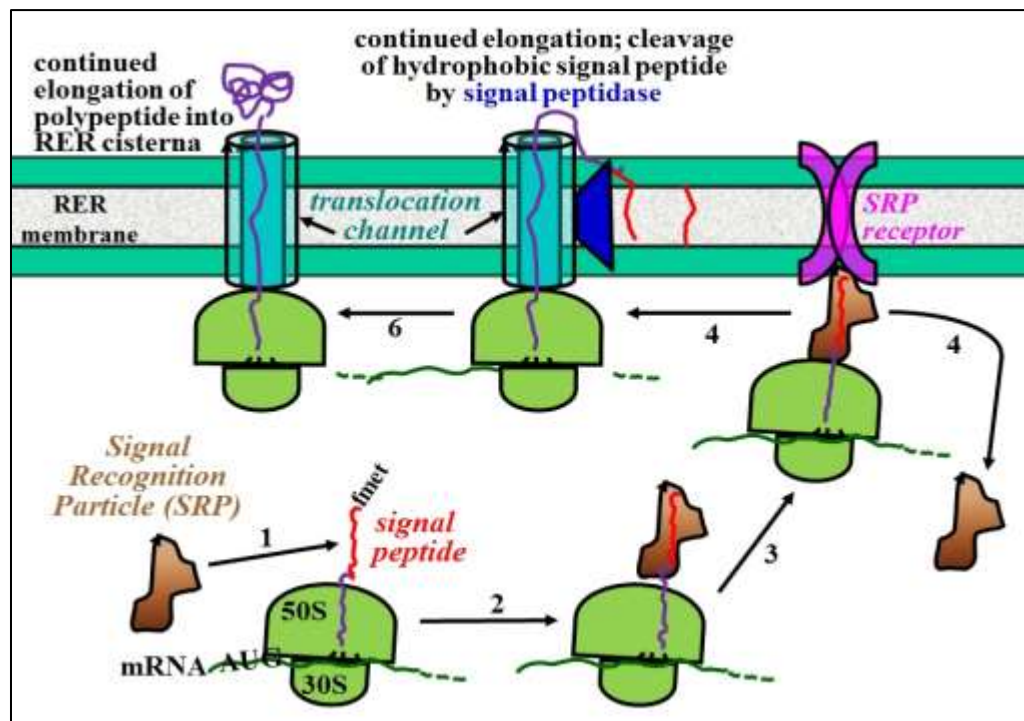

After a ribosome (green) assembles on an mRNA for a protein targeted to the RER, translation is initiated. During elongation the growing polypeptide emerges from a channel in the large subunit and can interact with the RER membrane.

From the illustration above, the steps of the process are:

1. Elongation results in the extension of a **signal sequence (signal peptide)** beyond the confines of the large ribosomal subunit. The signal peptide is a mostly hydrophobic region at the N-terminus of the growing chain.
2. An **SRP (signal recognition particle)** binds to the amino-terminal hydrophobic *signal peptide*.
3. Translation is then *arrested* until the SRP-ribosome complex finds the RER membrane.
4. The ribosome-SRP complex binds **SRP receptor** on the RER membrane and the SRP detaches from the growing polypeptide chain. The SRP is recycled).
5. Translation elongation resumes through a **translocation channel**.
6. A **signal peptidase** enzyme in the RER membrane recognizes and catalyzes **co-translational** hydrolysis of the signal peptide, which remains embedded in the RER membrane.
7. Elongation continues; the growing polypeptide begins to fold in the RER.

The secretory mechanism just described for eukaryotes has its counterpart in bacteria, which engage in protein secretion to assist in nutrient scavenging as well as to produce their cell walls. Ribosomes bound to the inner surface of bacterial cell membranes pass proteins being synthesized out of the cell into the space between the cell membrane and wall. As the protein exits the cell, a signal sequence is cleaved by a bacterial signal peptidase (*SPase*). Apparently the mechanism for the secretion of proteins has been conserved... and coopted by eukaryotes for packaging proteins in organelles emerging from the endomembrane system.

Early on, we discovered that some antibacterial antibiotics stop bacterial growth either by disrupting the cell wall itself (e.g., *penicillins*), or by disrupting *SPase* function (e.g., *arylomycins*). The latter prevent proteins required in the space between the cell wall and membrane from ever making it out of the cell. These antibiotics, were once effective against *Staphylococcus aurease*. But many strains have become resistant to these antibiotics (click [Bacterial Signal peptidase and Antibiotic Resistance](#) to read about the mechanism of *arylomycin* resistance). As you may already know, *S. aurease* is now resistant to many antibiotics, and illness from untreatable infections has its own name, **MRSA** (Methicillin-Resistant Staph Aurease - dig on your own to see more about methicillin resistance). While named for *methicillin* resistance, MRSA now describes *nearly* untreatable *S. aurease* infections.

B. Synthesis of Membrane-Spanning (Integral) Proteins

N-terminal signal sequences also guide integral proteins to the RER. But a **stop-transfer** sequence (hydrophobic domain within the polypeptide chain) traps the protein in the fatty acid interior of the membrane. Multiple stop-transfer sequences result in transmembrane proteins that span a membrane more than once (below)

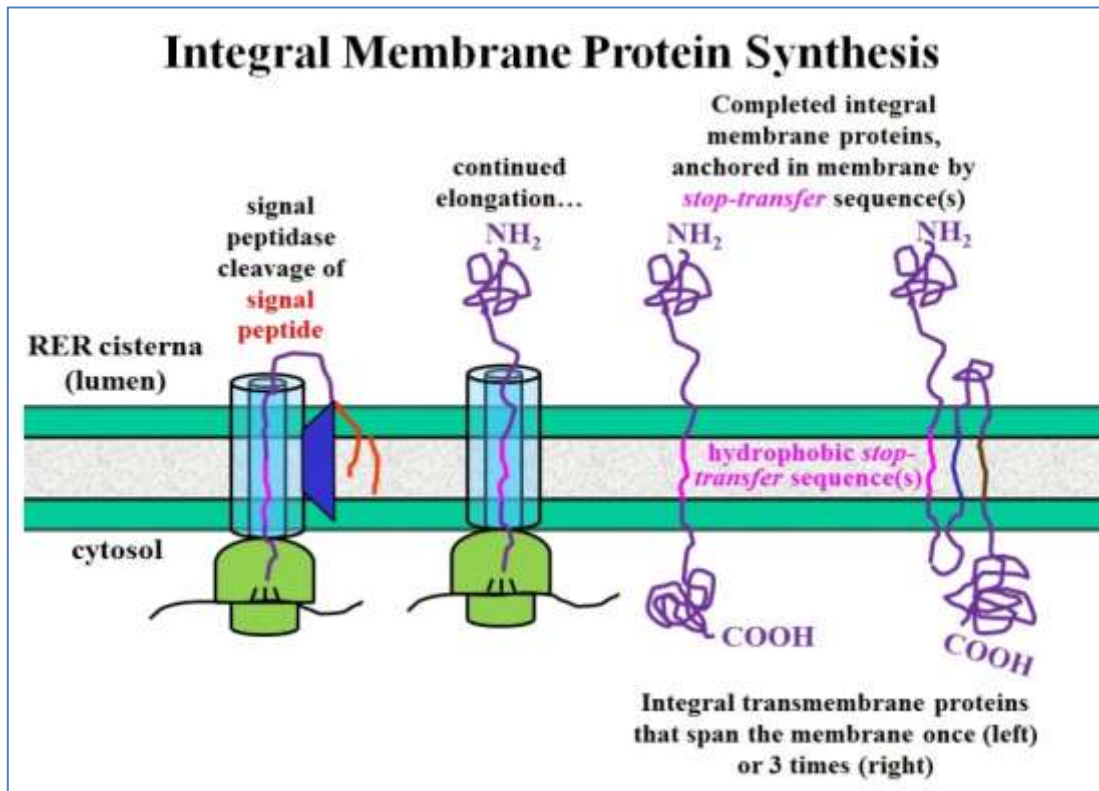

C. Moving and Sorting Packaged Proteins to Their Final Destinations

1. Traffic on the Endomembrane Highway

Once packaged proteins are in the RER cisternae they start post-translational modification (by e.g., 'core glycosylation'). Transport vesicles bud off of the RER and carry packaged and membrane proteins to the cis vesicles of the Golgi apparatus. Vesicle fusion is mediated by the recognition of complementary integral membrane proteins on the two membranes. Later when packaged proteins must be sorted to different organelles or to the plasma membrane, specific proteins with affinities for different packaged proteins (and the vesicles containing them) sort the proteins to their final destinations and enable appropriate membrane fusion.

Some of these events of protein trafficking are animated at http://youtu.be/csQ_e92C-Q and summarized in the illustration below.

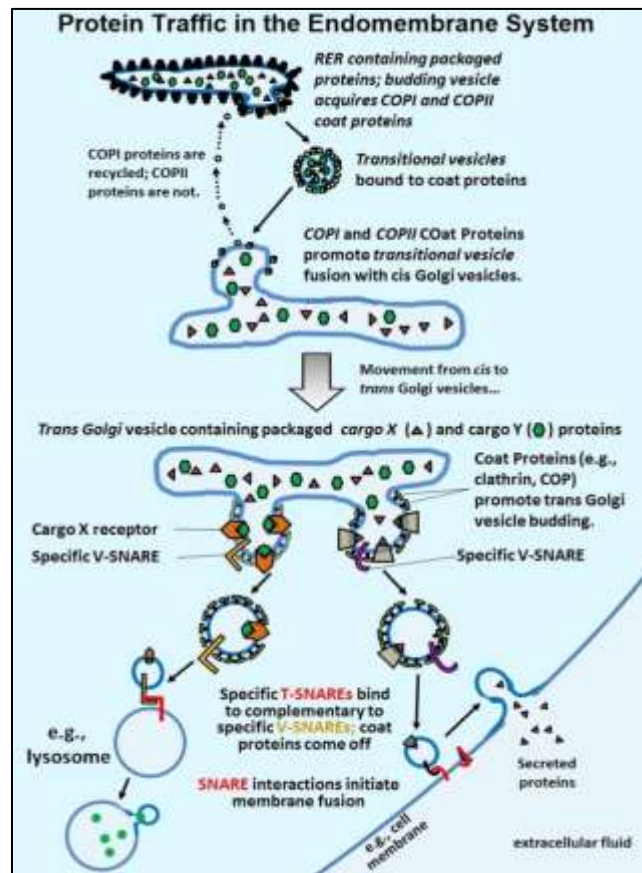

Their discoveries of machinery regulating vesicle traffic garnered the 2013 Nobel Prize in Physiology or Medicine for James E. Rothman, Randy W. Schekman and Thomas C. Südhof (click http://www.nobelprize.org/nobel_prizes/medicine/laureates/2013/press.html for more information). Let's follow some proteins in and on RER membranes through the cell:

- **Transition vesicles** carrying their mix of packaged proteins bud off of RER with the help of **COP** (Coat Proteins). Transition vesicles are *smooth*, having lost the ribosomes that characterize RER.
- These vesicles fuse with the *cis* Golgi vesicles, a process also mediated by COP proteins. COPI proteins detach during or after fusion to be recycled back to the RER
- Packaged proteins and membrane proteins are further processed as they pass through the Golgi vesicle stack, for example undergoing terminal glycosylation.

- At the *trans* face of the Golgi vesicles, **cargo receptor** proteins in the membranes begin to bind specific packaged proteins (now called **cargo proteins**). With the help of **clathrin** and other *COP proteins*, cargo protein-bound receptor proteins bud off from the trans Golgi stack. But this time, specific cargo proteins are sequestered in separate vesicles as they are sorted to different destinations. These budding vesicles also acquire membrane **V-SNARE** (for vesicle-SNARE) proteins.

CHALLENGE: The role of cargo receptors in sorting packaged proteins should raise some questions in your mind! Speculate about where are these receptors coming from, and why they become active when they do.

- When **V-SNARE** proteins on their vesicles bind to **T-SNARE** (for target SNARE) proteins on receiving membranes, the membranes fuse.
 - Some vesicles follow this pathway, fusing with **lysosomes** or similar vesicles to stock them with appropriate enzymes and other protein content. Coat proteins come off of the fusing vesicle and are recycled while the vesicle contents are transferred.
 - Vesicles containing proteins to be secreted typically fuse to form larger **secretory vesicles**. Secretory vesicles can be stored until the cells are signaled to release their contents from the cell. At that point, secretion vesicles fuse with the plasma membrane, releasing their contents to the extracellular fluid. Once again, coat proteins and clathrin come off of the secretory vesicle during fusion.

Other players have been left out of this discussion, notably those that hydrolyze nucleotide triphosphates to provide the energy for this protein trafficking. Perhaps it should be no surprise that some of the molecular players in controlling protein traffic also have a role in receptor-mediated endocytosis (e.g., clathrin). After all, endocytosis is at least partly, molecular traffic in the opposite direction of vesicle formation and secretion.

1. Nuclear Protein Traffic

Almost all proteins are encoded in the nucleus and translated in the cytosol, including most of those found in nuclei, mitochondria and chloroplasts (see the *Endosymbiotic Hypothesis* for a description of intra-organellar gene expression). Proteins synthesized in the cytosol destined for these organelles contain oligopeptide traffic signals that direct them to their appropriate destinations.

We saw earlier that large molecules (mRNAs, tRNAs) and even whole particles (i.e., ribosomal subunits) cross the nuclear envelope through nuclear pores. As for proteins headed for the nucleus, a **nuclear localization signal** rich in positively charged amino acids (lysine, proline) enables binding to a negatively charged domain in a **nuclear transport receptor** protein in the cytosol (below).

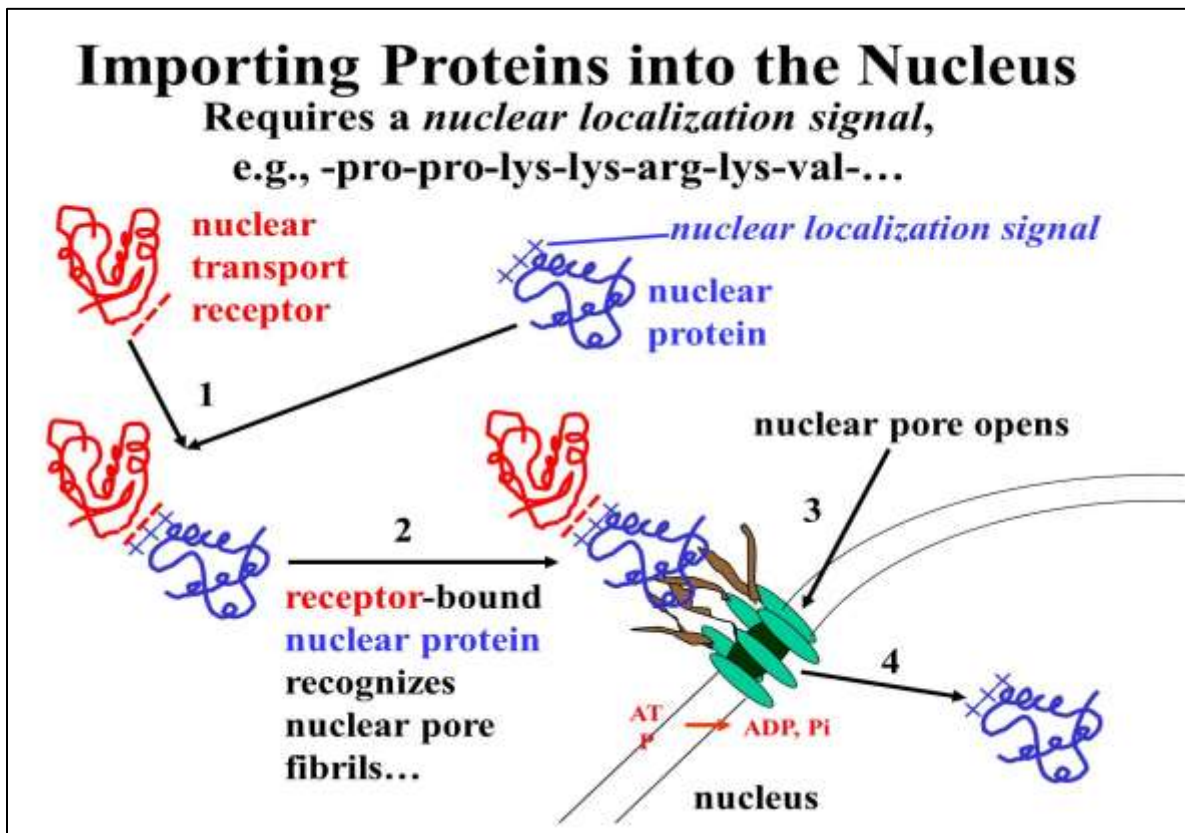

As the complex of the two proteins approach a *nuclear pore* it interacts with **nuclear pore fibrils**, causing the pore to open. The two bound proteins cross the double membrane of the nuclear envelope, accumulating against a concentration gradient. The *active transport* comes from ATP hydrolysis as the nuclear proteins enter the nucleus as animated at http://youtu.be/vgZHf_Ju-PQ.

3. Mitochondrial Protein Traffic

Recall that mitochondria contain their own genome and translational machinery, transcribing their own RNAs and translating their own proteins. However, many mitochondrial proteins are encoded by nuclear genes. These proteins are synthesized

with an N-terminal **signal sequence** which binds to a **receptor protein** that spans both the mitochondrial *outer membrane* (OM) and *cristal membrane* (CM), as illustrated below.

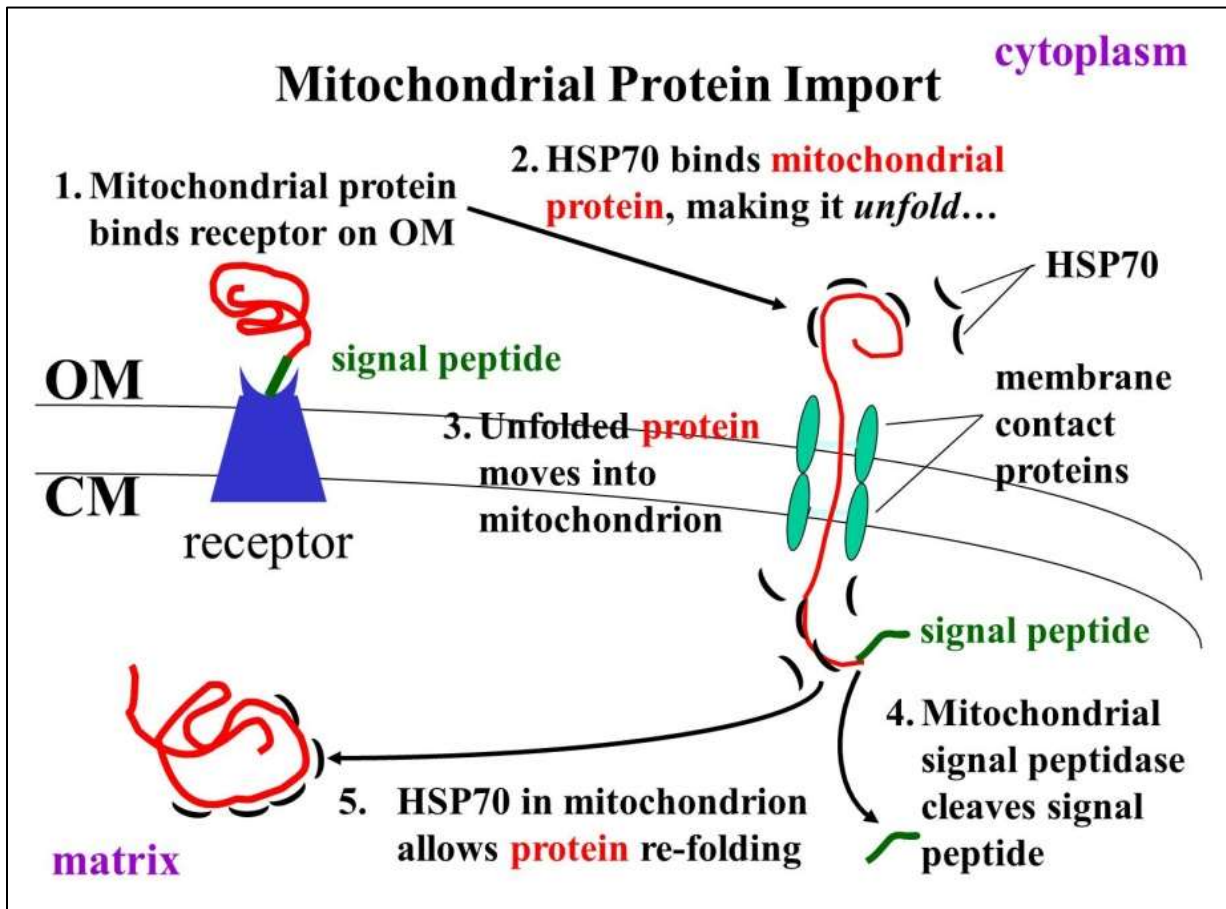

The receptor protein delivers the protein to **membrane contact proteins** that also span both mitochondrial membranes. The membrane contact proteins serve as a pore through which the protein crosses into the mitochondrial matrix. However, unlike the co-translational packaging of proteins by the RER, mitochondrial protein transfer is post-translational and involves a so-called **chaperone** protein, in this case the **HSP70** protein. An HSP70 protein enables unfolding of the mitochondrial protein as it passes into the matrix. After the signal peptide is removed by a **mitochondrial signal peptidase**, another HSP70 molecules in the mitochondria facilitate refolding of the protein into a biologically active shape. Recall that HSPs was initially discovered in heat stressed organisms, so that HSP70 is the acronym for *heat-shock protein 70*, a 70 Kd protein. The role of HSP70 mitochondrial import of cytosol proteins is animated at <http://youtu.be/cTlu79rhJYs>.

VI. How Cells are Held Together and How They Communicate

Proteins and glycoproteins on cell surfaces play a major role in how cells interact with their surroundings and with other cells. Some of the proteins in the **glycocalyx** of adjacent cells interact to form cell-cell junctions, while others interact with extracellular proteins and carbohydrates to form the **ECM** (extracellular matrix). Still others are part of receptor systems that bind hormones and other signaling molecules at the cell surface, conveying information into the cell by **signal transduction**.

A. Cell Junctions

1. Normal Cells

Junctions in healthy cells serve to bind cells tightly, to give tissues structural integrity and to allow cells in contact with one another to pass chemical information directly between them. Electron micrographs and illustrations of the 3 functionally different kinds of cell junctions are shown and described below.

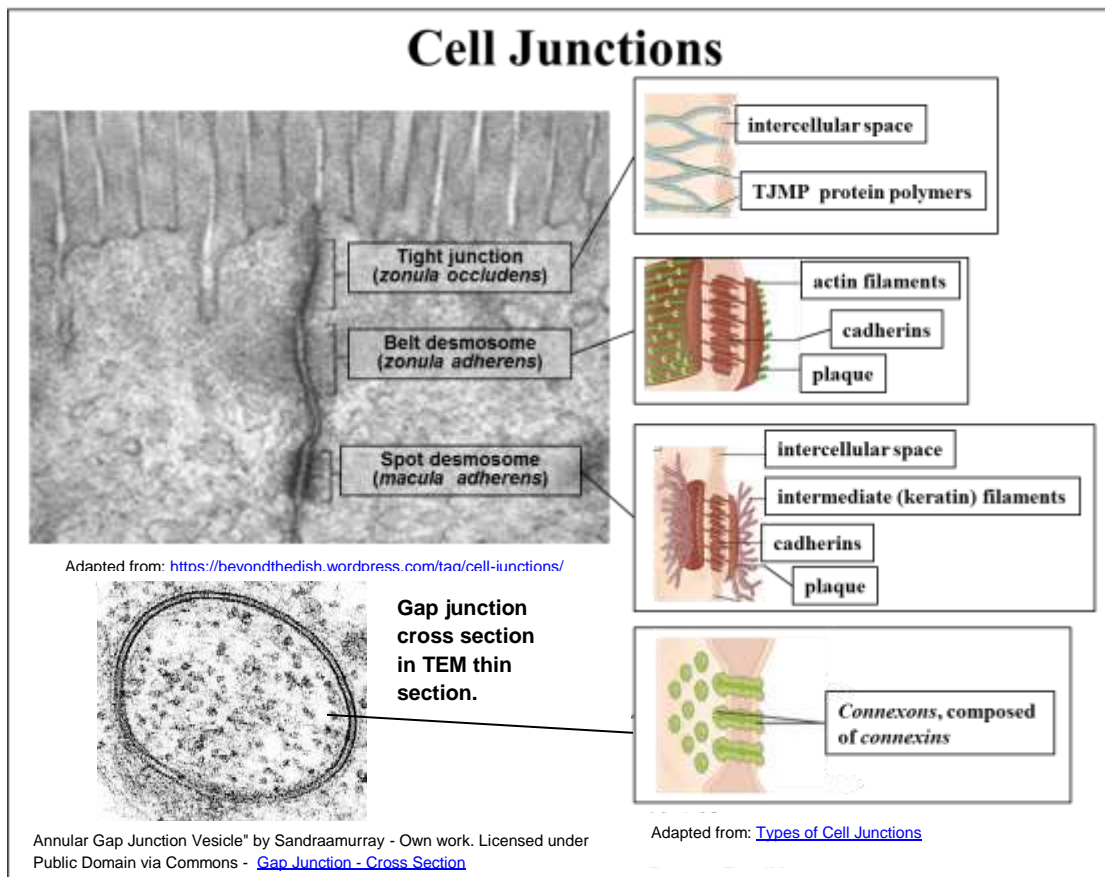

- a) **Tight Junctions**, also called *zonula occludens* are typical of epithelial sheets of cells that line the *lumens* of organs (e.g., intestines, lungs, etc.). *Zonula* refers to the fact that these structures form a band encircling an entire cell and attaching it to all surrounding cells. *Occludens* refers to the function of a tight junction, which is to form a 'water-tight' seal or *occluding barrier* that prevents extracellular fluids from crossing to the other side of the cell sheet by sneaking between the cells. The seal is made using TJMPs (*tight junction membrane proteins*) to create the waterproof barrier between cells.
- b) The micrographs show two kinds of **desmosomes**, both of which essentially glue (adhere) cells together, giving tissues their strength. **Belt desmosomes** (*zonula adherens*) surround entire cells, strongly binding them to other adjacent cells. Spot desmosomes (*macula adherens*) act like rivets, attaching cells at different points. In both cases, the glycoprotein **cadherin** crosses cell membranes from plaque proteins inside the cell, linking the membranes of adjacent cells together in the intracellular space between them. The plaques in turn are connected to intermediate filaments (keratin) of the cytoskeleton, further strengthening the cells and tissue cell layer.
- c) **Gap junctions** are the third kind cell 'junction'. They do not so much bind cells together physically as they enable chemical communication between cells. **Connexon** structures made of **connexin** proteins serve as pores that open to allow direct movement of ions and some small molecules between cells. This communication by ion or molecular movement is quite rapid, and ensures that all cells in a sheet or other tissue in one metabolic state can respond to each other and switch to another state simultaneously.

Most proteins interacting to form cell junctions are glycoproteins. The intercellular interactions of these glycofocalyx proteins are summarized below.

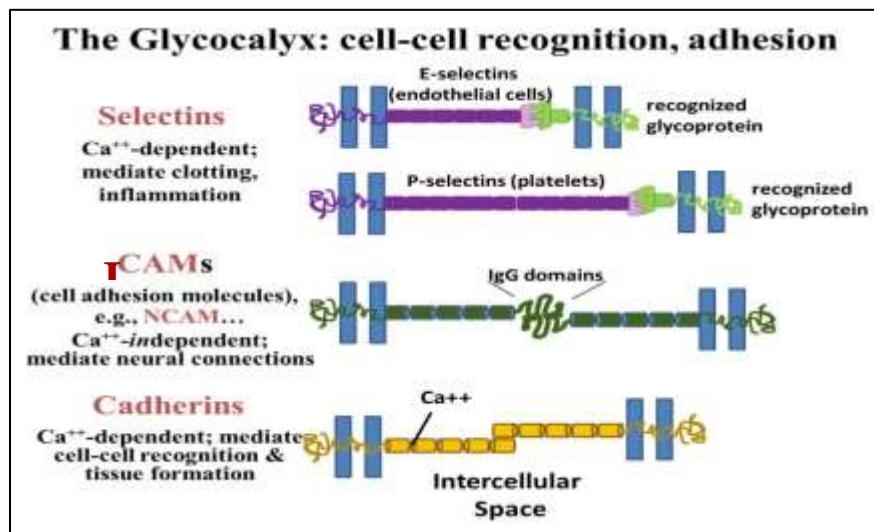

2. Cancer and Cell Junctions

During embryogenesis, cells migrate from their point(s) of origin by attaching to and moving along extracellular surfaces that serve as paths to their final destination. These *extracellular matrices* (or *basal lamina*) may have been secreted by other cells, or by the migrating cells themselves. *Integrins* in the cell membranes bind to *fibronectins* in the basal lamina to facilitate this attachment and even signal the cells to further differentiation into tissues and organs, complete with the formation of appropriate cell junctions. Orchestrating these events requires an orderly sequence of gene expression and membrane protein syntheses that enable developing cells to recognize each other as different or the same. The role of cell surfaces in tissue differentiation is summarized in the illustration below.

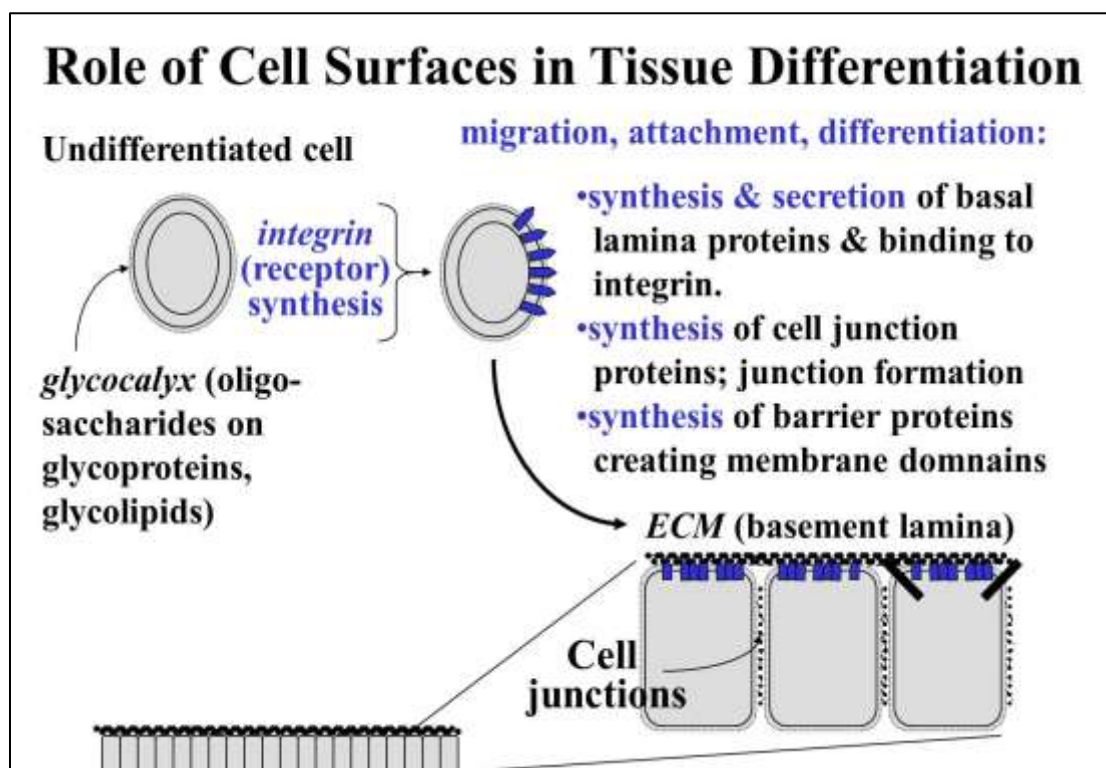

An early difference between eukaryotic normal and cancer cells is how they grow in culture. When a few normal cells are placed in growth medium in a culture dish they settle to the bottom of the dish. Then they grow and divide, increasing in number until they reach **confluence**, when a single layer of cells completely covers the bottom of the dish. The cells in this monolayer seem to 'know' to stop dividing, as if they had completed formation of a tissue, e.g., a cell layer of epithelial cells. This phenomenon

was originally called **contact inhibition**, implying that the cells let each other know that they have finished forming a tissue, and that they can stop cycling and dividing. In contrast, cancer cells do not stop dividing at confluence, but continue to grow and divide, piling up in multiple layers. These differences in growth in culture between normal and cancer cells are illustrated below.

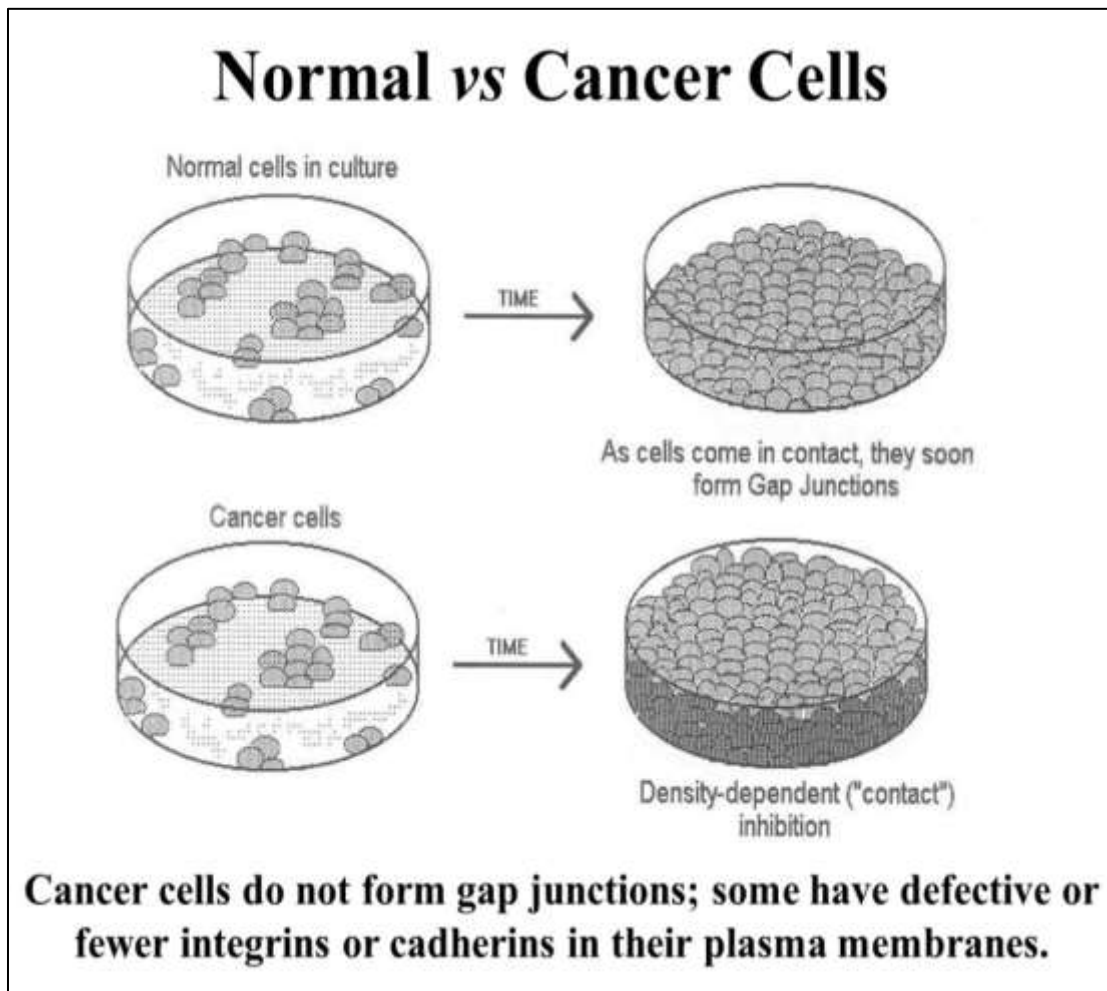

Among other deficiencies in cancer cells, they do not form *gap junctions* and typically have fewer *cadherens* and *integrins* in their membranes. Thus cancer cells can't inform each other when they reach confluence. Neither can they form firm *adherens junctions*. *In vivo*, a paucity of integrins would inhibit cancer cells from binding and responding to *fibronectin*. Therefore they also have difficulty attaching firmly to an extracellular matrix, which may explain why many cancers metastasize, or spread from their original site of formation.

VII. Signal Transduction

When hydrophobic chemical effector molecules such as steroid hormones reach a target cell they can cross the hydrophobic membrane and bind to an intracellular receptor to initiate a response. When large **effector** molecules (like protein hormones) or highly polar hormones like adrenalin reach a target cell, they can't cross the cell membrane. Instead they bind to cell surfaces via transmembrane protein receptors. A conformational change initiated on the extracellular domain of the receptor induces further allosteric change on the cytoplasmic domain of the receptor. A series of molecular events then converts information delivered by the external effector into intracellular information, a process called **signal transduction**. A general outline of signal transduction events is illustrated below.

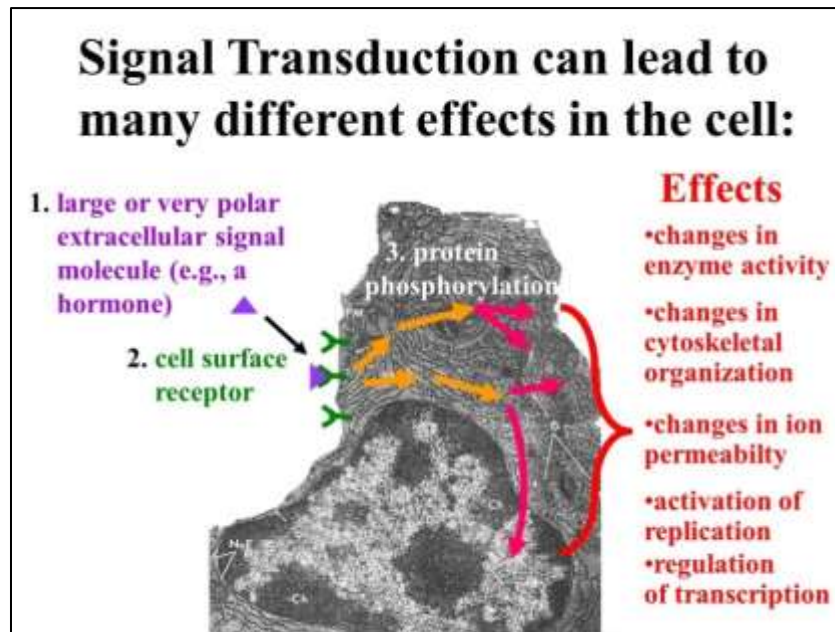

Many effects of signal transduction are mediated by a sequence of protein phosphorylations catalyzed by *protein kinases* inside the cell. Here we consider **G Protein-linked** and **enzyme-linked receptors**.

A. G-Protein Mediated Signal Transduction

GTP-binding proteins (**G-Proteins**) transduce extracellular signals by inducing production of different **second messenger** molecules in the cells. When hormones or other effector (signal) molecules bind to their membrane receptors, an allosteric change on the *cytoplasmic domain* of the receptor increases the affinity of the receptor for G proteins on the inner plasma membrane surface. G proteins are *trimers* consisting of α , β and γ subunits.

G-protein-mediated signal transduction is illustrated in 7 steps below.

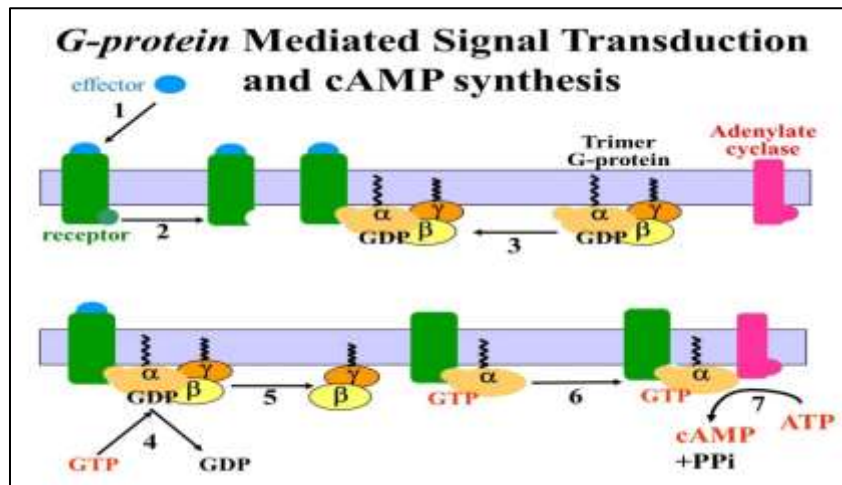

The receptor changes shape upon binding its effector signal molecule (steps 1 and 2). In this conformation, the receptor recognizes and binds to the G-protein trimer on the cytoplasmic surface of the plasma membrane (step 3). Upon binding of the trimer to the receptor, GTP displaces GDP on the α subunit of the G-protein (step 4). After a conformational change, the α subunit dissociates from the β and γ subunits (step 5). In this illustration, the GTP- α subunit is now able to bind to the transmembrane adenylate cyclase enzyme (step 6). Finally the initial extracellular chemical signal is **transduced** to an intracellular response involving second messenger molecules (step 7). In this case the second messenger is cAMP.

cAMP and other second messengers such as IP_3 , DAG or Ca^{++} ions (see below) typically activate the first in a series of protein kinases that catalyze the phosphorylation of proteins. Two kinases (**protein kinase A** and **protein kinase C**) play major roles in starting these phosphorylations, leading to **amplification cascades** in which the activation of just a few enzymes results in the activation of many more enzymes, thus amplifying the cell's original response to the effector

A key feature of response to hormones and other chemical signals is that when the cellular response is no longer needed by the organism, the production of the signal (hormone or other) goes down, the effector molecules dissociate from their receptors and the response stops. This is all possible because binding of signals to their receptors is freely reversible! An animation of adenylate cyclase activation illustrates what happens when levels of the effector molecule drop outside the cell, beginning with its dissociation from the receptor (<http://youtu.be/Se9N5sKmYcE>).

B. Signal Transduction using PKA

Many G-protein mediated effector responses begin by activating the integral membrane **adenylate cyclase**. The enzyme catalyzes the hydrolysis of pyrophosphate (PPi) from ATP and results in c-AMP synthesis. An example of a G-Protein-mediated response involving cAMP is the **fight-or-flight** response to adrenaline in liver cells of higher animals illustrated below.

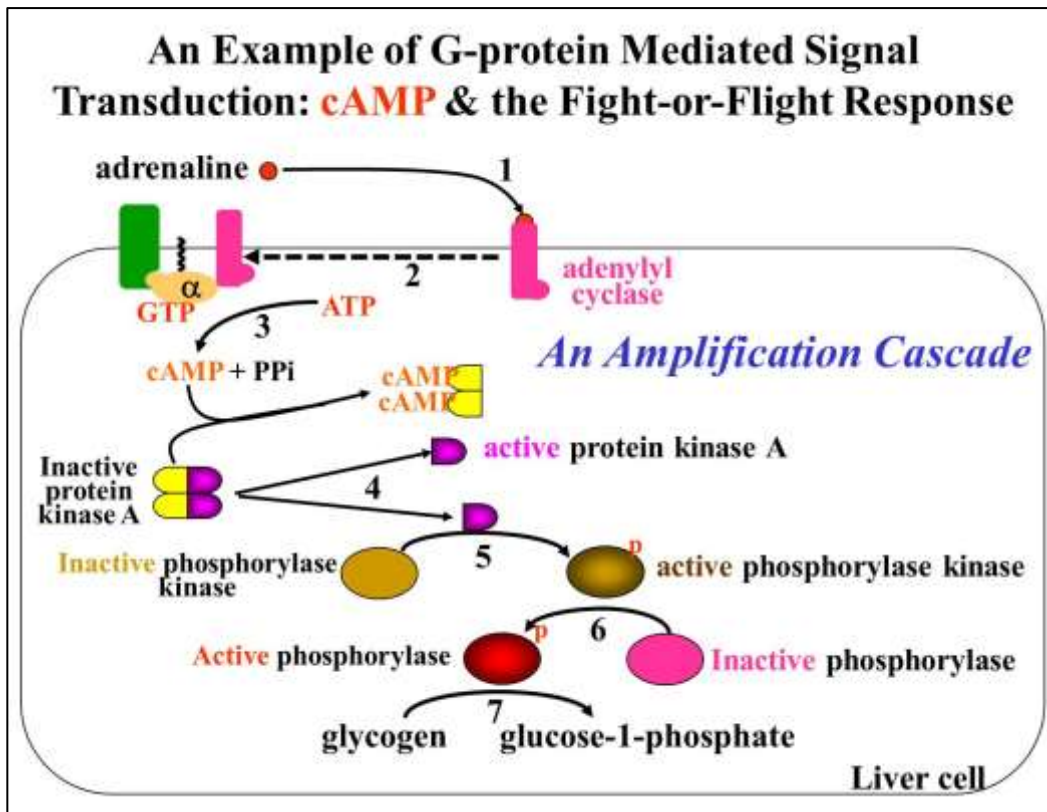

After adrenalin, binds to its receptor, a G-protein mediated adenylyl cyclase catalyzes cAMP production (steps 1 and 2 in the illustration). The cAMP in the cytosol binds to two of four subunits of an inactive enzyme protein kinase A (**PKA**) (step 3). A conformational change dissociates the tetramer into two cAMP-bound inert subunits and two **active PKA** subunits (step 4), each of which catalyzes phosphorylation and activation of an enzyme called **phosphorylase kinase** (step 5). Phosphorylase kinase in turn catalyzes phosphorylation of (glycogen) **phosphorylase** (step 6). Active *glycogen phosphorylase* then catalyzes the hydrolysis glycogen to glucose-1-phosphate (step 7). This results in a rapid retrieval free glucose from liver cells into the circulation (review glycolysis and gluconeogenesis). Of course, the increase in circulating glucose provides energy for the *fight-or-flight* decision. These events are animated at <http://youtu.be/fz9lrqm0lyg>.

In addition to activating enzymes that break down glycogen, cAMP-PKA mediates cellular responses to different effectors resulting in activation of kinases leading to

- Activation of enzymes catalyzing glycogen synthesis.
- Activation of *lipases* that hydrolyze fatty acids from triglycerides.
- Microtubule assembly.
- Microtubule disassembly.
- Mitogenic effects (activation of enzymes of replication).
- Activation of transcription factors increasing/decreasing gene expression.

C. Signal Transduction using PKC

PKC is activated by a G-Protein mediated pathway, but cellular responses are mediated by different second messengers. Like signal transduction using PKA, those using PKC lead to diverse effects in different cells or even in the same cells using different effector signals. PKC kinase effects are mediated by G-protein induced second messengers including **IP₃** (*inositol phosphate-3*) and **DAG** (*diacyl glycerol*) as shown below.

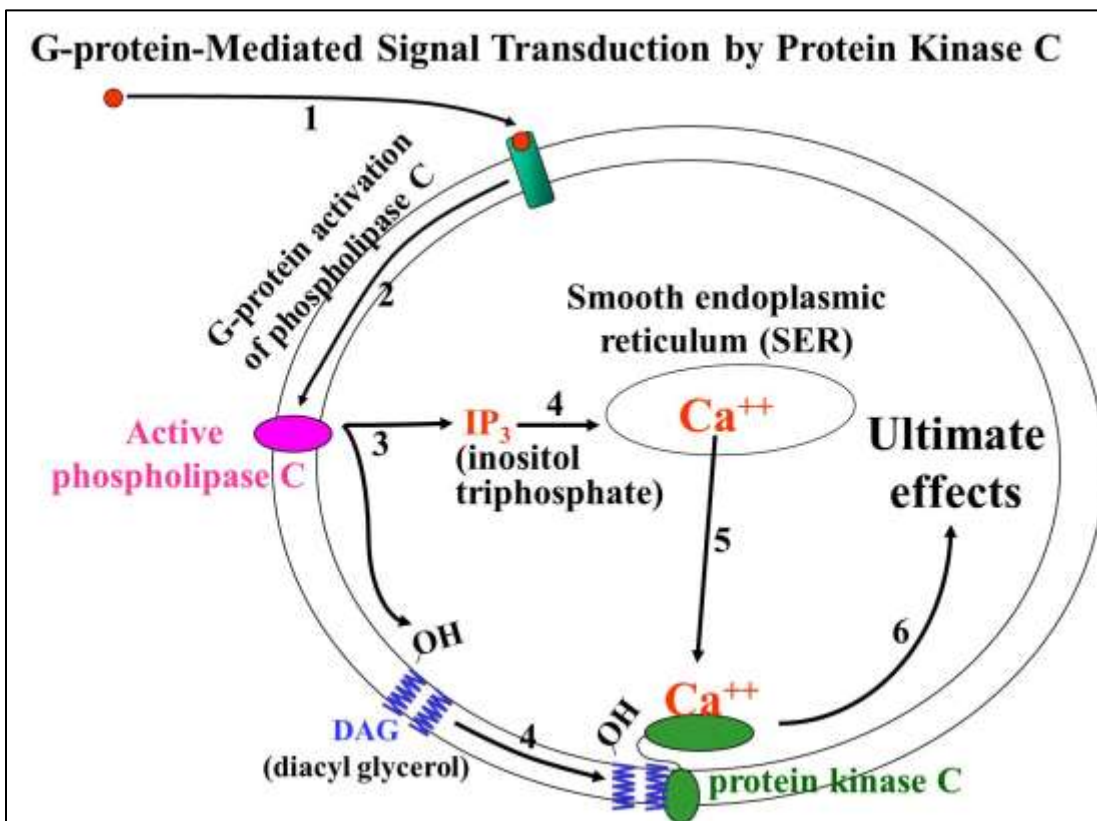

Like adenylate cyclase, activation of the integral membrane **phospholipase C** is mediated by G proteins in response to extracellular signals (steps 1 and 2 in the illustration). In step 3, phospholipase C action generates cytosolic **inositol triphosphate (IP₃)** and membrane bound **diacyl glycerol (DAG)**. IP₃ interacts with receptors on smooth endoplasmic reticulum (step 4), causing calcium ions sequestered there to be released into the cytoplasm (step 5). Ca⁺⁺ and DAG activate **Protein Kinase C (PKC)**. Active PKC then initiates a phosphorylation amplification cascade leading cell-specific responses. **PKC** effects include:

- Neurotransmitter release.
- Hormone (growth hormone, leutinizing hormone, testosterone) secretion leading to cell growth, division and differentiation.
- Glycogen hydrolysis, fat synthesis.

Additional **phospholipase C** effects include:

- Liver glycogen breakdown.
- Pancreatic amylase secretion.
- Platelet aggregation

PKA and PKC are called **serine-threonine kinases** because they place phosphates on serine or threonine in target polypeptides. This distinguishes their activity from the receptor-mediated kinases discussed next.

D. Receptor Tyrosine Kinase-Mediated Signal Transduction

These combined receptor-kinases catalyze the phosphorylation of specific tyrosines in target proteins. Furthermore, this kinase activity is in the cytoplasmic domain of the receptor itself. Stanley Cohen and Rita Levi-Montalcini studied the effects and mechanism of action of **nerve growth factor (NGF)** and **epidermal growth factor (EGF)**, chemical signals that stimulated growth and differentiation of nerve and skin. Cohen's work included the discovery of the EGF receptor, the first **enzyme-linked kinase** (which was also the first tyrosine kinase) to be described.

When monomer membrane receptor kinases bind their effector ligand, they dimerize, at which point sulfhydryl group-containing **SH₂ proteins** bind to each monomer, activating the kinase domain. These initial events in receptor kinase signaling are animated at <http://youtu.be/Czs2hIWvCQQ>. After multiple cross-phosphorylations of the receptor monomers, the SH₂ proteins fall away allowing the receptors to interact with other cytoplasmic proteins in the response pathway. The basics of this complex pathway are best viewed in the animation at <http://youtu.be/FjS6HtpLOgE>.

Many so-called cancer genes, or **oncogenes**, are really mutations of genes involved in normal growth and differentiation. Some of these are in mitogenic signal transduction pathways. Under normal circumstances, mitogenic chemical signals (like *EGF*) bind to their receptors and induce target cells to begin dividing. Mutations in genes for proteins in these signal transduction pathways (a well-studied example is animated at <http://youtu.be/m9cVMHFKDhY>) can leave them active even in the absence of timely signaling, resulting in uncontrolled (cancerous) cell division. **MAP (mitogen-activated protein) kinase** is a central protein in receptor kinase signaling pathways.

CHALLENGE: What kind of mutation in the MAP kinase gene do you imagine could cause cancer?

This enzyme can phosphorylate inactive *transcription factors* and other nuclear proteins that affect gene activity leading to cell proliferation and differentiation, as illustrated below.

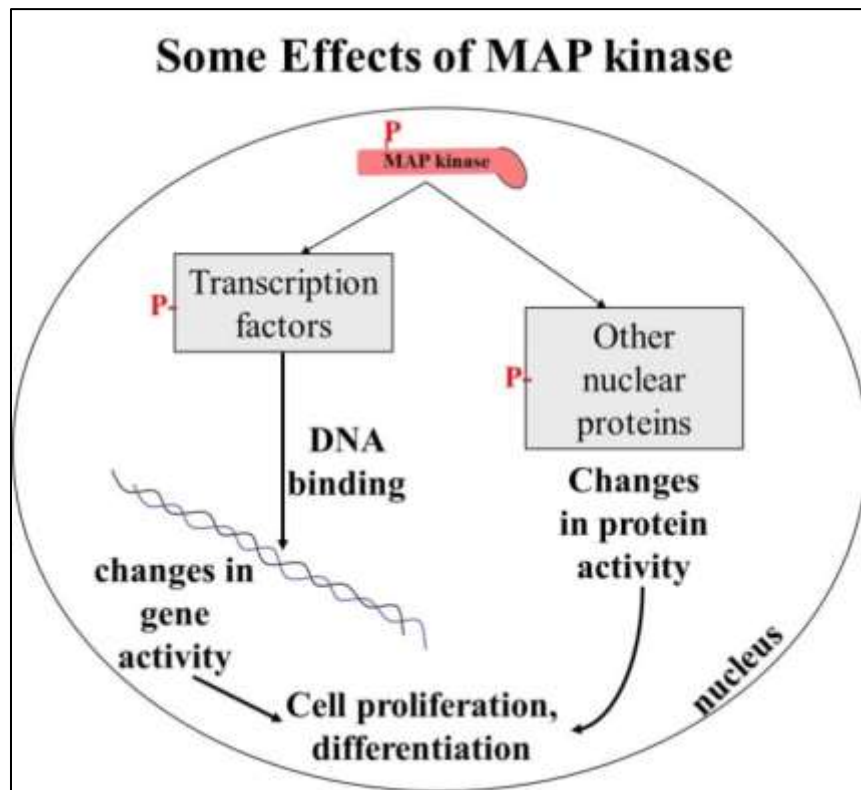

CHALLENGE: What some of these “other nuclear proteins” might be!

E. Signal Transduction in Evolution

We have seen that signal transduction characteristically takes a few signal molecules interacting with cell surface receptors and amplifies a response in a cascade of enzymatic reactions in which proteins are phosphorylated to activate them (or in some cases, inactivate them). Amplification cascades can take a single effector-receptor interaction and magnify its effect in the cell by orders of magnitude, making the signaling systems highly efficient. The range of cellular and systemic (organismic) responses to the same chemical signal is broad and complex since different cell types can have receptors for the same effector, but will respond differently. Thus, adrenaline is a hormone that targets liver cells and blood vessels among others, with different effects in each cell type. And, adrenaline is also a neurotransmitter. What seems to have happened in evolution is that as organisms became more complex in response to environmental imperatives, they have adapted by co-opting already existing signaling systems in the service of new pathways. Just as the same signal transduction event can lead to different pathways of response in different cells, evolution has allowed different signal transduction pathways to engage in **crosstalk**. This is when two different signal transduction pathways intersect in the same cells. In one example, the cAMP produced at the front end of the PKA signaling pathway can activate (or under the right circumstances, inhibit) enzymes in the MAP kinase pathway. These effects result in changes in the levels of active or inactive transcription factors and therefore a modulation of gene expression by two (or more) signals. We are only beginning to understand what looks less like a linear pathway and more like a web of signal transduction.

Some iText & VOP Key Words and Terms

action potential	fight-or-flight	peroxisomes
active transport	flaccid	phagocytosis
adaptin	free energy	phospholipase C
adenylate cyclase	G protein subunits	phosphorylase kinase
adherens junctions	gap junctions	pinocytosis
adrenaline	gluconeogenesis	PKA
allosteric change regulates transport	GLUT1	PKC
antiport	glycolysis	plasmodesmata
aquaporins	good cholesterol	plasmolysis
bad cholesterol	G-Protein-linked receptors	poikilothermic organisms
basal lamina	Heat shock protein	potential difference

belt desmosomes	HSP70 protein	Protein kinase A
Ca ⁺⁺ ions	hydrophilic corridor	protein kinase C
cadherin	hypertonic	protein packaging
cargo receptor	hypotonic	protein phosphorylation
carrier proteins	IgG light chain	proton gate
cell adhesion molecules	inositol triphosphate	proton pump
cell-cell attachment	integrin	receptor-mediated endocytosis
cell-cell recognition	ion channels	RER membrane
cell-free translation	ion flow	resting potential
channel proteins	ion pumps	secondary active transporters
chaperone proteins	IP ₃	serine-threonine kinases
cholesterol effects in membranes	isotonic	signal peptide
clathrin	LDL (low density lipoprotein)	signal recognition particle
coated pits	ligand (chemically) gated channels	signal sequence
coated vesicle	lysosome	signal transduction
connexins	MAP kinase	Smooth endoplasmic reticulum
contact inhibition	mechanically gated channels	sodium-potassium pump
contractile vacuole	membrane depolarization	solute concentration gradients
COP	membrane hyperpolarization	solute transport
cotransport	membrane invagination	sorting vesicle
coupled transport	membrane potential	spot desmosomes
cytoskeleton	microbodies	stop-transfer sequence
DAG	mitochondrial membrane contact proteins	symport
diffusion kinetics	mitogenic effects	tight junction membrane proteins
early endosome	nerve growth factor	tight junctions

ECM	neurotransmitters	TJMPs
effector molecules	NGF	tonoplast
EGF	nuclear envelope	T-SNARE
endocytosis	nuclear pore fibrils	turgid
endomembrane system	nuclear transport receptor	turgor pressure
Enzyme-lined receptors	O-glycosylation	tyrsine kinases
epidermal growth factor	osmoregulation	uniport
excitability	osmosis	uphill v. downhill solute movement
exocytosis	osmotic pressure	voltage gated channels
facilitated diffusion	passive diffusion	V-SNARE
fibronectin	patch clamp techniques	

Chapter 16: The Cytoskeleton & Cell Motility

Microfilaments, intermediate filaments and microtubules – roles in cell structure, secretion, cell migration and other organelle movements



I. Overview of the Cytoskeleton

The cell as it appears in a microscope was long thought to be a bag of liquid surrounded by a membrane. The electron microscope revealed a cytoskeleton composed of tubes, rods and filaments in which other intracellular structures were enmeshed. We will compare the molecular compositions of these structures and their subunit proteins. The cytoskeleton accounts for the location of organelles in cells and the shapes of cells themselves. We'll see how cytoskeletal components also account for cell motility, which includes how cells and organisms move as well as how structures within cells (often vesicles) move from one part of the cell to another. These movements are not random! A long- and well-studied system of cell motility is the interaction of actin and myosin during skeletal muscle contraction. We will first consider a paradox which suggested that ATP was required for contraction AND for relaxation of *muscle fibers*. Then we look at experiments resolving the paradox. Some muscles in the animal body contract rhythmically with little or no control on the part of the animal (think heart). But animals do control when they contract their skeletal muscles, implying that this kind of contraction is regulated. We will take a look at the role calcium ions and the regulatory proteins that control skeletal muscle contraction.

Voice-Over PowerPoint Presentations

[Cytoskeleton: Microtubules, Microfilaments and Intermediate Filaments](#)

[Cytoskeleton: Actin, Myosin & the Muscle Contraction Paradox](#)

[Cytoskeleton: Resolving the Actin-Myosin \(Muscle\) Contraction Paradox](#)

[Cytoskeleton: Regulation of Skeletal Muscle Contraction](#)

Learning Objectives

When you have mastered the information in this chapter and the associated VOPs, you should be able to:

1. compare and contrast the roles of microfilaments and microtubules in different forms of *cell motility*
2. distinguish the roles of microfilaments, microtubules and intermediate filaments in the *maintenance and alteration of cell shape* and structure
3. state an hypothesis explaining how microtubules in cilia maintain their length
4. propose an experiment to determine which part of a *motor protein* has the *ATPase activity*
5. define the actin-myosin, or *contraction paradox*
6. outline the steps of the *contraction cycle* involving myosin and actin
7. compare and contrast “*sliding filament*” and flagellar structure and function
8. explain the *striations* of skeletal muscle seen in a light microscope, and why *smooth muscles* do not show striations
9. outline the structure of a skeletal muscle, from the whole muscle down to the sarcomere
10. propose alternate hypotheses to explain *hereditary muscle weakness* involving specific proteins/genes, and suggest how you might test one of them

II. Structure and Function of the Cytoskeleton

A. Overview

Based only on light microscopy, eukaryotic cells look like a membrane-bound sac of cytoplasm containing assorted organelles. But then cells undergoing mitosis were shown to undergo a dramatic structural re-organization. First, duplicated chromosomes (the duplicates are called chromatids) condense in the nucleus as the nucleus itself seems to dissolve. Then spindle fibers emerge and seem to pull the chromatids apart and draw them to opposite poles of the cell. Spindle fibers were later shown to be made up of bundles of microtubules, each microtubule a polymer of the protein tubulin.

A cell in *metaphase of mitosis* is shown in the micrograph below.

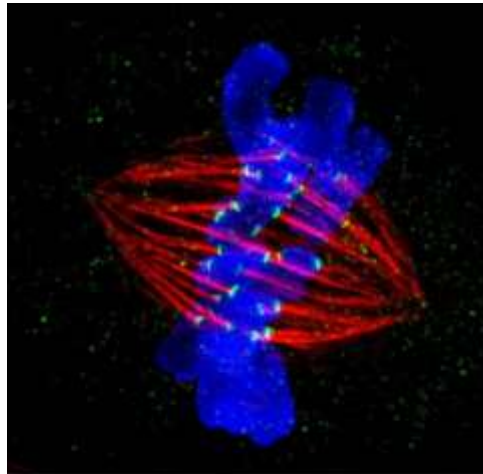

From: <http://cellimagelibrary.tumblr.com>

To obtain this micrograph, *immunofluorescence* techniques were used to stain microtubules (red), metaphase chromosomes (dark blue) and kinetochores to which the microtubules attach (green). Previously, antibodies had been made to purified microtubule and kinetochore proteins, and to chromosomal proteins (or to DNA). The antibodies themselves were purified and each was then covalently linked to a different *fluorophore* (organic fluorescent ‘tag’). The *fluorophores* emit different colors of visible light when they are irradiated with UV light in a fluorescence microscope.

Both mitosis and meiosis are eminently visible examples of movements within cells and so were described by the late 19th century. As for movement in whole organisms, mid-20th century studies focused on what the striations (or stripes) seen in skeletal muscle in the light microscope might have to do with muscle contraction. Investigators found that the striations were composed of a protein complex whose behavior upon extraction suggested at least two components. The complex was named **actomyosin** (*acto* for active; *myosin* for muscle). Electron microscopy later revealed that actomyosin (or *actinomyosin*) is composed of thin (**actin**) and thick (**myosin**) filaments that slide past one another during muscle contraction (see below).

At the same time, electron microscopy also hinted at a more complex cytoplasmic structure, even in non-muscle interphase cells. In fact, the cytosol is permeated by fine rods and tubes. The main components of the **cytoskeleton** are actin (**microfilaments**), **microtubules** and **intermediate filaments**. Even myosin is present in non-muscle cells, though in much lower amounts than in muscle cells!

The cytoskeleton gives cells mechanical strength and unique shape. In addition to cell division movements, the relationships between cytoskeletal components explains the motility of protists (paramecium, amoeba, phagocytes) and the organelle movement inside cells (you may have seen *cytoplasmic streaming* of chloroplasts on *Elodea*). Cytoskeletal components are dynamic. They can disassemble, reassemble and rearrange, allowing cells to change shape (e.g., creating *pseudopods* in amoeboid cells and the spindle fibers of mitosis and meiosis). The three main cytoskeletal filaments of eukaryotic cells are shown below, along with some of their physical properties:

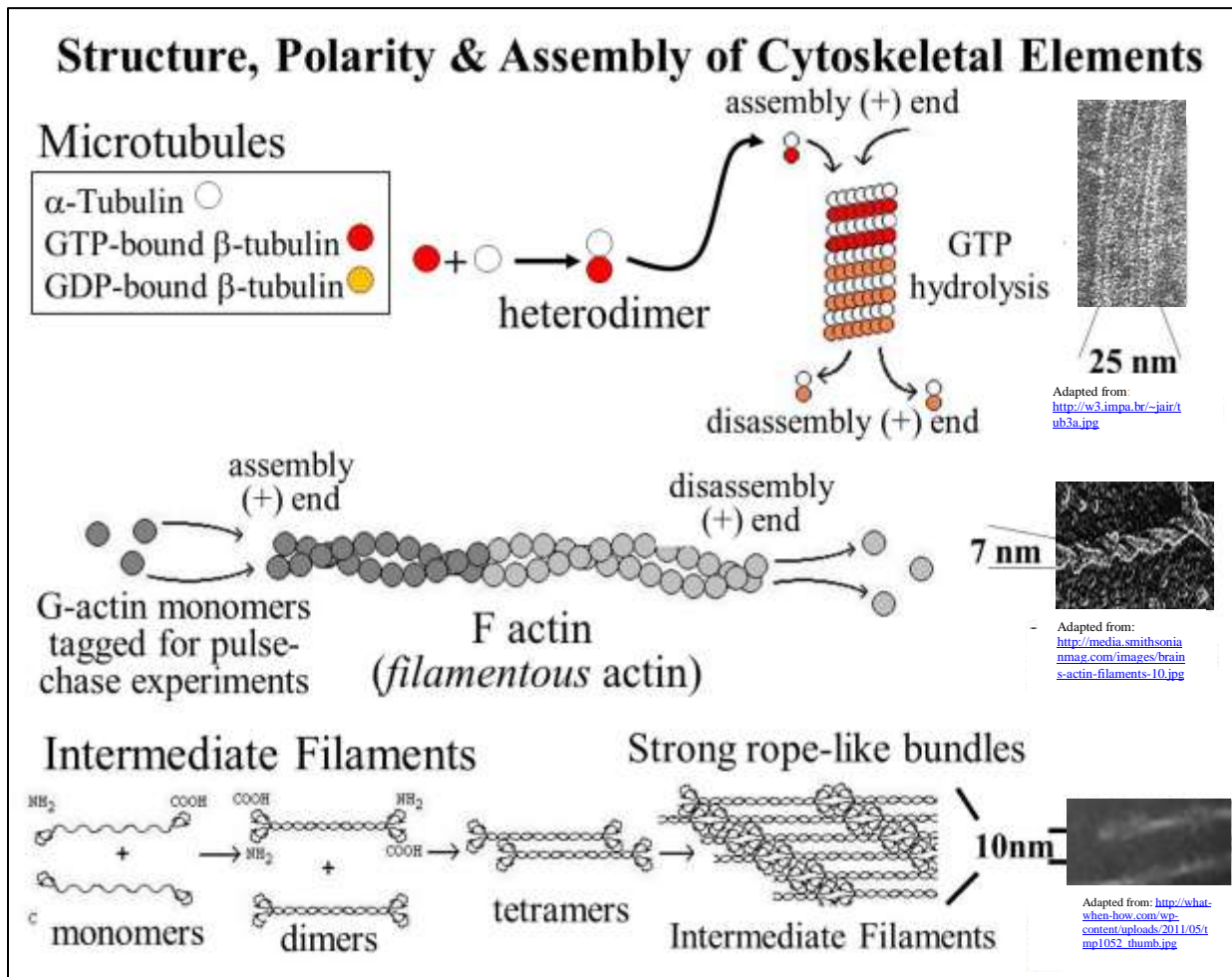

While intermediate filaments serve a mainly structural role in cells, microtubules and microfilaments have dual functions, both in maintaining and changing cell shape and in enabling cell motility. For example, by attaching to components of the plasma membrane, microfilaments contribute to maintain cell shape, but by interacting with

motor proteins in cells (e.g., *myosin*), they can move against the membrane causing changes in cell shape. Likewise, motor proteins such as *dynein* and *kinesin* proteins along microtubule tracks to bring 'cargo' from one point to another in the cell. The general location of different cytoskeletal components is shown in the illustration and micrographs of typical animal cells below:

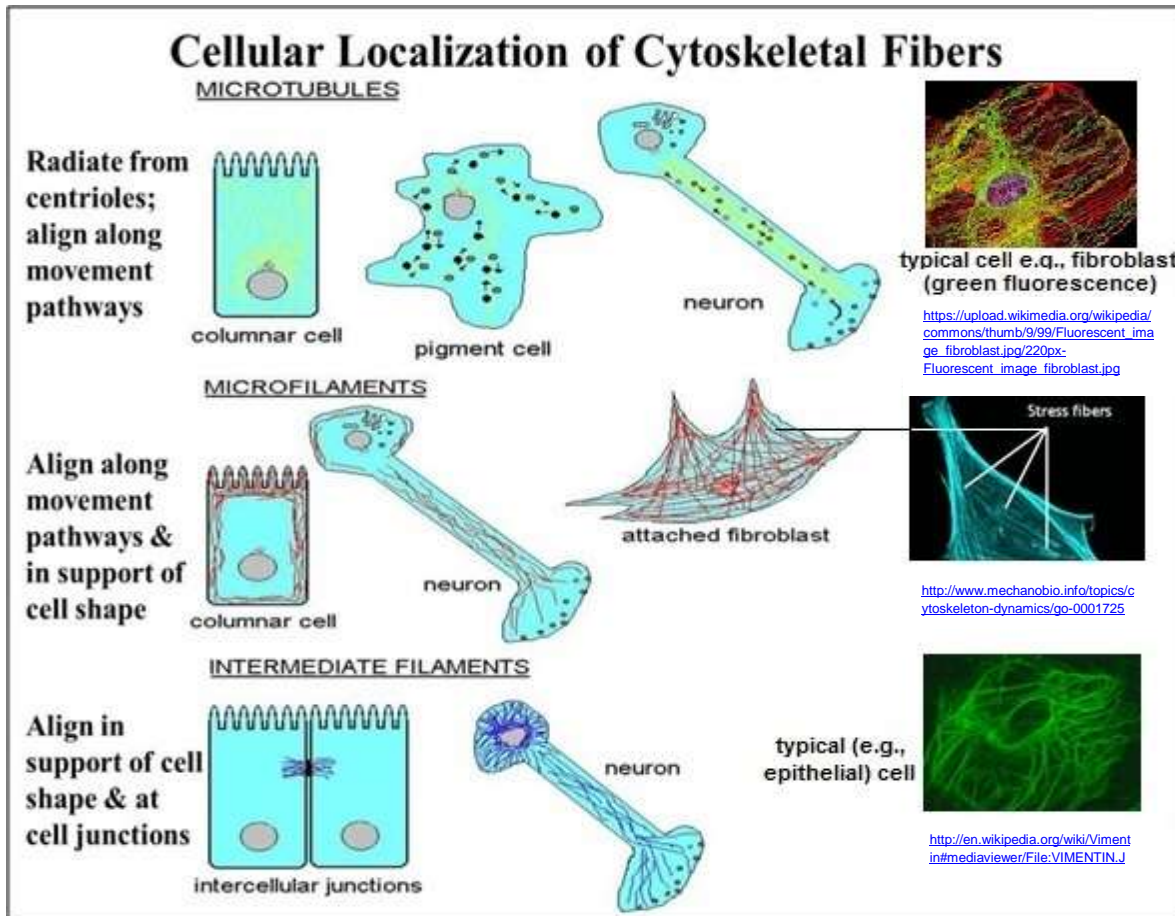

The micrographs in this illustration are immunofluorescence micrographs using fluorescence-tagged antibodies against either microtubule, actin (microfilament) or intermediate filament proteins. These localizations hint at (or are consistent with known) functions of microtubules, microfilaments and intermediate filaments in cell structure and motility.

More recently, elements of a cytoskeleton have been demonstrated in prokaryotic cells (<http://www.ncbi.nlm.nih.gov/pubmed/16959967>); thus *all* cells are more than a bag of sap with no particular organization! Next, we'll consider the role of microtubules, microfilaments, intermediate filaments and related proteins in the cytoskeleton.

B. Microtubules – an Overview

Microtubules assemble from α and β tubulin monomers. After forming α - β tubulin dimers, the dimers add to a growing *plus*, or **+end**. Assembly is fueled by *GTP hydrolysis*. Dynamic microtubules involved in changing the shape of cells or in spindle fibers during mitosis or meiosis will disassemble at the opposite *minus*, or **-end**.

Individual microtubules can be isolated. These ‘purified’ microtubules were shown to grow by addition to one end and to disassemble at the opposite end, thereby demonstrating +ends and –ends. A summary of the experiment that demonstrated this ‘polarity’ of microtubules is animated at <http://youtu.be/CkeYBSD9RJg>. Microtubules in cells can seem disordered, although they tend to radiate from centrioles in non-dividing animal cells. In dividing cells, we say that microtubule formation is *nucleated* from **centrioles** in animal cells and from a more amorphous **microtubule organizing center (MTOC)** in plant cells. A typical centriole (or basal body) in cross section has a ‘9 triplet’ microtubule array as seen below.

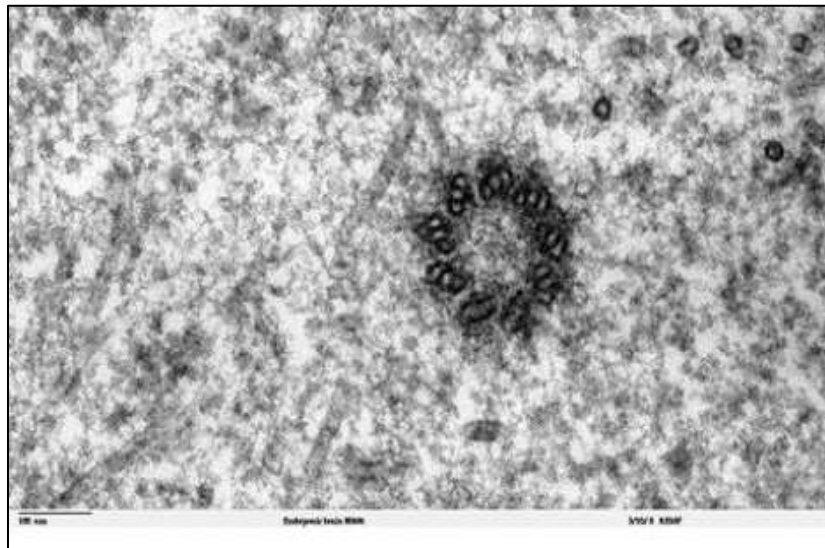

From: http://commons.wikimedia.org/wiki/File:Spindle_centriole_-_embryonic_brain_mouse_-_TEM.jpg

1. The Two kinds of Microtubules in Spindle Fibers

- **Kinetochores microtubules**

At **prophase** of mitosis and meiosis, duplicated chromosomes condense, becoming visible as paired **chromatids** attached at their **centromeres**. During condensation, proteins associate with the centromeres of the

chromatids to create a **kinetochore**. As the spindle apparatus forms, some spindle fibers attach to the kinetochore. By **metaphase** these spindles (bundles of microtubules) are seen stretching from kinetochores at the center of the cell to the centrioles or MTOCs of the dividing cells.

We now know that the *assembly* or growth ends (**+ends**) of kinetochore microtubules are at the kinetochore! At **anaphase**, chromatids are separated by forces generated when microtubules shorten at their disassembly ends (their **-ends**) at the centrioles/MTOC. Microtubule disassembly also provides the force that draws daughter chromosomes to the opposite poles of the cell as cell division continues.

- **Polar microtubules**

These microtubules extend from centrioles/MTOCs at the poles, overlapping at the center of dividing cells. These microtubules slide past one another in opposite directions during anaphase. The effect is to push apart the poles of the cell, even as the chromatids are being pulled to the opposite poles. But in this case, ATP hydrolysis powers a **motor protein** called **dynein** attached to one microtubule that in effect 'walks' along a microtubule extending from the opposite pole of the cell. The roles of polar and kinetochore microtubules are illustrated in below.

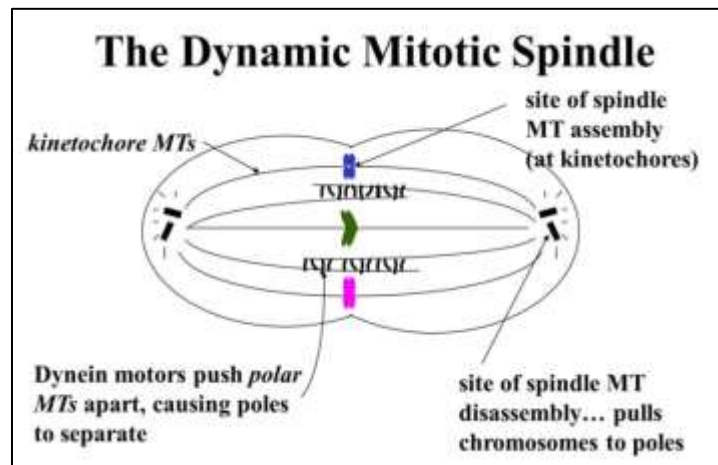

The role of microtubule disassembly at the centrioles (i.e., the minus end) was demonstrated in a clever experiment in which a tiny laser beam was aimed into a cell at spindle fibers attached to the kinetochore of a pair of chromatids. What happened when the laser cut the spindle fiber is animated at <http://youtu.be/1PSenpp7TmE>.

2. Microtubules in Cilia and Flagella

The microtubules of cilia or flagella emerge from a **basal body** (below left). Basal bodies are structurally similar to centrioles, organized as a ring of 9 triplets. Cilia and flagella formation begin at basal bodies but show a typical **9+2** (nine outer doublet plus two central) microtubule arrangement in cross section. When cilia or flagella are isolated and their membranes are removed, what remains is the axoneme, which preserved the 9+2 microtubule arrangement. Isolated axonemes can be seen with no surrounding membrane (below right).

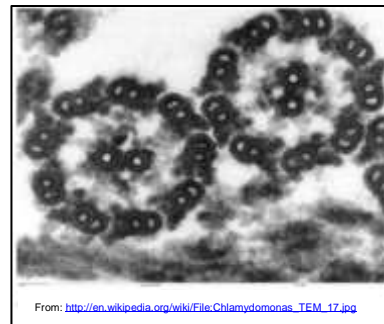
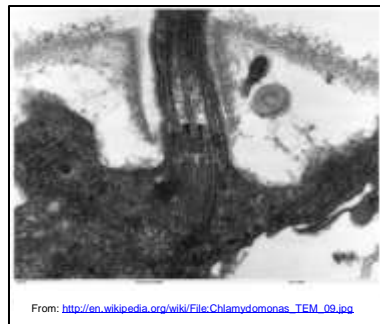

The structural relationship between the axoneme of a cilium or flagellum and an individual microtubule is shown below.

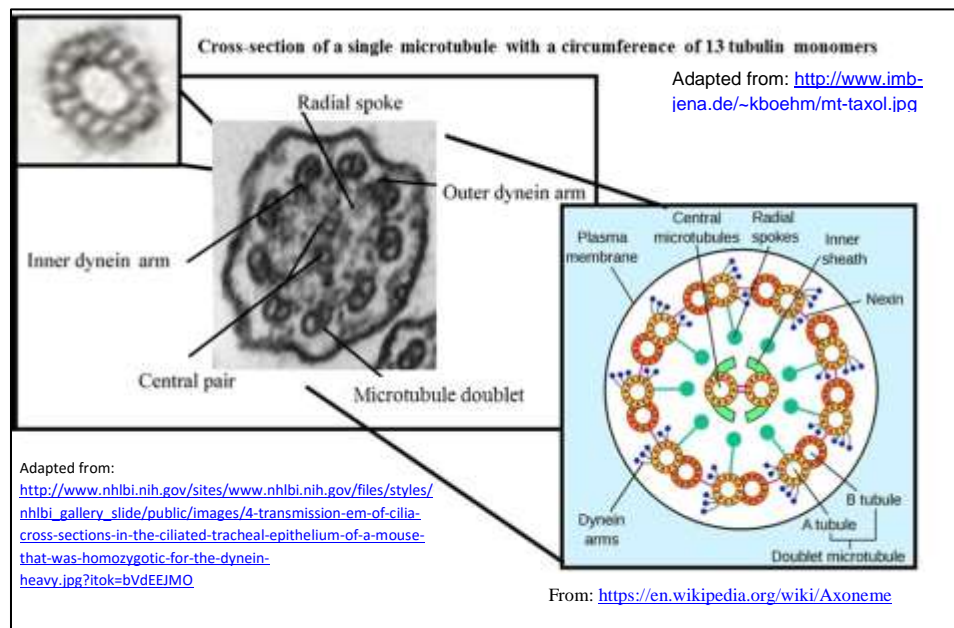

In cross section it is possible to see the tubulin subunits that make up a microtubule polymer. Each tubule is made up of a ring of 13 tubulin subunits. The microtubules in the 'doublets' share tubulins, but are also composed of 13 tubulins. When fully formed, the 25 nm diameter microtubules appear to be a hollow cylinder. But microtubules are typically isolated with motor proteins and other *Microtubule-Associated Proteins (MAPs)*.

3. *Microtubule Motor Proteins Move Cargo from Place to Place in Cells*

Motor proteins are ATPases that use the free energy of ATP hydrolysis to power cellular and intracellular motility. Let's take a closer look at how two major motor proteins, **dynein** and **kinesin**, carry cargo from place to place inside of cells. Organelles are a typical *cargo*. Examples include moving *secretory vesicles* trans Golgi vesicles to the plasma membrane for exocytosis. Vesicles containing *neurotransmitters* also move along microtubule tracks running from the cell body to the nerve ending. And in a chameleon moving between light and dark background foliage, *pigment vesicles* in skin cells disperse or aggregate along microtubule tracks to change skin color to match the background. The role of *kinesin* and *dynein* motor proteins in carrying neurotransmitter vesicles in opposite directions along axonal microtubules is well understood. Kinesin moves neurotransmitter vesicles (e.g., protein neurotransmitters made in the endomembrane system) to nerve endings (**anterograde** movement). In contrast, as part of a **dynein** complex, dynein moves empty vesicles back to the cell body (**retrograde** movement). This is illustrated below, along with some details of motor protein structure.

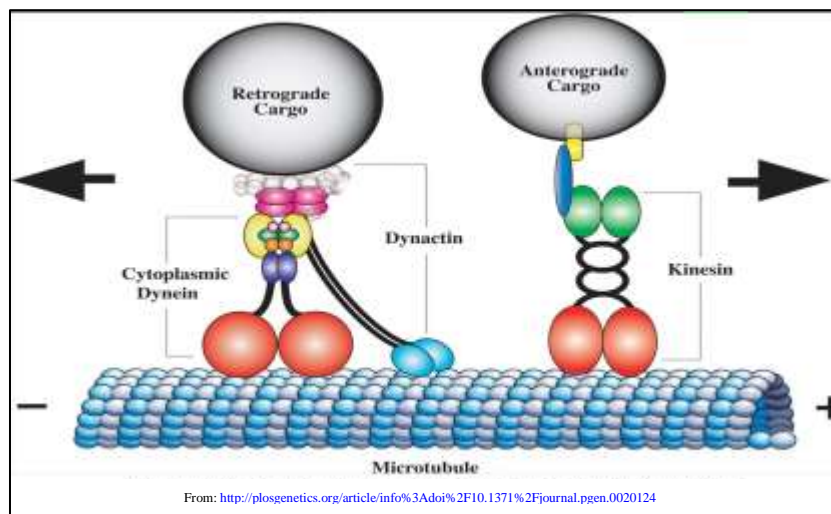

A fanciful (but not *too* inaccurate!) cartoon of a motor protein 'walking along an axonal microtubule is animated at this link: [Kinesin 'walking' an organelle along a microtubule](#). At this point we can look at several specific kinds of cell motility involving microtubules and microfilaments.

4. The Motor Protein Dynein Enables Axonemes to Bend

The movements of cilia and flagella are illustrated below.

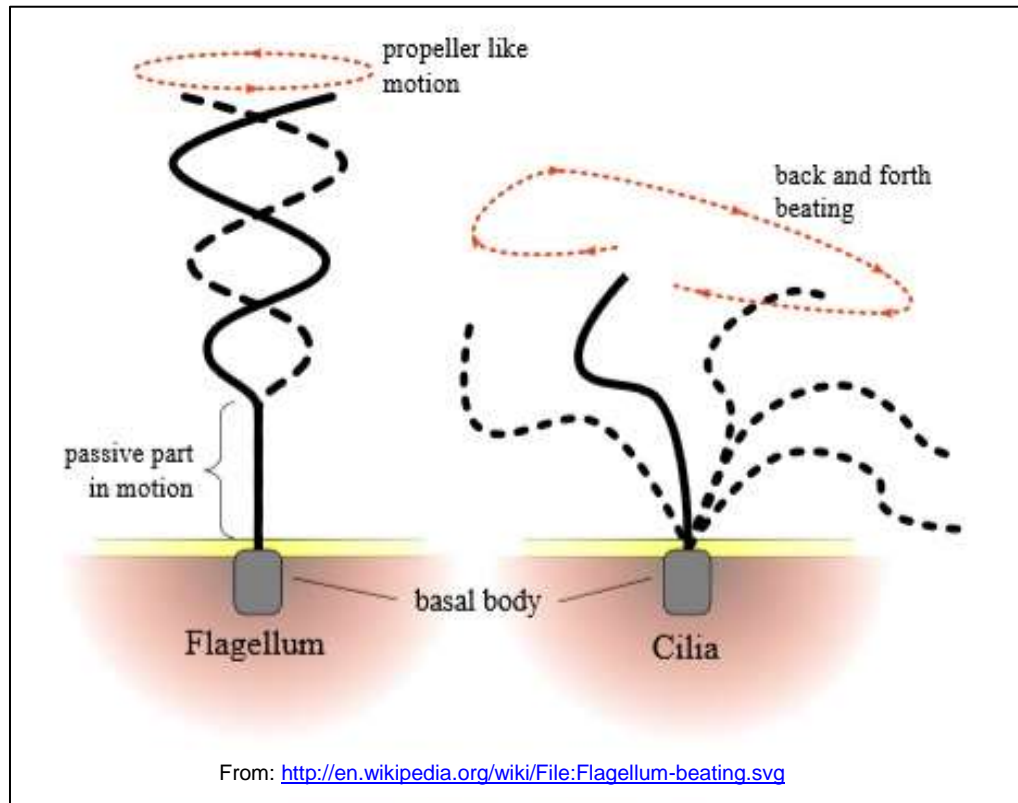

Take a look at the cross-section of axonemes a few illustrations ago. In the 9+2 axoneme of cilia and flagella, the dynein arms attached to the **A tubules** of the outer doublets walk along the **B tubules** of the adjacent doublet. When the doublets on only one side of an axoneme take a walk, the microtubules slide past one another. As a result, the axoneme (and therefore a cilium or flagellum) will bend. However, microtubule sliding is constrained by flexible **nexin** and **radial spoke** attachments. The differences in flagellar motion (wave-like propeller) and ciliary motion (single plane beat) are in part the result of which microtubules are sliding at a given moment, and the nature of their restraint by axoneme proteins. Let's look at some experiments that demonstrate these events.

The sliding microtubule mechanism of ciliary and flagellar motility was determined by experiments on isolated **axonemes**. One such experiment is illustrated below.

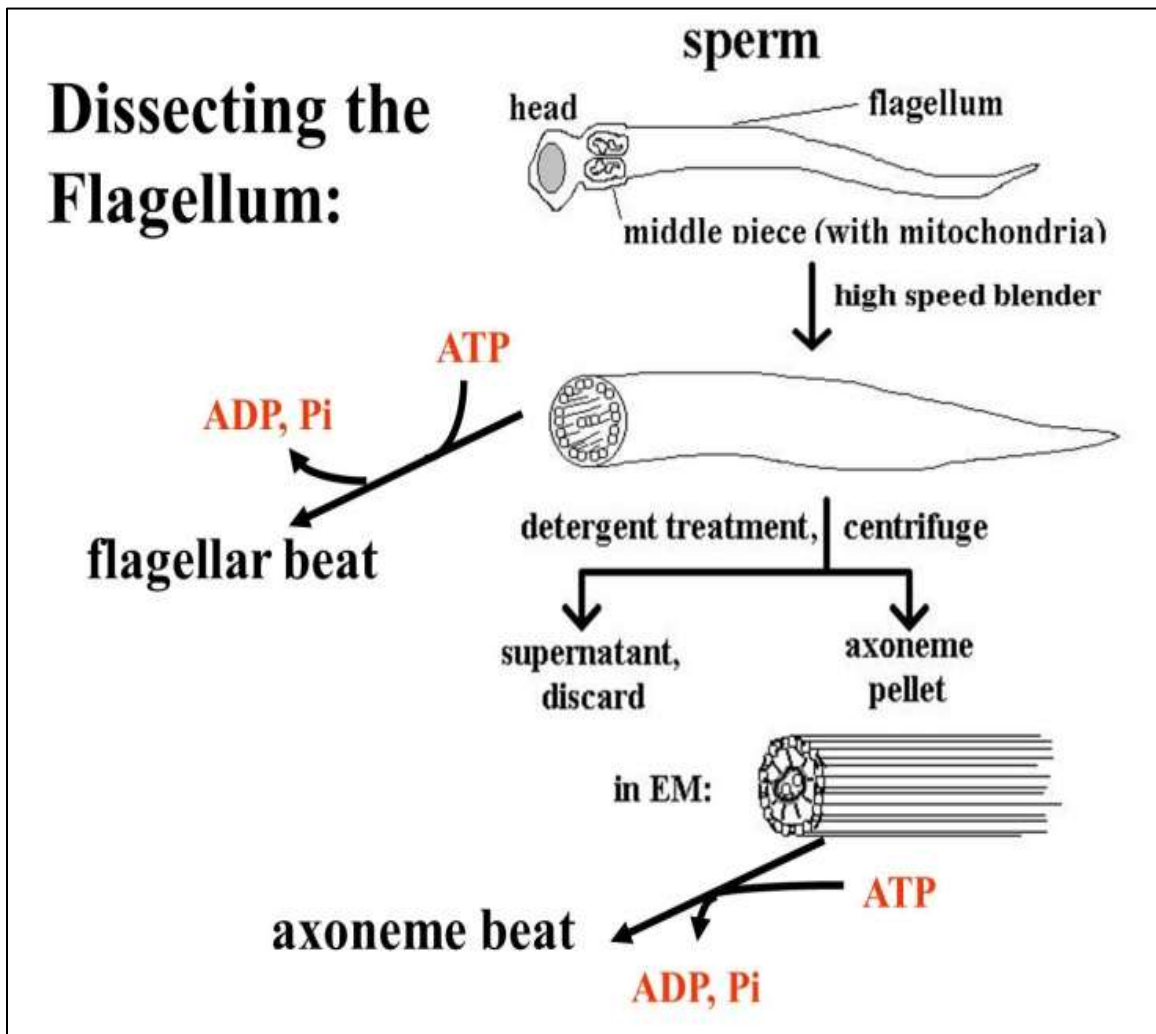

Agitating sperm or ciliated cells in a high speed blender for a few seconds will shear and detach flagella or cilia from the rest of the cell. Adding ATP to either will cause them to beat, a phenomenon easily seen in a light microscope. Axonemes isolated from detached cilia or flagella by *detergent treatment* (to disrupt membranes) retain their characteristic 9+2 microtubule arrangement as well as other ultrastructural features. And even isolated axonemes will beat in the presence of ATP!

Additional detergent treatment removes radial spokes, nexin and other proteins from the axoneme, causing the microtubules to separate. Dissociated microtubule doublets and central 'singlets' could be observed in the electron microscope. When such separated microtubules are dialyzed to remove the detergents, the doublet microtubules re-associate, forming sheets, as shown in the cartoon below.

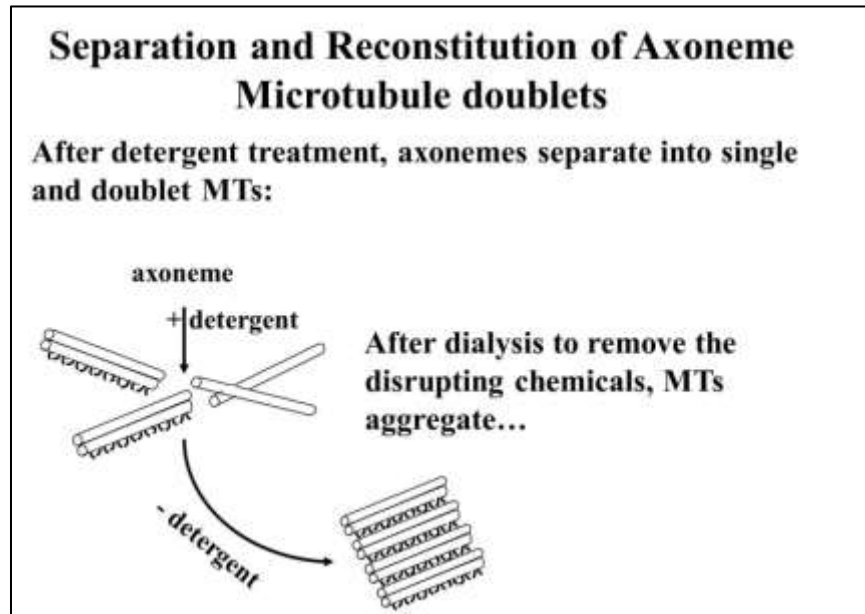

When ATP is added back to the 'reconstituted' microtubule doublets, they again separate as the ATP is hydrolyzed. And if such preparations are fixed for electron microscopy immediately after adding the ATP, they can be caught in the act of sliding! The interpretation of these electron microscope observations is at <http://youtu.be/Y6RBJfUpZec>.

C. Microfilaments – an Overview

At 7 nm in diameter, **microfilaments** (actin filaments) are the thinnest component of the cytoskeleton. Globular actin protein monomers (**G-actin**) polymerize to form a linear **F-actin** polymer. Two polymers combine to form the twin helical actin microfilament. As with microtubules, microfilaments have a **+end** to which new actin monomers are added to assemble the F-actin and a **-end** at which the microfilaments disassemble when they are in a dynamic state, such as when a cell is changing shape. When one end of a microfilament is anchored to a cellular structure, for example to **plaques** in the cell membrane, motor proteins (e.g., myosin) can use ATP to generate a *force* that deforms the plasma membrane and

thereby the shape of the cell. One of the best studied examples of myosin/actin interaction is in skeletal muscle where the sliding of highly organized thick myosin rods and actin microfilaments generates powers muscle contraction.

1. Microfilaments and Skeletal Muscle Contraction

Skeletal muscle is made up of bundles of parallel muscle cells (***myocytes***, ***myofibers*** and ***muscle fibers***). Thin sections of muscle viewed in a light microscope show myocytes to be *striated* (below).

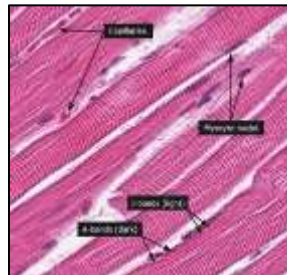

From: <http://www.bing.com/images/search?q=striated+myocytes&view=detailv2&id=4D186BBA18DB363F738F1D7CB72C71E8E3E58448&selectedIndex=3&ccid=L5bxGV3%2b&simid=607986296318752696&thid=JN.HQWsw7ZxuPQDs1Mwlu33cg>

The dark purplish structures surrounding the myocyte are *mitochondria*, which will provide the ATP to fuel contraction. The blow-out below shows how muscle cells are organized into muscles.

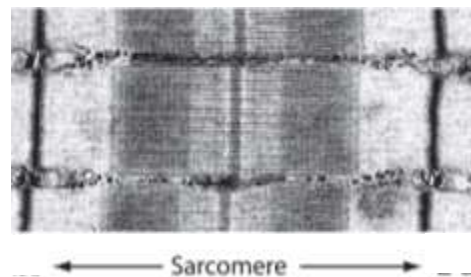
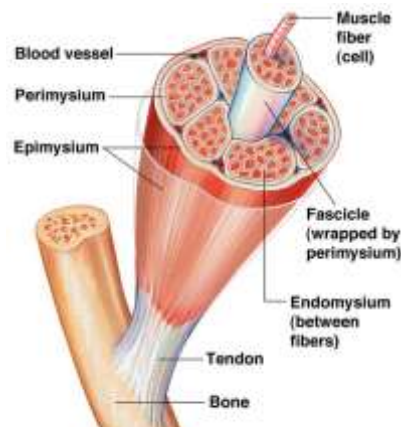

Adapted from: <http://www.ks.uiuc.edu/Research/telethonin/MuscleL1.jpg>

From: <https://chamodinim.files.wordpress.com/2013/04/muscle-diagram1.jpg>

Seen in the electron micrograph of a single ***myocyte***, the dark bands of the striations are part of ***sarcomeres***, which are repeating units of the molecular contractile apparatus. Multiples of these long repeating sarcomeres align in register in the myocyte to give the overall appearance of striations.

a. *The Contraction Paradox*

The role of ATP in fueling muscle contraction was a mystery for many years, based on an experiment in which muscle fibers were soaked in glycerin, which makes the plasma membranes permeable. All of the soluble components of the myocyte cytoplasm leak out of these **glycerinated fibers**. Investigators found that if ATP and calcium were added back to glycerinated fibers, they could still contract... and could even lift a weight (illustrated below).

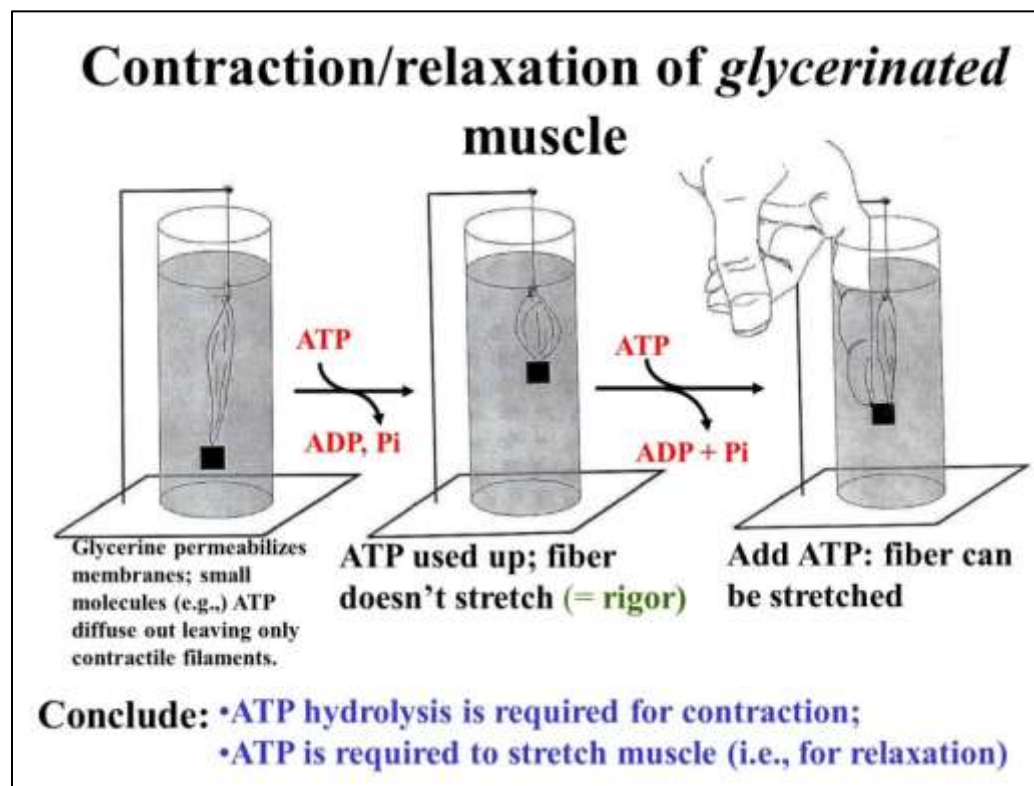

When assays showed that all of the added ATP had been hydrolyzed, the muscle would not relax, even with the weight it had lifted still attached!

Attempting to manually force the muscle back to its relaxed position didn't work. But if fresh ATP was added to the preparation, it was possible to stretch the fiber. And if after stretching the fiber the experimenter let go, the muscle would again contract and lift the weight. A cycle of forced stretching and contraction could be repeated until all of the ATP was hydrolyzed, at which point the fiber could no longer contract or could no longer be stretched.

The contraction paradox then, was that ATP hydrolysis was required for muscle contraction as *well as* for relaxation (stretching). The paradox was resolved when the functions of the molecular actors of contraction were finally understood. Here we review some of the classic experiments that led to this understanding.

b. ***Actomyosin and the Sliding Filament Model of Skeletal Muscle Contraction***

Early extractions of homogenates of skeletal muscle led to the isolation of a viscous substance named ***actomyosin*** (*acto* for active and *myosin* for muscle substance). Under the right conditions, adding ATP to actomyosin preparations caused a decrease in viscosity, but after a while (i.e., after the added ATP was hydrolyzed), the mixture became viscous again. Further extraction of the non-viscous preparation (before it re-congealed) led to the separation of two main substances, ***actin*** and ***myosin***. Adding these components back together reconstituted the viscous actomyosin extract (now often referred to as ***actinomyosin*** to reflect its composition).

High resolution electron microscopy in the 1940s revealed the fine structure of skeletal muscle, allowing characterization of the sarcomere (below).

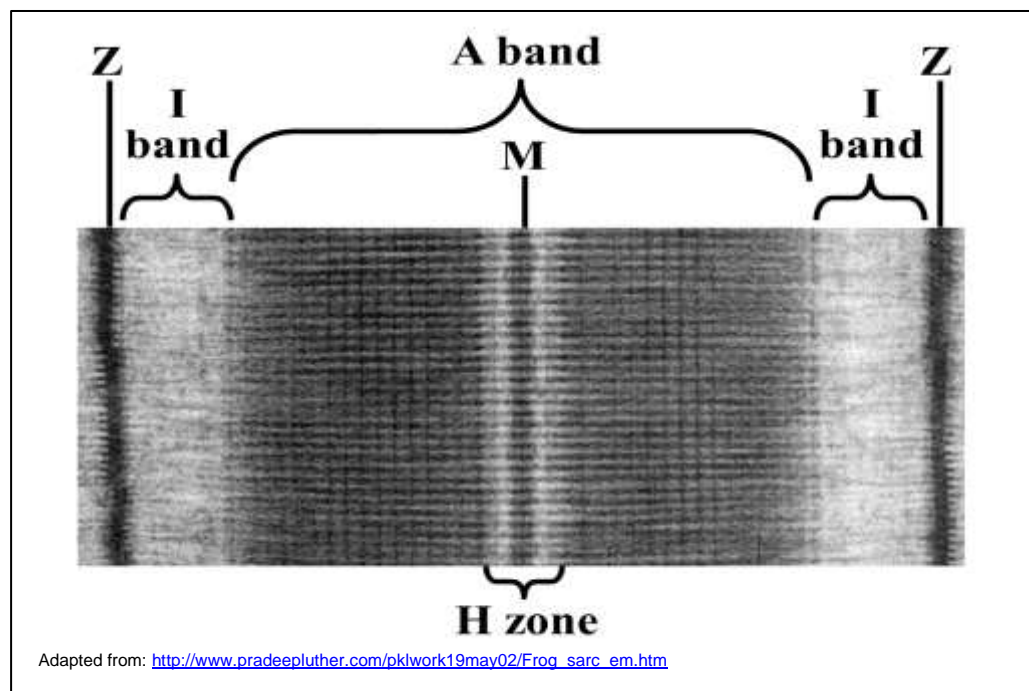

In this micrograph of a sarcomere from relaxed muscle, two **Z-lines** demarcate the sarcomere (Z for *zwischen*, German for 'between'). Thin (**actin**) filaments can be seen coming from the Z lines towards the myosin filaments which are thicker than the actin microfilaments. The region of the actin filaments are the I bands while the region of the thick **myosin** filaments makes up the A band, with an M line running down its center. The H zone includes the M line and the lighter region on either side of the M line. Electron micrographs of sarcomeres from relaxed and contracted skeletal muscle are shown below.

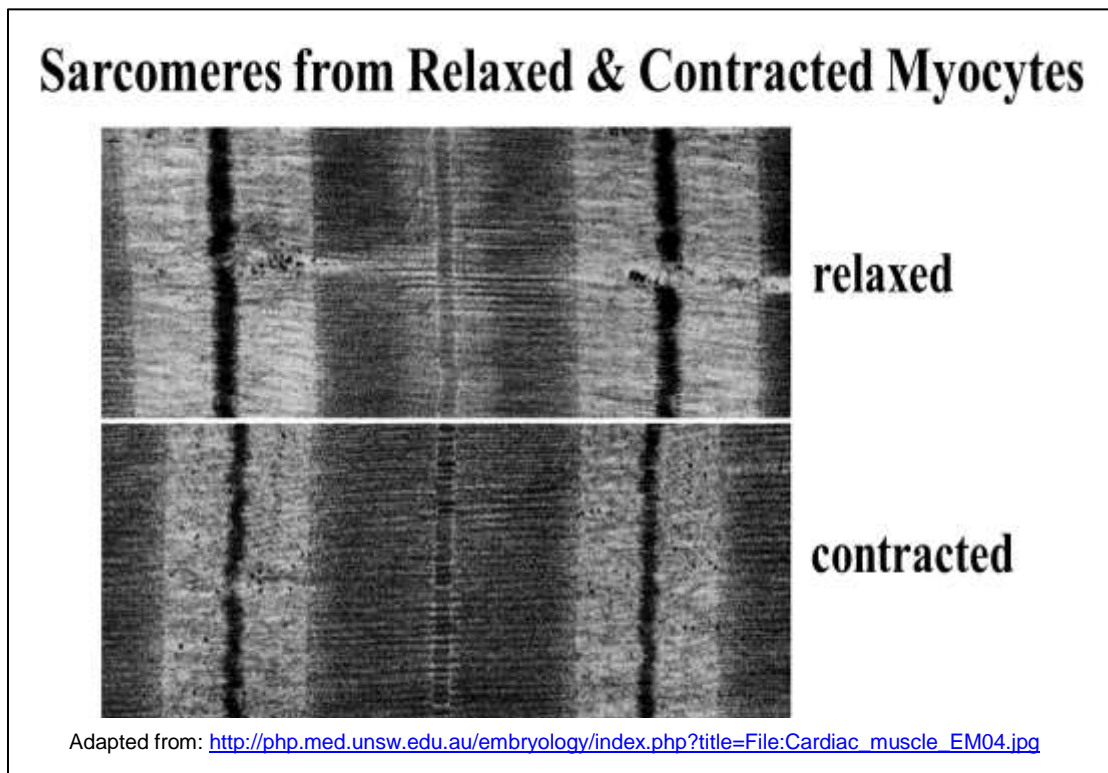

The micrographs show that the H zone has almost disappeared in the sarcomere of the contracted muscle cell. While the width of the A band has not changed, that of the I bands has decreased and the Z-lines are closer together after contraction. Given that the thin filaments are part of the I bands and the A band is composed mainly of thick filaments, the suggestion was that during contraction, the thin filaments slide along the thick filaments, drawing the Z-lines (to which they are attached) closer together. This was called the **sliding filament** hypothesis, or model of skeletal muscle contraction.

The sliding filament model is diagrammed below.

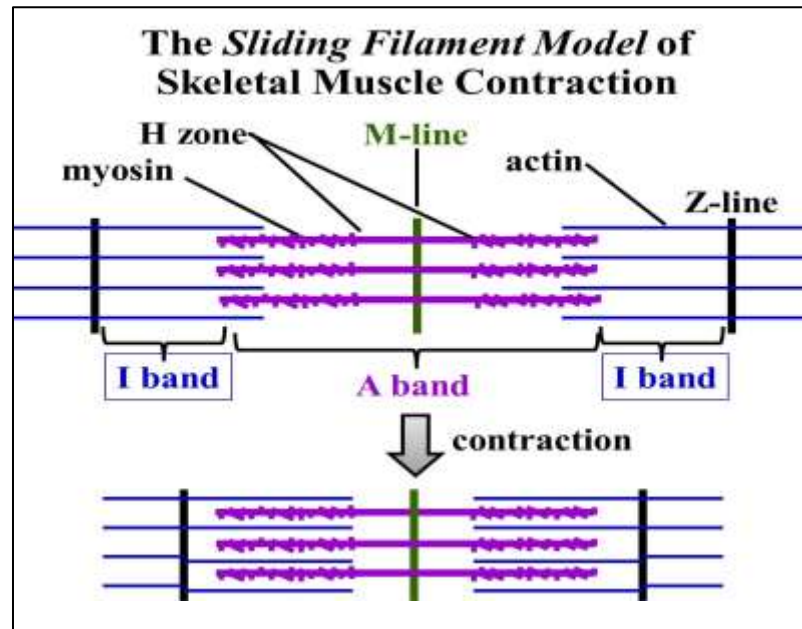

c. Actin-Myosin Interactions in Contraction

Recall the early purification of actomyosin components from skeletal muscle cells (above). After adding ATP, the separated components were examined in the electron microscope. Both thick (myosin) and thin (actin) filaments were recognized as separate entities that could be separated by centrifugation (as cartooned below).

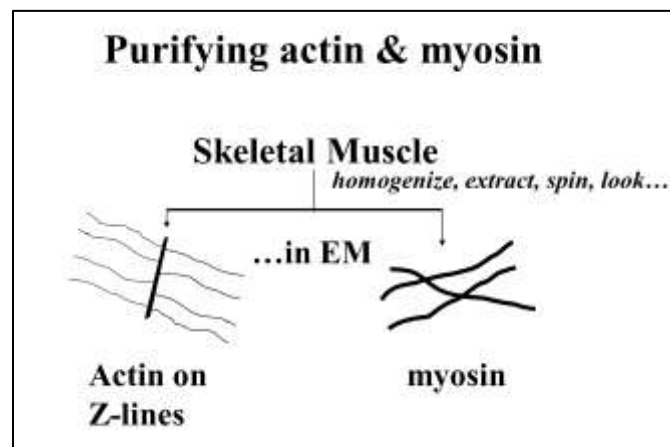

In these experiments, the actin was still attached to Z-lines.

Adding the 'purified' components back together actually reconstituted an actin-myosin complex that could also be seen in electron micrographs, as illustrated below.

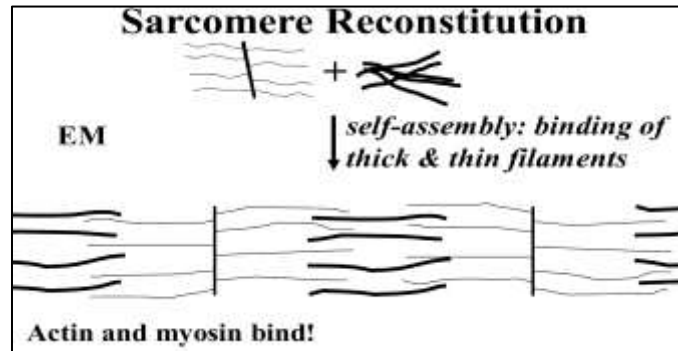

Remarkably, these *reconstituted sarcomeres* would “contract” to bring the Z-lines closer together, thereby confirming the sliding filament model of muscle contraction. An experimental demonstration of the role of ATP in this model is illustrated in the animation at <http://youtu.be/zsKhdjIAw8s>.

Thick and thin filaments could be further purified from these actinomyosin preparations and the thin actin filaments could be detached from the Z-lines. Myosin rods turned out to be a massive polymer formed primarily of ~599kD myosin monomers such as those shown below.

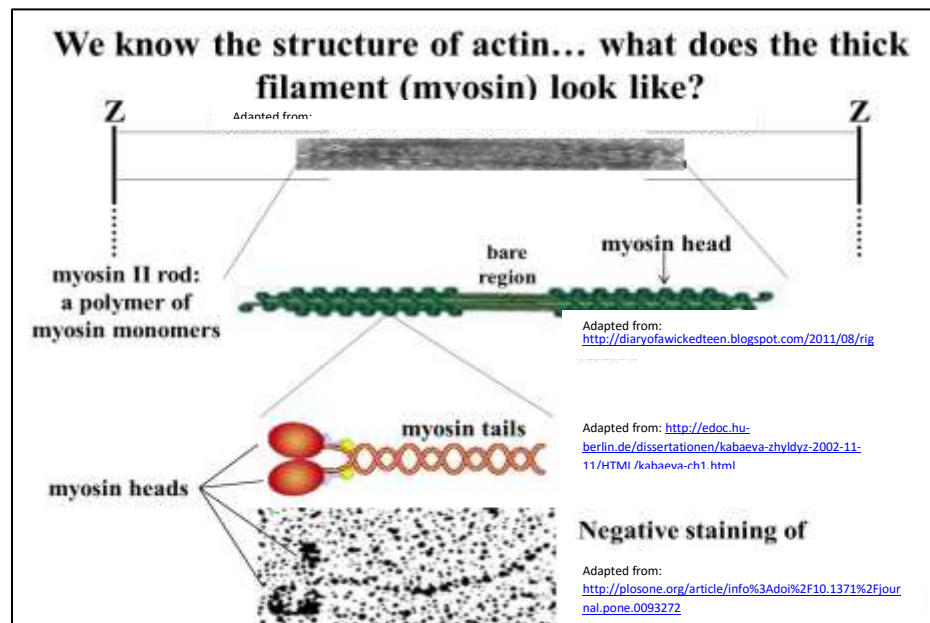

An early observation was isolated actin filaments had no ATPase activity. But while myosin preparations did have an ATPase activity, they would only catalyze ATP hydrolysis very slowly compared to muscle fibers. Faster ATP hydrolysis occurred only if the myosin filaments were mixed with microfilaments (on or off Z-lines).

In the electron microscope, isolated myosin protein monomers appeared to have head and tail regions. The monomers were shown to be composed of a pair of heavy chain and two pairs of light chain polypeptides (below).

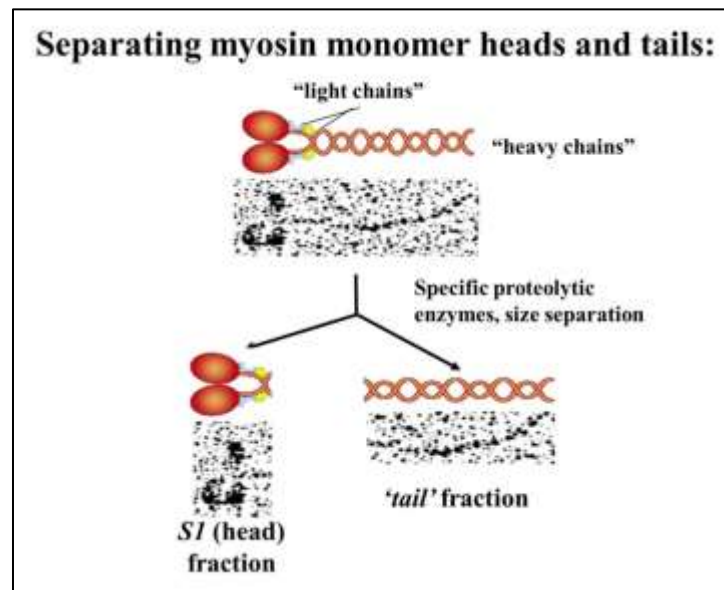

Treatment of monomers with certain proteolytic enzymes that hydrolyze peptide linkages only between specific amino acids was shown to 'break' peptide linkages within the heavy chains. The resulting **S1** and **tail** fragments could be separated by ultracentrifugation, examined in the electron microscope and assayed for ATPase activity. It turned out that the S1 fraction of myosin heads had a slow ATPase activity while the tails had none. The slow activity was not an artifact of isolation since if the S1 fraction was mixed with action filaments, the catalytic rate increased. The S1 fragments were then shown to also contain an action-binding domain.

CHALLENGE: What do you think is going on here? Why the faster catalytic rate when actin and myosin (or its parts) are mixed?

When actin filaments attached to Z-disks were mixed with S1 fragments the morphology of the actin changed dramatically: the microfilaments seem to have been **decorated** to have **arrowheads** along their lengths, as illustrated below.

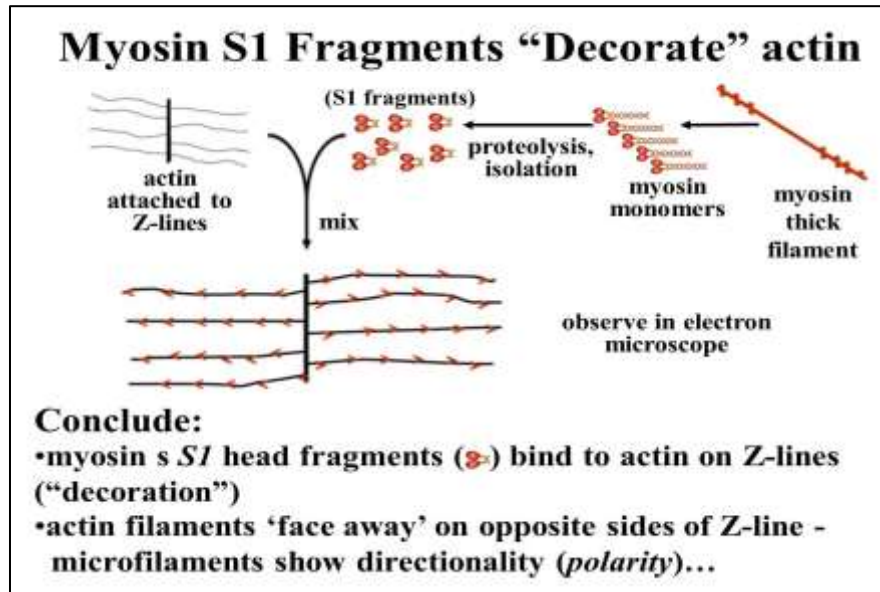

Intact myosin monomers would also bind to actin... with the same visual effect! As indicated in the drawing, the arrowheads *always* ‘point’ away from the Z-lines to which they are attached. The arrowhead-like binding of myosin to actin is consistent with the sliding filament model of contraction. A *bipolar* myosin pulls actin filaments towards each other from opposite sides of the myosin rods, thus drawing the Z-lines closer.

d. **Resolving the Actomyosin Contraction Paradox**

Whereas dynein and kinesin are motor proteins that ‘walk’ along microtubules, the myosin monomer is a motor protein that walks along microfilaments. In each case, these motor proteins are ATPases that use free energy of ATP hydrolysis to effect conformational changes that result in the walking, i.e., motility. In skeletal muscle, the myosin heads enable myosin rods to do the walking along F-actin filaments.

Electron microscope and other evidence supports a *sequence of allosteric changes* in which a myosin head bound to an actin monomer in the F-actin binds ATP, then dissociates from actin, then bends as if at a *hinge* as the

ATP is hydrolyzed, then binds to the “next” actin monomer in the microfilament, then bends back to its original configuration, releasing a molecule of ADP and remaining bound to the actin monomer. For an animation of these changes, see the link at http://youtu.be/CrB7A_DAK3I. If ATP is present after one of these events of *micro-sliding*, a second cycle sliding of actin along myosin can begin. Repetitive *micro-contraction cycles* involving myosin heads all along the thick filaments pull actin microfilaments projecting from opposite Z-lines, bringing the Z-lines closer to each other. The result is shortening of the sarcomere and ultimately of muscle cells and the entire muscle. A look at details of this *micro-contraction cycle* (below) will clarify not only the order of conformational changes in a myosin head, but will also resolve what began as a *contraction paradox*.

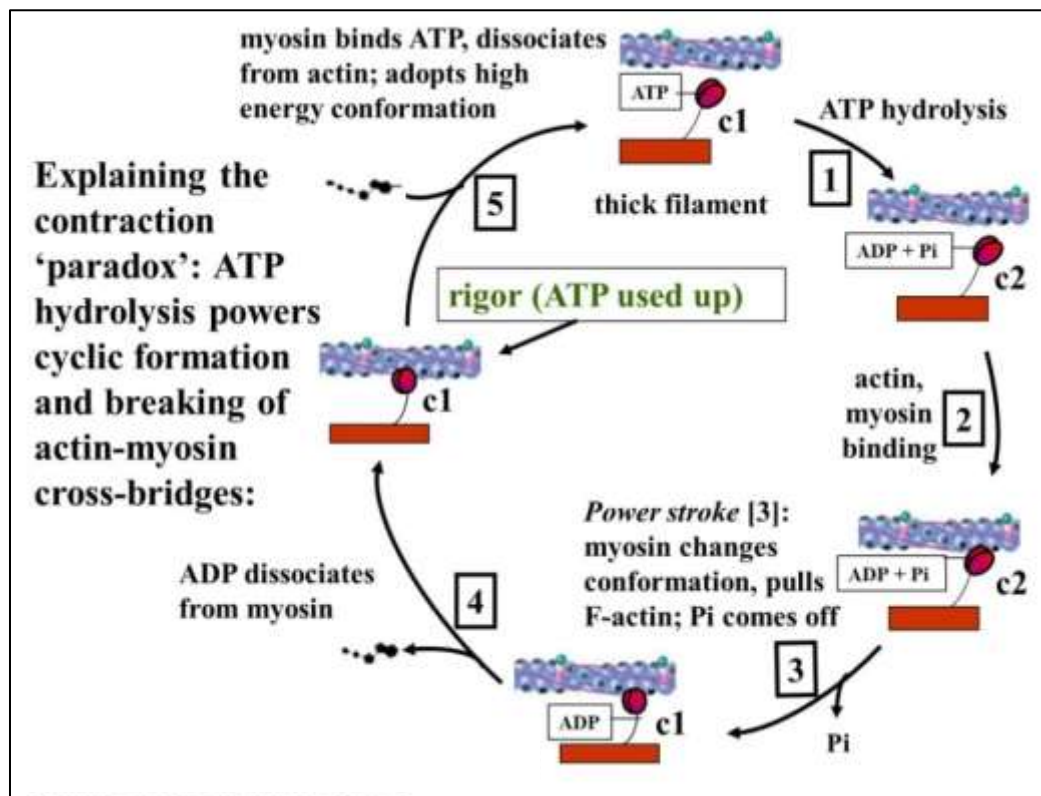

The myosin head micro-contraction cycle resolves the contraction paradox as follows:

- **ATP is necessary for muscle contraction:** When ATP is hydrolyzed myosin heads undergo a transition from a low energy conformation (c1) to a high energy conformation (step [1]). In this conformation, the myosin heads bind to actin monomers in the microfilament (step [2]).

- This binding results the **power stroke** (step [3]) in which ATP hydrolysis and an allosteric change in myosin (back to the c1 conformation) that pulls the actin along the myosin, in effect causing a micro-shortening of the sarcomere. Pi bound to the head after ATP hydrolysis is released during the power stroke.
- **ATP (but not its hydrolysis!) is necessary for muscle relaxation:** In step [4], the ADP still bound to the myosin head is released. In this state, the myosin head will remain bound to actin until ATP can again bind to the myosin head (step [5]), causing dissociation of myosin from actin, and starting the micro-contraction cycle again.

In the absence of ATP (as after the death of an organism), the micro-contraction cycle is interrupted as all myosin heads remain bound to the actin filaments in whatever the state of muscle contraction or relaxation (stretch) was at the time of death. This is **rigor mortis** at the molecular level. At the level of whole muscle, **rigor mortis** is seen in an inability to stretch or otherwise move body parts.

e. Regulating Skeletal Muscle Contraction

An action potential at a neuromuscular junction initiates contraction:

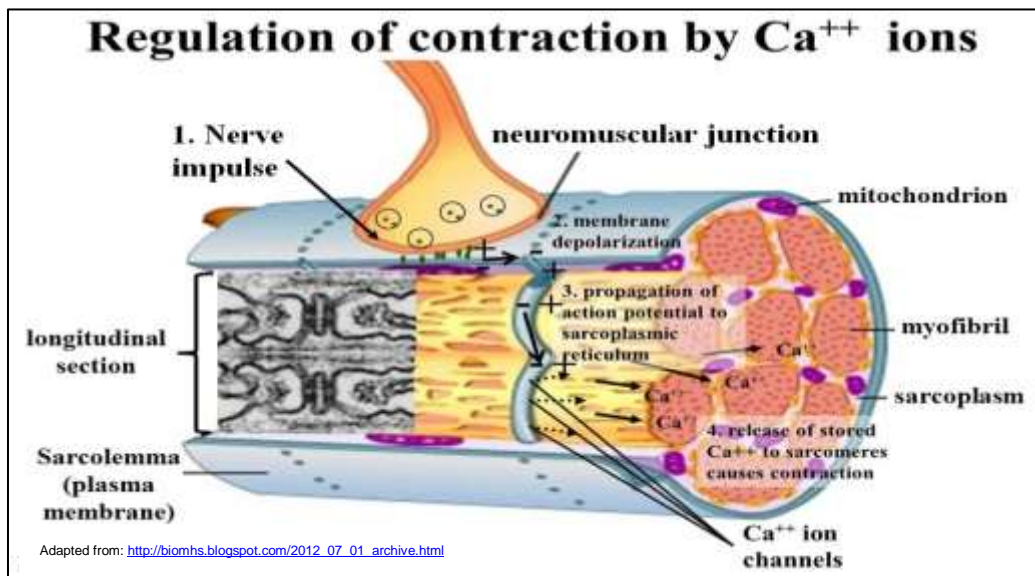

Typically, acetylcholine released by a motor neuron binds to receptors on muscle cells to initiate contraction. In early experiments, Ca^{++} was shown to be needed along with ATP to get glycerinated skeletal muscle to contract. It was subsequently demonstrated that Ca^{++} ions were stored in the smooth endoplasmic reticulum of muscle cells (or **sarcoplasmic reticulum**). As we have already seen, an action potential generated in the cell body of a neuron can be propagated along an axon to the nerve terminal, or synapse. In a similar fashion, an action potential generated at a neuromuscular junction travels along the sarcolemma to points where the sarcolemma is continuous with **transverse tubules (T-tubules)**. The action potential then moves along the T-tubules and then along the sarcoplasmic reticulum. This propagation of an action potential opens Ca^{++} channels in the sarcoplasmic reticulum. The Ca^{++} released bathes the sarcomeres of the myofibrils, allowing filaments to slide (i.e., contraction). This process is shown above and animated at this link: <http://youtu.be/HpZpA-vYDBU>.

The molecular basis of Ca^{++} ion regulation of muscle contraction involves 4 proteins that are bound to actin microfilaments in skeletal muscle. These proteins (three **tropomyosin** subunits and **tropomyosin**) are shown lying on actin in the illustration below.

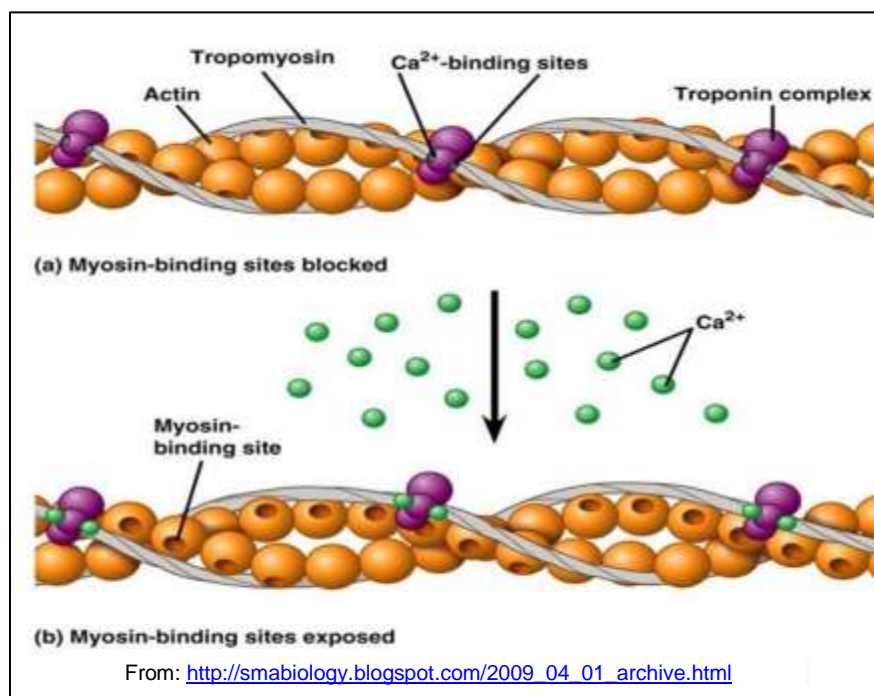

Ca^{++} ions bind to troponins along the actin filaments causing conformational changes in troponins and tropomyosin that expose myosin-binding sites on actin. Only then can ATP-bound myosin bind to actin and initiate the *micro-contraction cycle* illustrated earlier. The allosteric changes initiated by Ca^{++} binding are shown in greater detail in the drawing of an actin filament in cross-section, below.

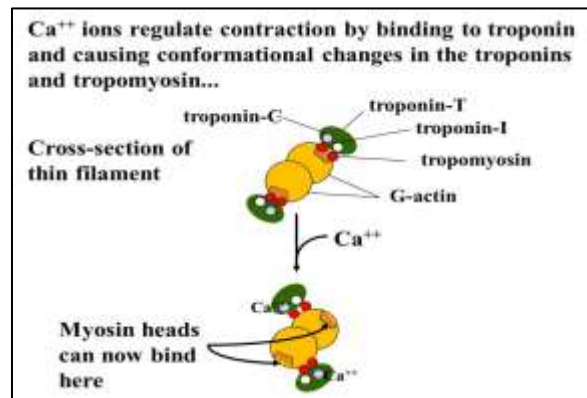

In resting muscle, tropomyosin (a fibrous protein) lies along the actin filament, covering up the myosin binding sites on seven G-actin subunits in the filament. In this conformation, **troponin T** (*tropomyosin-binding troponin*) and **troponin I** (*inhibitory troponin*) hold the tropomyosin in place. A chain reaction of conformational changes begins when Ca^{++} ions bind to **troponin-C** (*Ca⁺⁺-binding troponin*). The result is that tropomyosin shifts position along the filament to expose the myosin-binding sites on the G-actin subunits.

2. Muscle Contraction Generates Force

Contraction by ATP-powered sliding of thin along thick filaments generates force on the Z-lines (in 3 dimensions, these are actually **Z-disks**) to which the actin thin filaments are attached. The protein **α -actinin** in the Z-disks anchors the ends of the actin filaments to the disks so that when the filaments slide, the Z-disks are drawn closer, shortening the sarcomeres. Another Z-disk protein, **desmin**, is an intermediate filament organized around the periphery of Z-disks. Desmin connects multiple Z-disks in a myofibril. By keeping the Z-Disks in register, muscle cell, and ultimately, muscle contraction is coordinated.

Finally, for a muscle cell to shorten during contraction of myofibrils, the actin filaments at the ends of the cell must be connected to the cell membrane. Several proteins, including **syntrophins** and **dystrophin** (another intermediate filament protein) anchor the free ends of microfilaments coming from Z-disks to

the cell membrane. Still other proteins anchor the cell membrane in this region to the extracellular matrix (tendons) that are attached to bones! Force generated by myosin hydrolysis of ATP and the sliding of filaments in individual sarcomeres is thus transmitted to the ends of muscles to effect movement. If the name *dystrophin* sounds familiar, it should! The protein is named for a mutation that causes muscular dystrophy, characterized by progressive weakening of the muscles. Like many genes, the dystrophin gene gets its name from the malfunctions caused by its mutation.

3. Do Myosin Rods Just Float in the Sarcomere?

The answer as you might guess, is *no*; myosin rods are anchored to **M-line** proteins (e.g., *myomesin*, *obscurin*, *skelamin*). The functions of these proteins are not fully understood, but some if not all participate in keeping the myosin thick filaments in register in the sarcomere. This is similar to how Z-disks keep sarcomeres themselves in register by binding to the ends of actin filaments. But that's not all! As early as 1954, R. Natori realized that when contracted muscle relaxes, it is lengthened beyond its resting state, after which it shortens again to its resting length. He proposed that this elasticity must be due to a fiber in the sarcomere (<http://ir.iikei.ac.jp/bitstream/10328/3410/1/54-1-51.pdf>). Twenty five years later, the elastic structure was identified and called **titin**! At almost 4×10^6 Da, and 35,213 amino acids, the aptly named *titin* is the largest known protein. The gene for titin contains the largest number of exons (363). It is also the most abundant protein in muscle cells, after actin and myosin. In addition to its elastic properties, *titin* participates in positioning myosin rods the H zone of sarcomeres, as illustrated below.

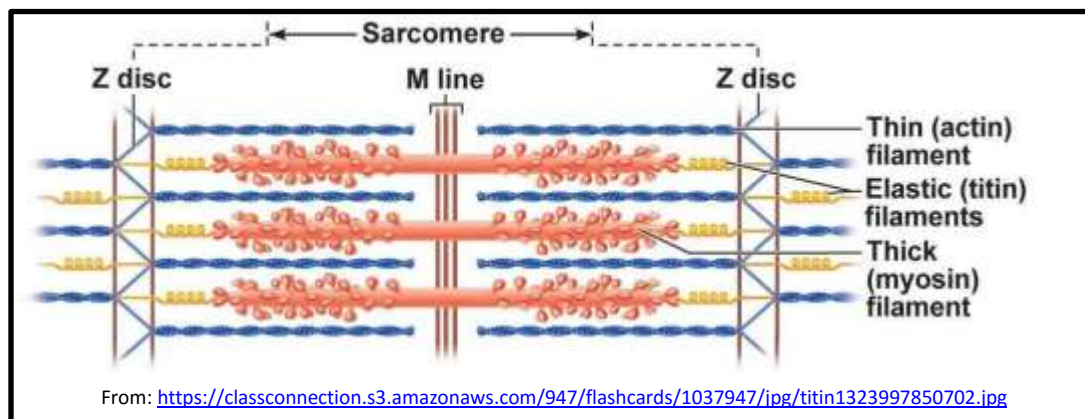

Titin's elastic features are shown as *coiled regions* that reach from the Z disc across the *I-band* to anchor myosin rods. **Titin** is anchored at Z-disks by binding to α -**actinin** and the protein **telethonin**.

But titin does not merely cross the *I-band* region of sarcomeres. It extends from the *Z-disk* all the way along the myosin rods to the *M-line* where it binds to **myosin-binding protein C (MYBPC3)** and **calmodulin (CALM1)**, among others. The reach of *titin* is shown in the illustration of a half-sarcomere below.

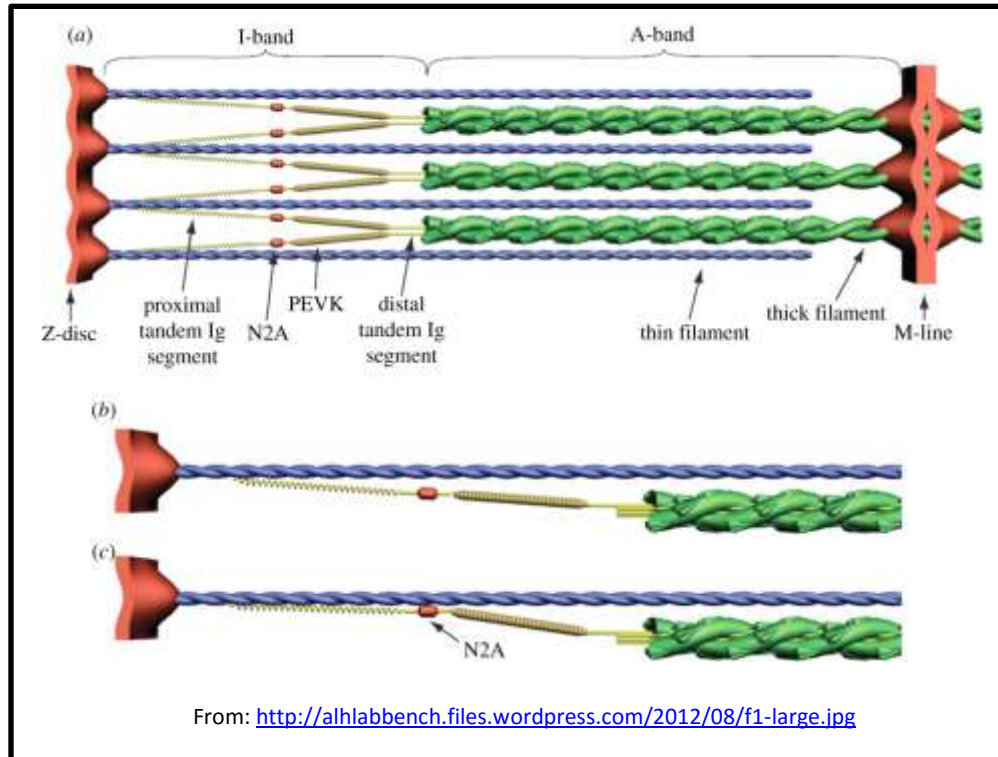

This giant, elongated protein has many domains. As shown panel (a) above, these include immunoglobulin (*Ig*) domains, **fibronectin** domains (not shown here), and the **PEVK** domain, among others. The **N2A** domain actually binds titin to actin near **Z-disks** (panels b, c).

Titin is over a micron long, functioning as a molecular spring. Its coiled domains compress during contraction, passively storing some of the energy of contraction. When skeletal muscle relaxes (Ca^{++} is withdrawn from the sarcomere, ATP displaces ADP from myosin heads and actin and myosin dissociate), the muscle stretches under the influence of gravity or an opposing set of muscles. But the connections of *titin* limit the stretching, while its 244 individually folded protein domains unfold, allowing a potentially overstretched muscle 'bounce' back to its normal relaxed length. How do we know that titin can stretch? In a particularly elegant experiment, antibodies were made to peptides (*N2A* and *I20-I22*) on either side of the **PEVK** domain of *titin*. The antibodies were attached to **nanogold** particles that are only

visible in an electron microscope. Longitudinal sections of *myofibers* stretched to different lengths were treated with the antibodies. The binding was detected as electron-dense (dark) nanogold particles to which they were attached, as shown below.

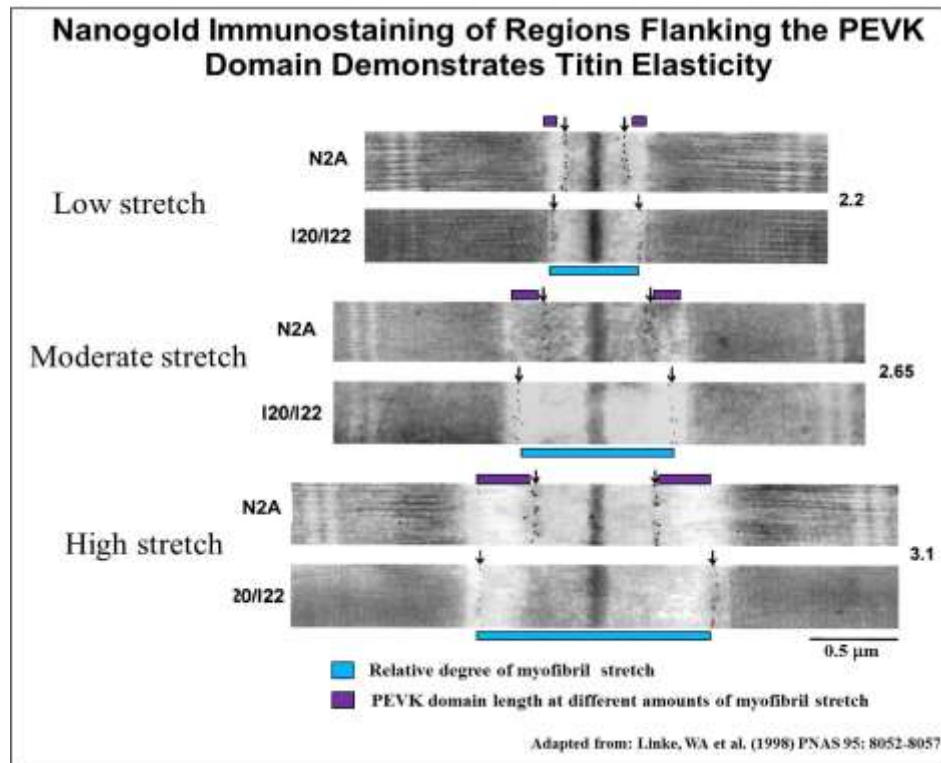

In the experiment, *myofibers* were treated separately with either the *N2A* or the *I20-122* antibodies. The relative 'stretch' is shown by numbers at the right and by the blue bars below the *myofibril pairs*. The elasticity of titin, and more specifically its PEVK domain, is demonstrated by the increasing distance between both the *N2A* and the *I20-122* antibody-nanogold particle arrays from the Z-disks (at the center of the image). This 'stretchability' of the PEVK domain is also highlighted by the increasing distance between the different antibodies shown by the length of the purple bars above each myofibril pair.

So not only are myosin rods tethered at either end to Z-disks M-lines by a hugely long elastic titin protein, but they are elastic. Apparently they store some of the free energy of contraction when they are compressed, and then passively release that energy during relaxation. Proteins in the M-line include myomesin, myosin-binding protein C, calmodulin 1, CAPN3, and MURF1; all of these can be shown to bind to titin. Specific roles for these and as yet unidentified proteins may yet be discovered, as soon as the right questions are asked!

4. Non-muscle Microfilaments

Electron microscopy revealed thin filaments in the cytoskeleton of eukaryotic cells. When myosin S1 heads placed atop electron micrograph thin sections were shown to *decorate* these microfilaments with arrowheads, it was clear that they were a form of F-actin. Decorated actin in the microfilament bundles of *microvilli* in the brush border of epithelial cells are shown below.

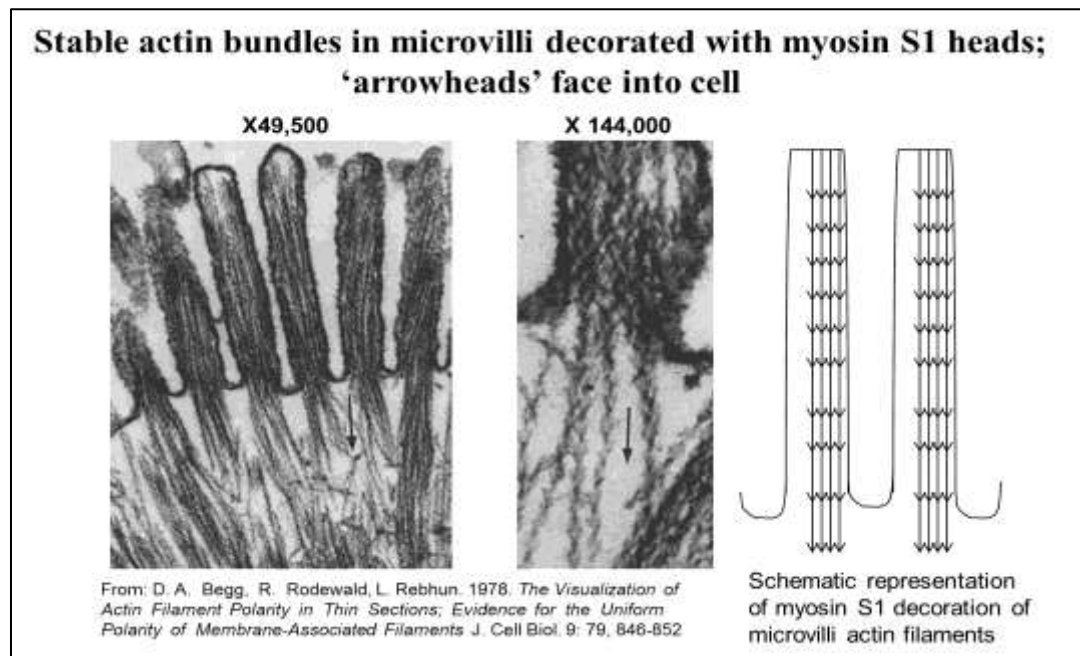

As we noted earlier, microfilaments give the cell shape and enable cell movement and cytoplasmic streaming inside cells. Here they strengthen microvilli and anchor them to the rest of the cell.

In other non-muscle cells, microfilaments typically lie in the cell cortex just under the plasma membrane where they support cell shape. In animal cells, these **cortical microfilaments** can be reorganized to change cell shape. A dramatic example of this occurs in dividing cells, during cytokinesis when the dividing cell forms a **cleavage furrow** in the middle of the cell. The cortical microfilaments pass each other with the help of **non-muscle myosin**, progressively pinching the cell until it divides into two new cells. The role of cortical filaments is animated at <http://youtu.be/LvDSi7xtYo>.

Other examples of microfilaments in cell motility include the ability of *amoeba* and other *phagocytic cells* to extend *pseudopodia* to engulf food or foreign particles (e.g., bacteria), respectively. Similarly, when fibroblast cells move along surfaces, they extend thin *filipodia* into the direction of movement by assembling actin bundles along the axis of cell movement (illustrated below).

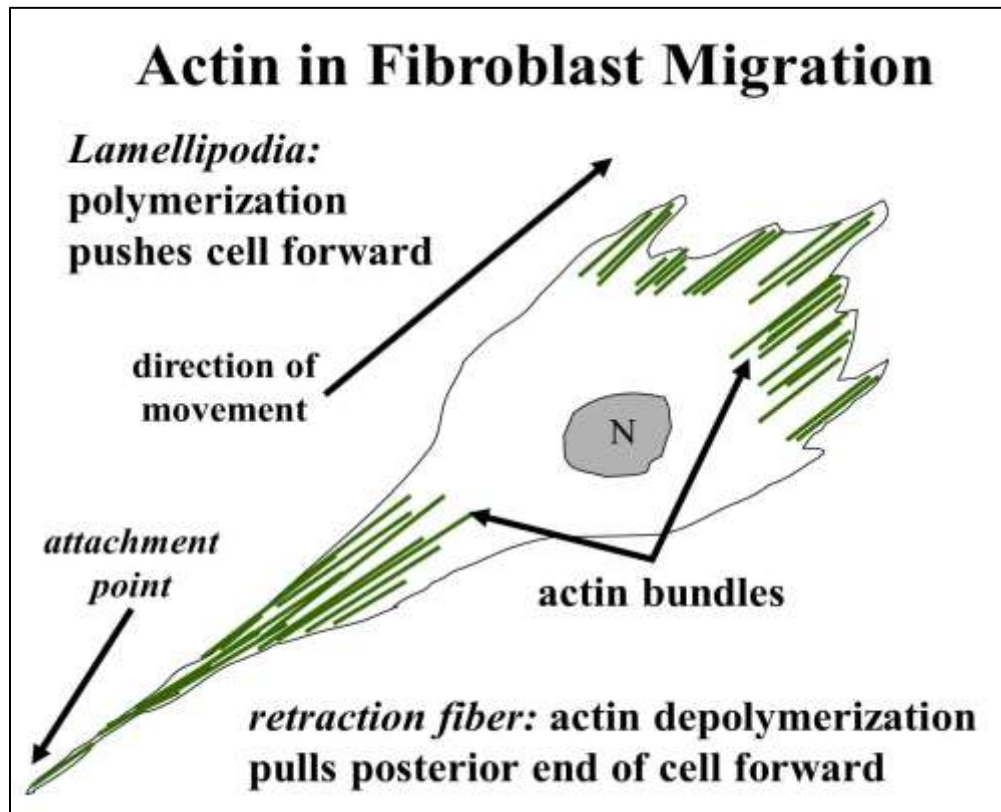

As we saw for microtubule-mediated cell motility, some actin-mediated motility may be primarily based on actin assembly and disassembly, as in the extension of filipodia at the moving front of a fibroblast. As the fibroblast moves forward, a *retraction fiber* at the hind-end of the cell remains attached to the surface (*substratum*) along which it is migrating. Eventually however, actin-myosin interactions (in fact, sliding) causes retraction of most of this 'fiber' back into the body of the cell.

While cytoplasmic streaming, which results in a balanced distribution of cellular components and nutrients throughout the cell, also involves actin-myosin interactions, the structures involved have been studied in stress fibers.

As you can see in the illustration below, thin and thick filaments (actin and myosin overlap and slide during movements of stress fibers.

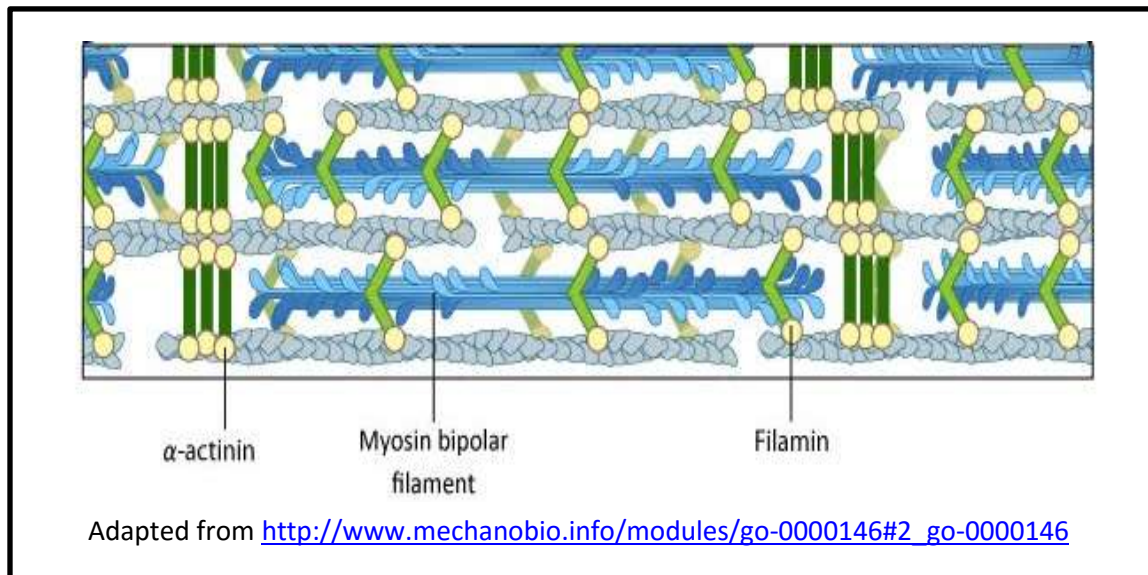

Filamin in this drawing is shown holding actin filaments together at an angle, while **α -actinin** also helps to bundle the actin (thin) filaments. **Titin** also seems to be associated with stress fibers. However, unlike highly organized skeletal muscle sarcomeres, these proteins and filaments in stress fibers are not part of a Z- or M-line superstructures. Could such less-organized non-muscle cell stress fiber filament bundles be the evolutionary predecessor to sarcomeres in muscle cells?

5. Actins and Myosins are Encoded by Large Gene Families

Like actin, myosin has been found in virtually every cell type. Myosins are not the same protein in all cells, and their genes comprise a large *gene family*, each gene encoding a different myosin **isoform**. Some of these genes express myosin isoforms that perform specific motility functions in the cells where they are expressed. Unique functions have not been identified for other isoforms. Despite this diversity of isoforms and amino acid sequences, all myosins have an ATPase function, and a myosin from one species can decorate the actin filaments of another species, even across wide phylogenetic distances.

Actin genes also comprise a large gene family, and while some actin genes are expressed in a cell-specific manner, the physiological advantages of a cell containing one and not another kind of actin are generally unclear.

D. *Intermediate Filaments – an Overview*

Once formed, the 10 nm diameter intermediate filaments are more rigid and more stable than actin filaments or microtubules. They are a family of proteins related to **keratin**, the common extracellular protein of hair and fingernails. As proteins, they do not readily fold into tertiary structures, but remain elongated; their secondary structure accounts for their relatively low solubility and rigidity. In cells, they permeate the cytosol where they function to maintain cell shape. As we have just seen, they also anchor cells to other cells (recall their role in cell junctions) and thereby provide tensile strength to tissues. Finally, **lamins** are intermediate filaments that make up structural elements of the *nuclear lamina*, a kind of **nucleoskeleton**.

As we saw earlier, intermediate filament subunits have a common structure consisting of a pair of monomers, each with globular domains at their C- and N-terminal ends. The basic unit of intermediate filament structure is a dimer of these monomers, with a coiled rod separating the pairs of globular heads. These dimers further aggregate to form larger filaments that, unlike microfilaments and microtubules, are non-polar. They lack ATPase activity and can be disassembled as needed when cells change shape. A unique property of intermediate filaments is that they are flexible rods that can be stretched, so that they can allow actins and microtubules a degree of freedom of movement of and within cells.

In addition to a role in helping to maintain cell shape, we have already seen intermediate filaments as part of desmosomes that generally bind cells firmly together, and in muscle cells anchoring actin to either Z-disks or the plasma membrane. Thus, while not participating in capturing the energy needed for cell motility, intermediate filaments nonetheless have a major role in transducing the energy into a motile force. And of course, intermediate filaments make up many extracellular structures, from fur and hair to feathers to toenails and fingernails.

CHALLENGE: How many intermediate filaments can you identify by name and function?

Some iText & VOP Key Words and Terms

"9+2"	F-actin	myosin ATPase
α tubulin	F-actin polarity	myosin
A-band	flagella	myosin "heads"
acetylcholine	fluorescence microscopy	neuromuscular junction
acidic keratin	force transduction	nuclear lamina
actin	G-actin	plus and minus ends
actin-binding proteins	hair, horn	protofilaments
actin-myosin interactions	I-band	pseudopodia
actin-myosin paradox	intermediate filaments	sarcomere
action potential	intestinal microvilli	sarcoplasmic reticulum
amoeboid movement	keratin	sarcolemma
ATPase	keratin isoforms	scales, feathers, fingernails
axoneme	lamins	secretion vesicle transport
β tubulin	membrane depolarization	skeletal muscle contraction
basal body	microfilaments	skeletal muscle relaxation
basic keratin	microtubule assembly end	sliding filament model
Ca ⁺⁺ regulation of contraction	microtubule disassembly end	syncytium
Ca ⁺⁺ release v. active transport	microtubule doublets	thick and thin filaments
cell motility	microtubule organizing center	titin
centriole	microtubule polarity	transverse (T) tubules
cilia	microtubule-associated proteins	<i>treadmilling</i>
contraction regulation	microtubules	tropomyosin
cortical cellular microfilaments	mitotic, meiotic spindle fibers	troponin I
creatine phosphate	M-line	troponin T
cross-bridges	motor proteins	troponins

cytoplasmic streaming	MTOC	troponin C
cytoskeleton	muscle cell	tubulin heterodimer
desmosomes	muscle fiber	tubulins
dynein	myocyte	Z-disks
evolution of actin genes	myofiber	Z-line
evolution of myosin genes	myofibril	

Chapter 17: Cell Division and the Cell Cycle

Separation of replication from cell division in eukaryotes; cell cycle checkpoints, cyclins and MPF, cell death, cancer

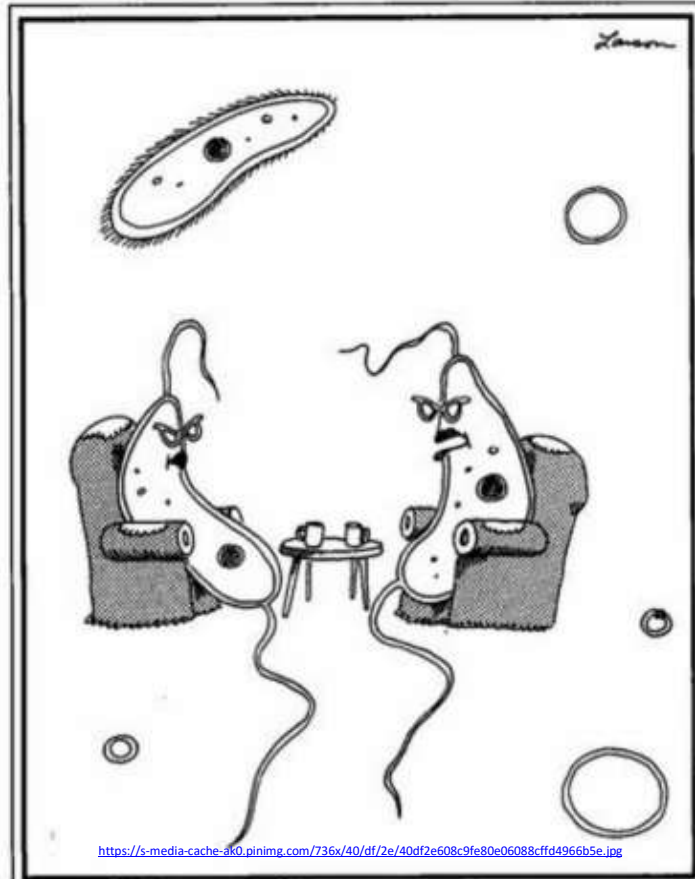

"He told you that? Well, he's pulling your flagellum, Nancy."

I. Introduction

It will be helpful here to review *mitosis* and *cytokinesis* since these parts of the cell cycle will be noted but not covered in detail here. Mitosis is divided into 4-5 phases (depending on whose text you are reading!). Mitosis and cytokinesis last about 1-1.5 hours in the life of a cell. The rest of the time (typically 16-20 hours) was called *interphase* because 19th century microscopists saw nothing happening in cells when they were not in mitosis or actually dividing. It was not until the 1970s that interphase events began to be described. Experiments then revealed that interphase, like mitosis, is divided into phases: G1, S and G2. Thus cellular life is defined by the sequence of *Mitosis*>*Cytokinesis*>*G1*>*S*>*G2*>...

We soon discovered that progress through the cell cycle is generally regulated by *protein phosphorylations* catalyzed by **kinases**. The early experiments lead to the discovery of *mitosis-promoting factor (MPF)*, one of these kinases. Kinase-regulated events are *checkpoints* that cells must pass through in order to enter the next step in the cell cycle. As you might guess, the failure of a checkpoint can have serious consequences, notably *carcinogenesis*, the runaway proliferation of cancer cells. As we consider the fate of differentiating cells, we'll also look at some molecular details of cellular end-of-life, or **apoptosis** (also called *programed cell death*).

Voice-Over PowerPoint Presentations

[Cell Division: Discovery of the Cell Cycle](#)

[Cell Division: Cyclins, MPF, Apoptosis, Cell Cycle Checkpoints](#)

Learning Objectives

When you have mastered the information in this chapter and the associated VOPs, you should be able to:

1. describe the *phases of the cell cycle* and what occurs in each
2. interpret experiments leading to our understanding the *separation of chromosomal events from duplication of the DNA* contained in those chromosomes.
3. describe the role of *cyclin* and *cdk* (cyclin-dependent kinases) in MPF
4. compare the roles of different cyclins and cdks in regulating progress through the cell cycle
5. Define cell-cycle checkpoints that monitor cell cycle activities
6. Explain the molecular interactions between DNA damage, cell cycle checkpoints (arrest of the cell cycle if vital activities are blocked) and apoptosis
7. formulate hypothesis to explain what mistakes of cell cycling might *transform* a normal cell into a *cancer* cell
8. suggest examples of *apoptosis* in insects and humans
9. compare and contrast examples of apoptosis and *necrosis*
10. formulate an hypothesis to account for the degradation of cyclin after mitosis
11. research and explain how different chemotherapeutic agents work and how they achieve their side effects

II. Overview of the Cell Cycle

The life of actively growing bacteria is not separated into a time for duplicating genes (i.e., DNA synthesis) and a time for **binary fission** (dividing and partitioning the new DNA into new cells). Instead, the single circular chromosome of a typical bacterium is already replicating even before cell division is complete, so that the new daughter cells already contained partially duplicated chromosomes.

Cell growth, replication and fission are illustrated below.

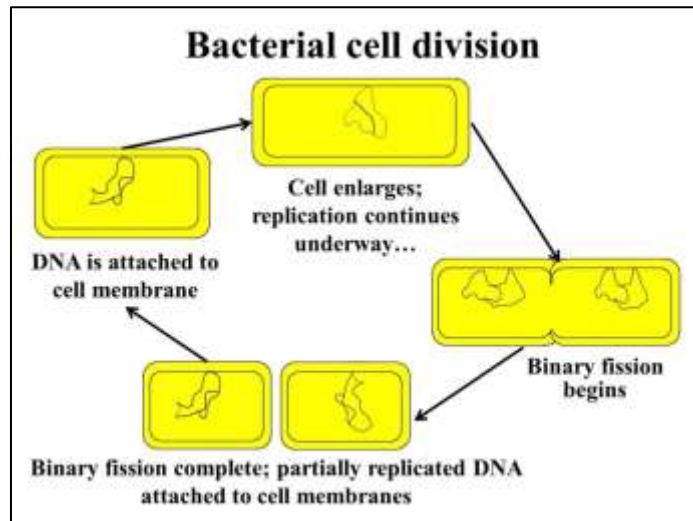

The roughly 30-60 minute life of an actively growing bacterium **is not** divided into a cycle with discrete phases. On the other hand, typical eukaryotic cells have a roughly 16-24 hour cell cycle divided into four separate phases. In the late 1800s, light microscope observations revealed that some cells lost their nuclei and formed **chromosomes** (from *chroma*, colored; *soma*, bodies). Paired, attached chromosomes (chromatids) were seen to separate and to be drawn along spindle fibers to opposite poles of dividing cells. Thus homologous chromosomes were equally partitioned to the daughter cells at the end of cell division. Because of the ubiquity of this process of **mitosis**, chromosomes were soon described as being the stuff of inheritance, the carrier of genes! The short period of intense activity was in stark contrast to the much longer 'quiet' time in the life of the cell, called **interphase**. The events of mitosis itself were described as occurring in 4 phases, as shown below.

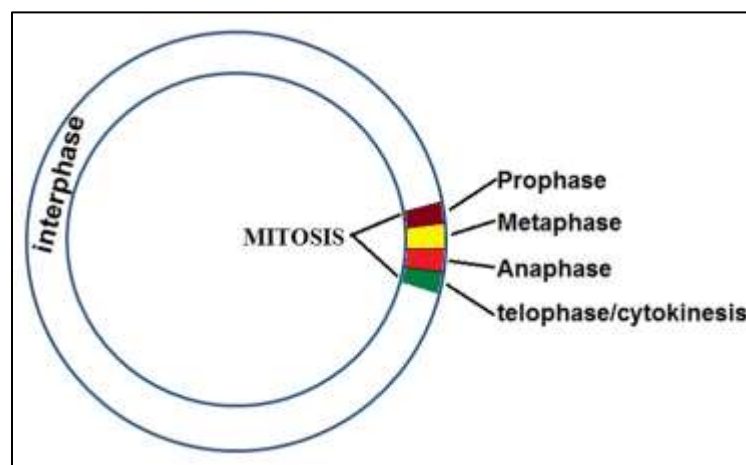

Depending on whom you ask, **cytokinesis** (the cell movements of actually dividing a cell in two) is *not* part of mitosis. In that sense we can think of three stages in the life of a cell: interphase, mitosis and cytokinesis. Of course, it turned out that interphase is not cellular 'quiet time' at all!

A. Defining the Phases of the Cell Cycle

The first clue that the formation of chromosomes was not the same as the replication of DNA came from the following experiment:

1. Cultured cells were incubated with ^3H -thymine, the base that would be used by the cell to synthesize the nucleotide thymidine.
2. After a short period of exposure to the ^3H -thymine, the cells are expected to make radioactive thymidine triphosphate (dTTP) and then radioactive DNA. The cells are then fixed for microscopy spread on a glass slide.
3. Autoradiography of the slides will show which of the cells on the slide had made radiolabeled dTTP nucleotide and incorporated it into DNA.
4. After the exposure, the excess ^3H -thymine was washed away and a piece of film was placed over the slide. Any radioactive molecules remaining in the cells should expose spots on the film where cells have made radioactive DNA.
5. When the film is developed, the spots should become visible.

This experiment and its results are illustrated below.

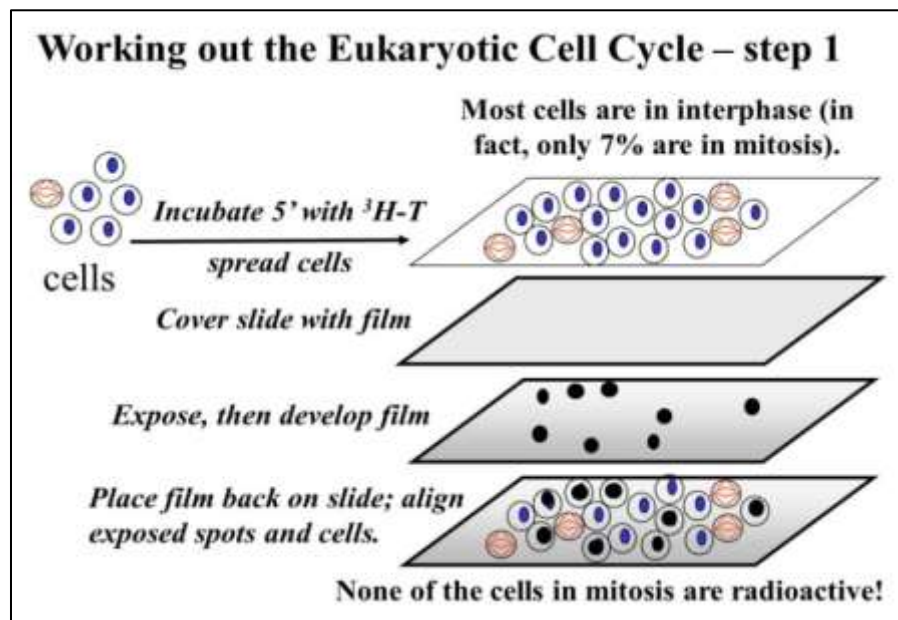

Observation of the autoradiographs showed that none of the cells in mitosis were radioactively labeled. The conclusion was that DNA is not synthesized during mitosis and that therefore, DNA synthesis must take place sometime in interphase (before mitosis and cytokinesis (below)).

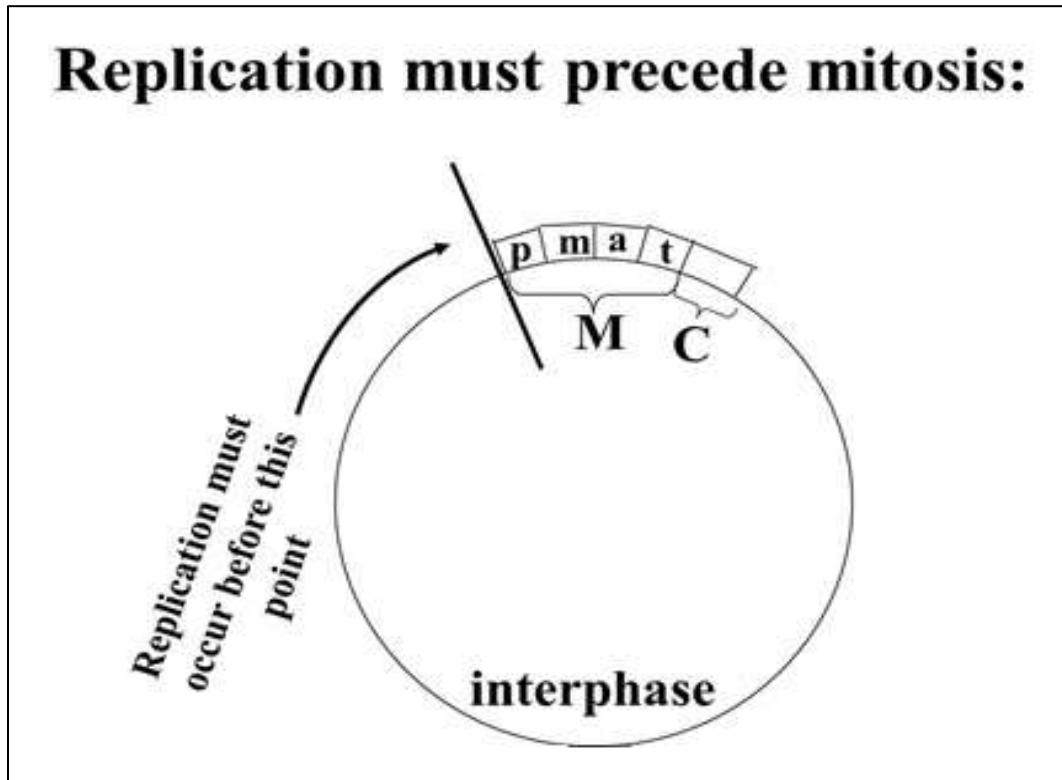

Next a series of **pulse-chase** experiments were done in which cells were exposed to ^3H -thymine for a short time and then allowed to grow in non-radioactive medium for different times thereafter before being prepared for autoradiography. Autoradiographs of cells at these different '**chase**' times were analyzed and three different phases were identified within interphase: Gap1 (G1), a time of DNA synthesis (S) and Gap 2 (G2). Here are the details of these very creative experiments (performed before it became possible to synchronize cells in culture so that they would all be growing and dividing at the same time).

1. Cells were exposed to ^3H -thymine for just 5 minutes (the **pulse**) and then centrifuged. The radioactive supernatant was then discarded
2. The cells were rinsed and centrifuged again to remove as much labeled precursor as possible.
3. The cells were re-suspended in fresh medium containing unlabeled (i.e., non-radioactive) thymine and incubated for different times thereafter (the **chase** periods).

4. After overlaying the slides with X-ray film, exposing and developing the film, the autoradiographs were examined.
- a) After a 3 hour (or less) chase period, the slides looked just like they would immediately after the pulse. That is, many *interphase* cells showed labeled nuclei, but cells in *mitosis* were not labeled (below).

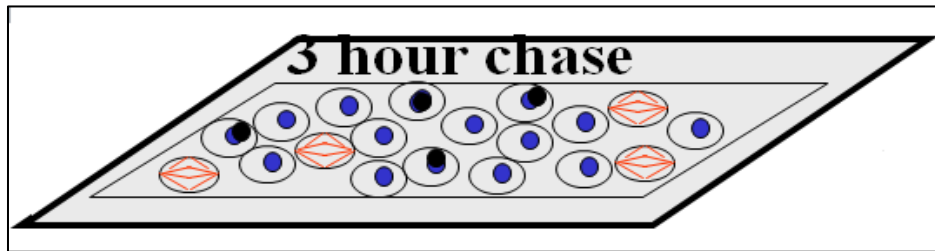

- b) After 4 hours of chase, a few cells in mitosis were labeled, along with others in interphase (below).

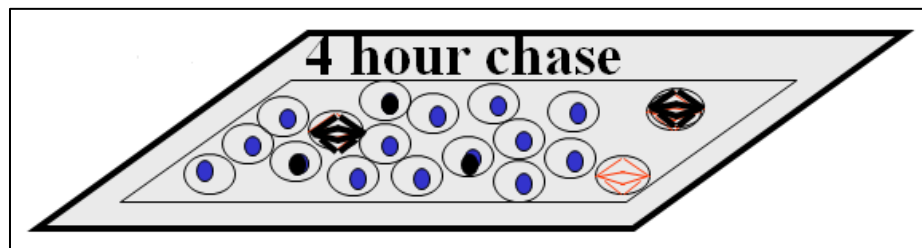

- c) After a 5 hour chase, most of the cells in mitosis (still about 7% of the cells on the slide) were labeled (below).

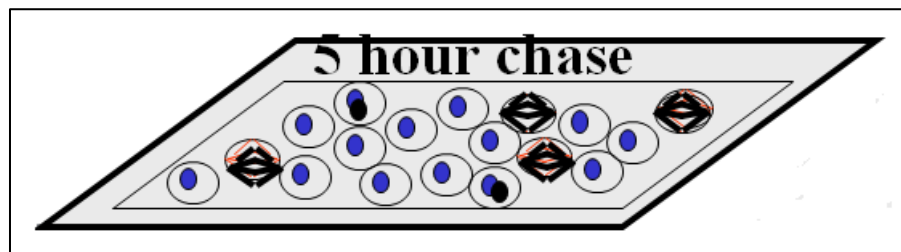

CHALLENGE: Here is a question to ponder: in these illustrations, the way the radioactive labeling is depicted is not exactly correct. Can you see the 'error' and explain what you would really see?

- d) After a 20 hour chase, while 7% of cells were in mitosis (as on all slides in this experiment), none were labeled. All of the labeled cells were in interphase (below).

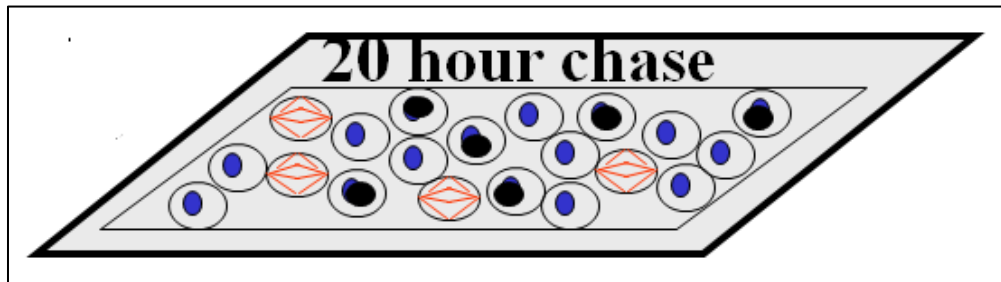

5. Radiolabeled mitotic cells were counted at each chase time and plotted against chase times as shown below.

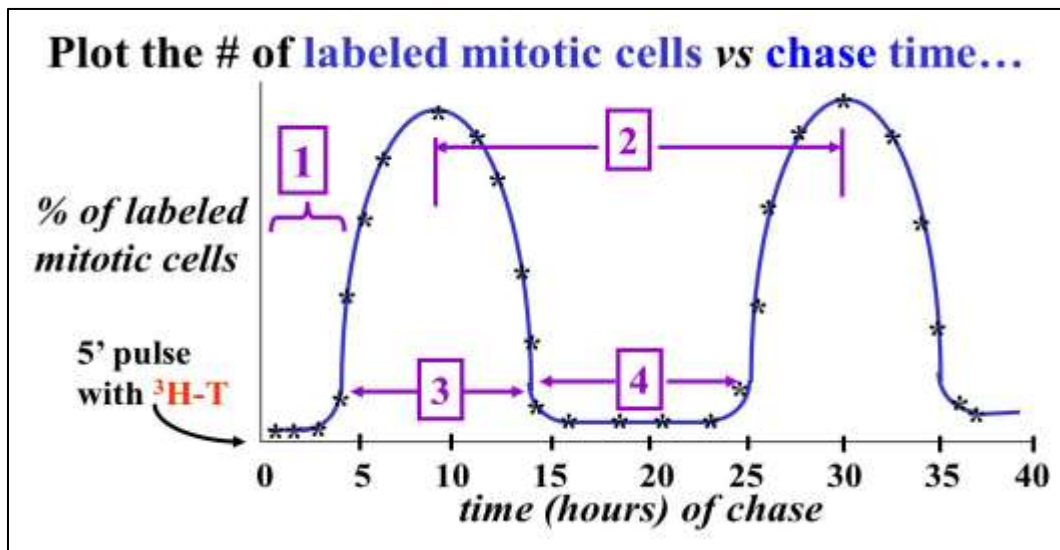

The duration of several events or time intervals in the cell cycle can be defined from the graph:

- Period #1 is the time between the end of DNA synthesis & the start of mitosis (called **gap 2**, or **G2**).
- Independent measurements of cell doubling time are easily done by spreading cells sampled at different times from the same culture on glass slides and counting them over time in the light microscope. For the cells in this experiment, the cell doubling time was ~20 hours, consistent with time period #2, the roughly 20 hours between successive peaks in the number of radiolabeled mitotic cells after the pulse.

- c) Time period #3 is easy enough to define. It must be the time from the start to the end of the time when DNA is synthesized, defined as the 'synthesis, or **S phase**.
- d) One period of the cell cycle remains to be defined. That's the time between the end cell division (i.e., mitosis and cytokinesis) and the beginning of DNA synthesis (replication). That time is **Gap 1**, or **G1**, which is calculated as the duration of the cell cycle (~20 hours) less the other defined periods of the cycle, as measured from the graph.

CHALLENGE: So what then is *interval 4* on the graph? Think about it and try to explain this roughly 9-10 hour period.

So, at last, here is our cell cycle with a summary of events known to occur in each phase.

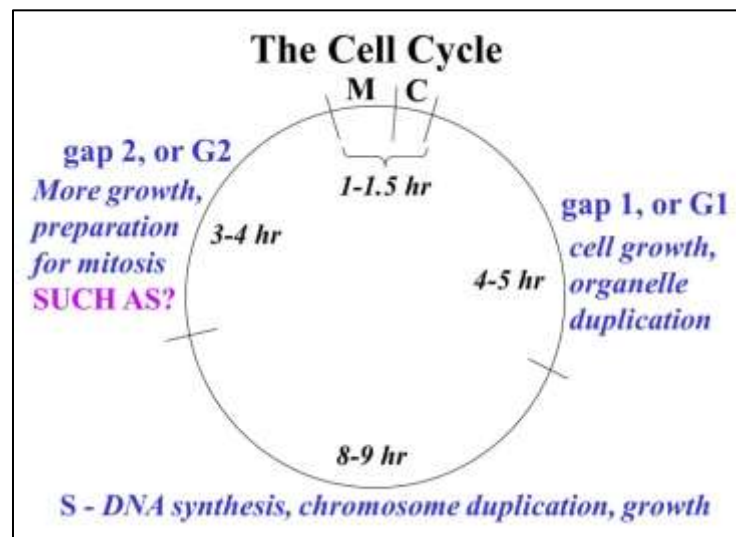

During all of interphase, the cell grows in size, in preparation for the next cell division. Growth in G1 includes the synthesis of enzymes and other proteins that will be needed for replication.

CHALLENGE: Review and name some of these proteins!

DNA is replicated during the S phase, along with the synthesis of new histone and other proteins that will be needed to assemble new chromatin. G2 is the shortest time of interphase and is largely devoted to preparing the cell for the next round of mitosis and

cytokinesis. Among the proteins whose synthesis increases in this time are the *tubulins* and proteins responsible for condensing chromatin into the paired chromatids representing the duplicated chromosomes. **Cohesin** is a relatively recent example of a protein made in the run-up to mitosis. It holds centromeres of chromatids together until they are ready to separate.

In a final note, typical dividing cells have generation times ranging from 16 to 24 hours. But some cells, like newly fertilized eggs might divide every hour or so. So events that normally take many hours may have to be completed in fractions of an hour.

CHALLENGE: How would you imagine a shortened cell cycle would look? How would events that normally take a longer time occur in a much shorter time?

B. When cells stop dividing...

Cells that are terminally differentiated are those that will spend the rest of their lives performing a specific function. These cells no longer cycle. Instead, shortly after entering G1 they enter a phase called G0 (below).

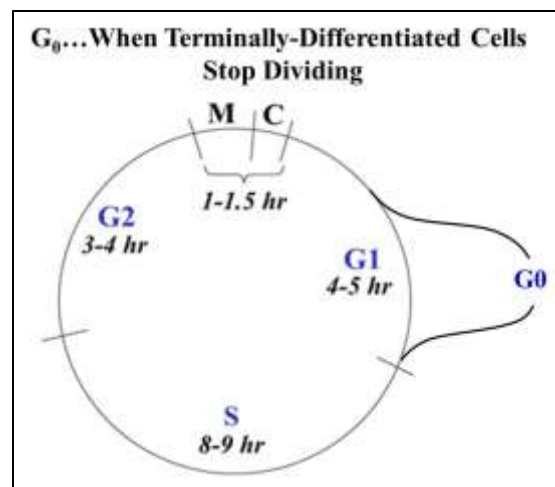

Referred to as **terminally differentiated**, these cells will normally never divide again. With a few exceptions (e.g., many neurons), most terminally differentiated cells have a finite lifespan, and if necessary will be replaced by stem cells. Examples include red blood cells; with a half-life of about 60 days, they are regularly replaced by reticulocytes produced in bone marrow.

III. Regulation of the Cell Cycle

Progress through the cell cycle is regulated. The cycle can be controlled or put on 'pause' at any one of several phase transitions, or **checkpoints** that monitor whether the cell is on track to a successful cell division event. Superimposed on these controls are signals that promote cell differentiation. *Embryonic cells differentiate* as the embryo develops. Even after *terminal differentiation* of cells that form all adult tissues and organs, *adult stem cells* will divide and differentiate to replace worn out cells. Cells that have fully differentiated are typically signaled in G1 to stop cycling and enter G₀. In some circumstances cells in G₀ are recruited to resume cycling. If this occurs to normal cells in error, the cells may be transformed to cancer cells. Here we consider how the transition between phases of the cell cycle is controlled.

A. Discovery and Characterization of *Maturation Promoting Factor (MPF)*

In this sense, growing, dividing cells are monitoring their own progress through the phases. Cells produce internal chemical signals that let them *know* when it's time to begin DNA replication or mitosis or even to enter from G₁ into G₀ when they reach the terminally differentiated state. The first demonstration that a dividing cell produces such a chemical involved asking what prompts a quiescent frog oocyte to divide and produce an egg ready to be fertilized. The experiment, possible because amphibian oocytes and eggs are large cells, is summarized below.

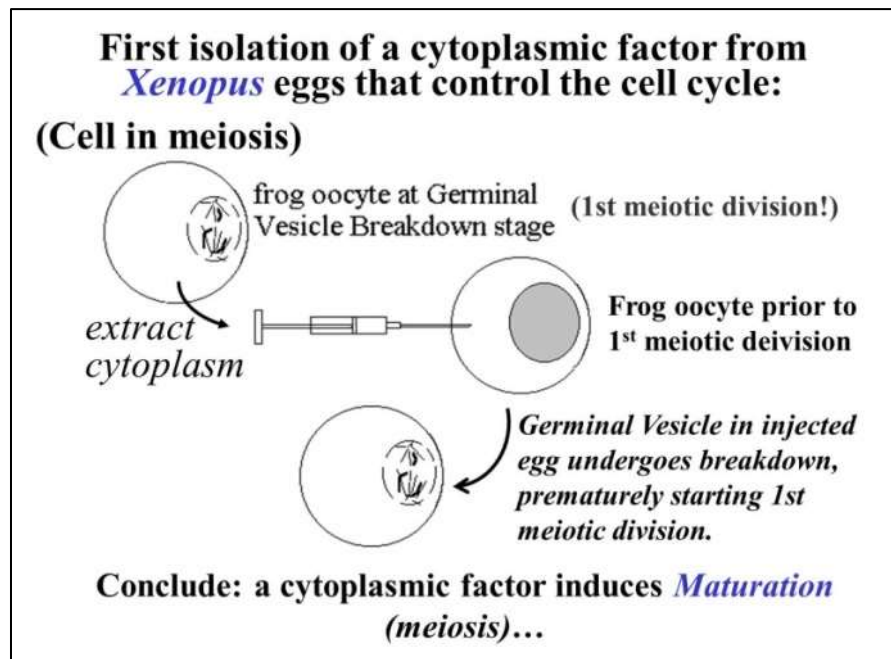

In this experiment, the hypothesis was that the cytoplasm of a frog oocyte in the middle of meiosis must contain a chemical factor that caused the cell to lose its nuclear membrane, condense its chromatin into chromosomes and enter meiosis. Using a fine hypodermic needle, cytoplasm was withdrawn from these large oocytes in the *germinal vesicle breakdown* stage, i.e., in the midst of the first meiotic division.

When this cytoplasm was transferred by injection into an oocyte not yet in meiosis, the cell proceeded to enter meiosis prematurely. Clearly mature meiotic oocyte cytoplasm contains a chemical factor that could be transferred from one cell to another, inducing it to undergo meiosis. This chemical, called **maturation promoting factor (MPF)** was isolated and purified from meiotic cells. When injected into pre-meiotic cells, purified MPF caused them to enter meiosis (below).

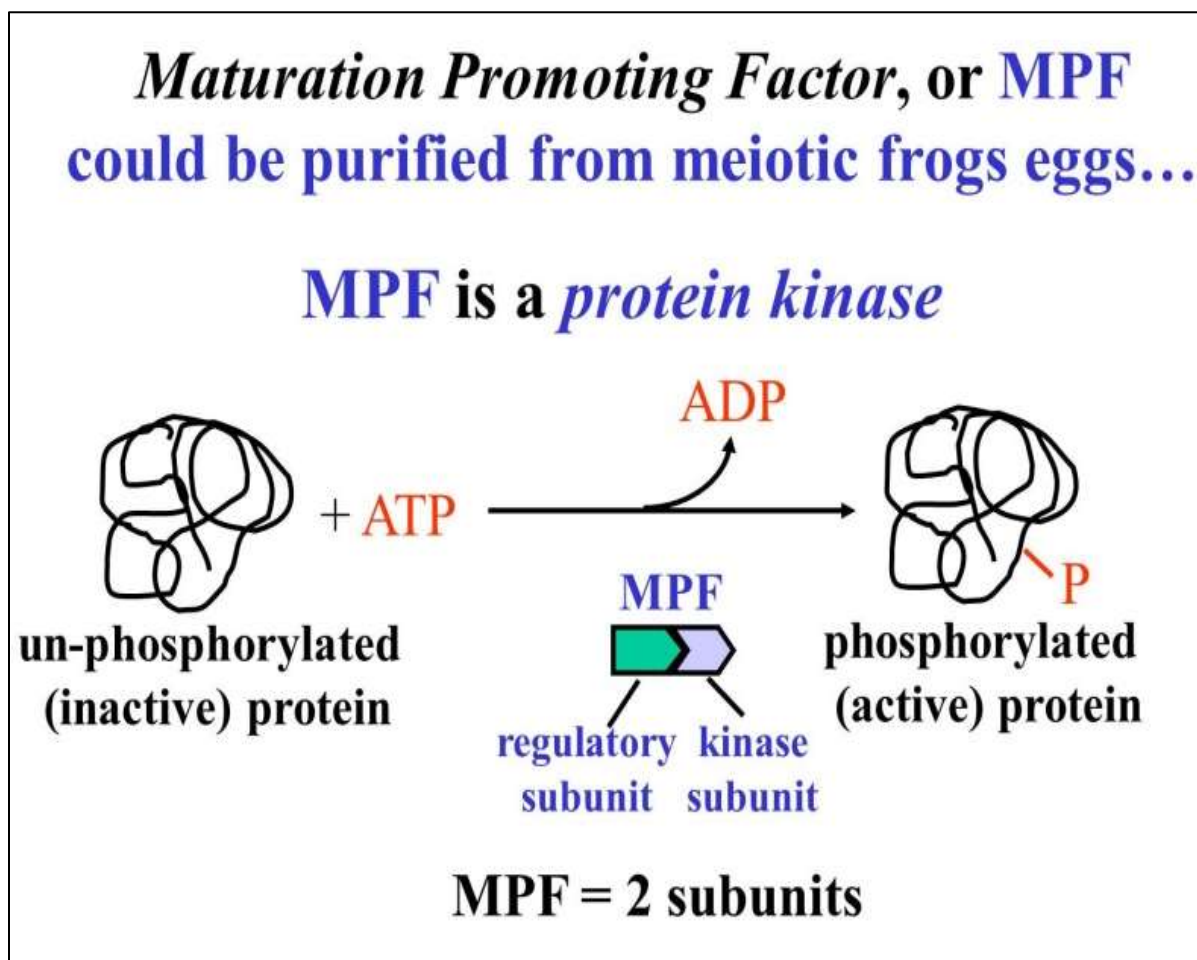

MPF was subsequently shown to stimulate somatic cells in G2 to enter premature mitosis; so conveniently, *MPF* can also be **Mitosis Promoting Factor**! Purified *MPF* from meiotic or mitotic cells turns out to be a protein kinase made up of two polypeptide subunits. When active, the kinase activity targets many cellular proteins.

One subunit (***cyclin***) is a regulatory polypeptide. The other contains the kinase enzyme *active site*. To be an active kinase, both subunits must be bound. Assays of *MPF* activity as well as the actual levels of the two subunits over time during the cell cycle are shown below.

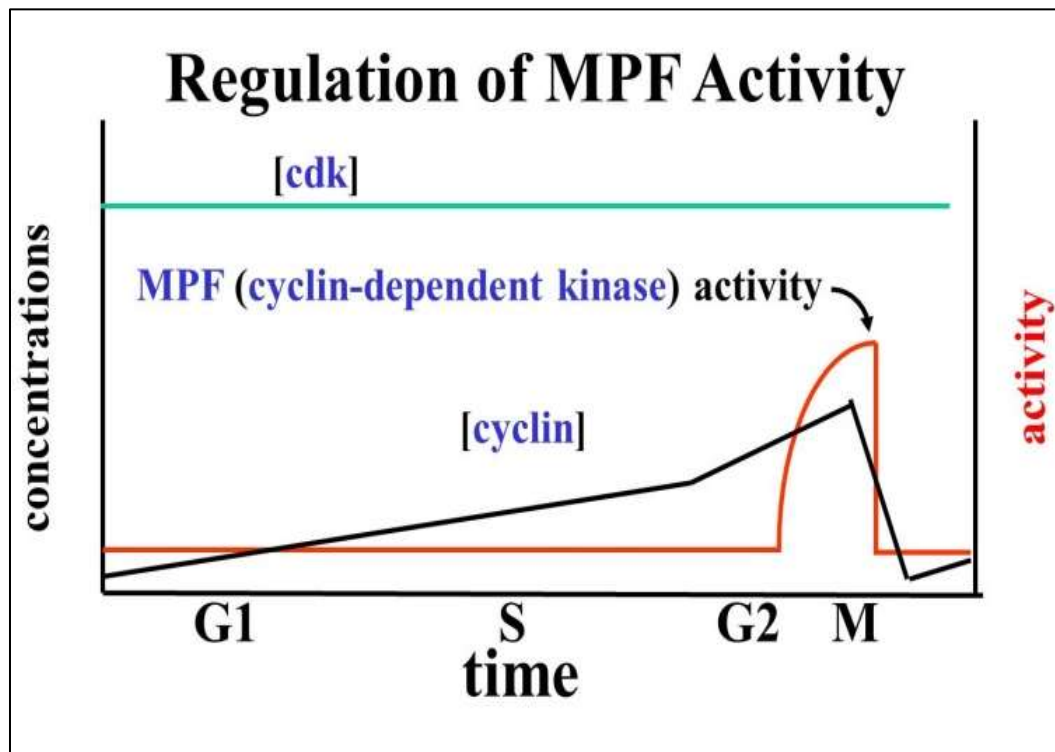

Based on this data, the regulatory subunit was called ***cyclin*** because its levels rise gradually after cytokinesis, peaking at the next mitosis/meiosis. Levels of the kinase subunit do not change during the life of the cell. Because its kinase activity required *cyclin*, the subunit was called ***cyclin-dependent kinase (cdk)***. Note how *MPF* enzyme activity and *cyclin* rise near the end of G2, peak in mitosis/meiosis and drop precipitously thereafter. We now know as a cell approaches mitosis/meiosis, *cyclin* binds to more and more *cdk* subunits, eventually reaching the threshold needed to trigger entry into meiosis or mitosis. For their discovery of these central molecules Leland H. Hartwell, R. Timothy Hunt, and Paul M. Nurse won the 2001 Nobel Prize in Physiology or Medicine.

B. Other Cyclins, CDKs and Cell Cycle Checkpoints

Other chemical signals accumulate at different points in the cell cycle. For example, cells in S were fused with cells in G1, causing the G1 cells to begin synthesizing DNA (visualized as ^3H -thymine incorporation), as shown below.

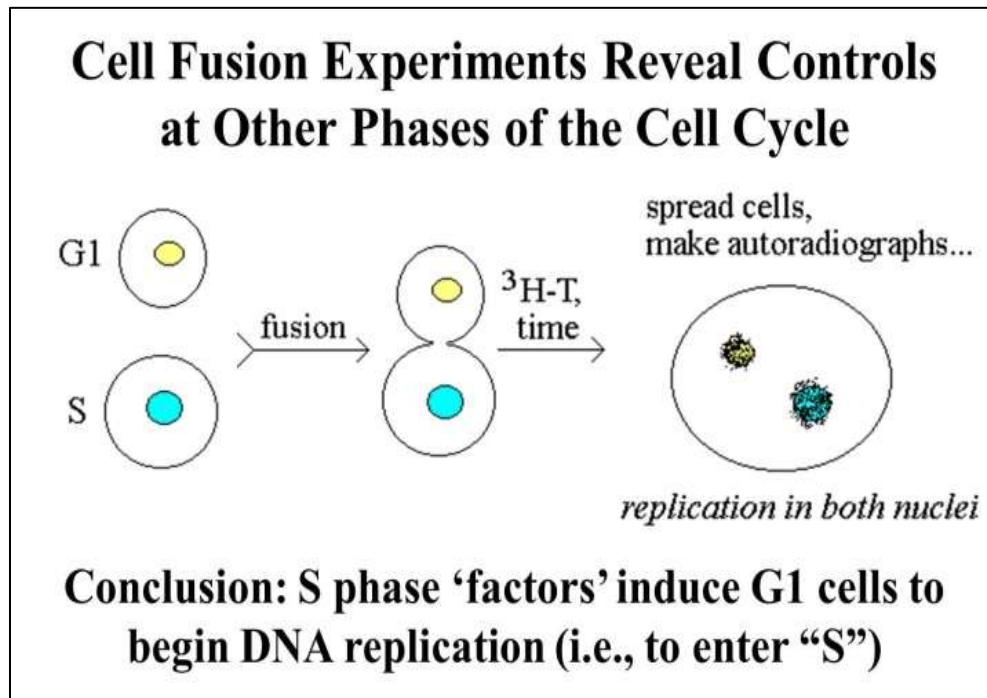

In this case, an S-phase factor was isolated. This factor also turns out to be a two-subunit protein kinase, albeit a different one from *MPF*. If the *S-phase* factor is not produced during replication, the cell does not progress to G2. Unless these and other regulatory cell cycle kinases are produced in cells at the right time, the cycle would stall and the cells would not progress to the next phase. Together, these kinases are part of a molecular sensing mechanism that act as **checkpoints** by phosphorylating cytoplasmic and/or nuclear proteins involved in upcoming phases of the cycle. Each of the factors will not be produced if the cells have not properly completed the prior phase. And if any factor is not produced, the cells will be arrested at one or another phase of the cell cycle.

CHALLENGE: What proteins (or kinds of proteins) might cdk-catalyzed phosphorylations activate that would promote progress through the cell cycle?

The sequence of signals that control progress through the cell cycle is probably more intricate and extensive than we currently know, but the three best described checkpoints are in G_1 , G_2 and M (below).

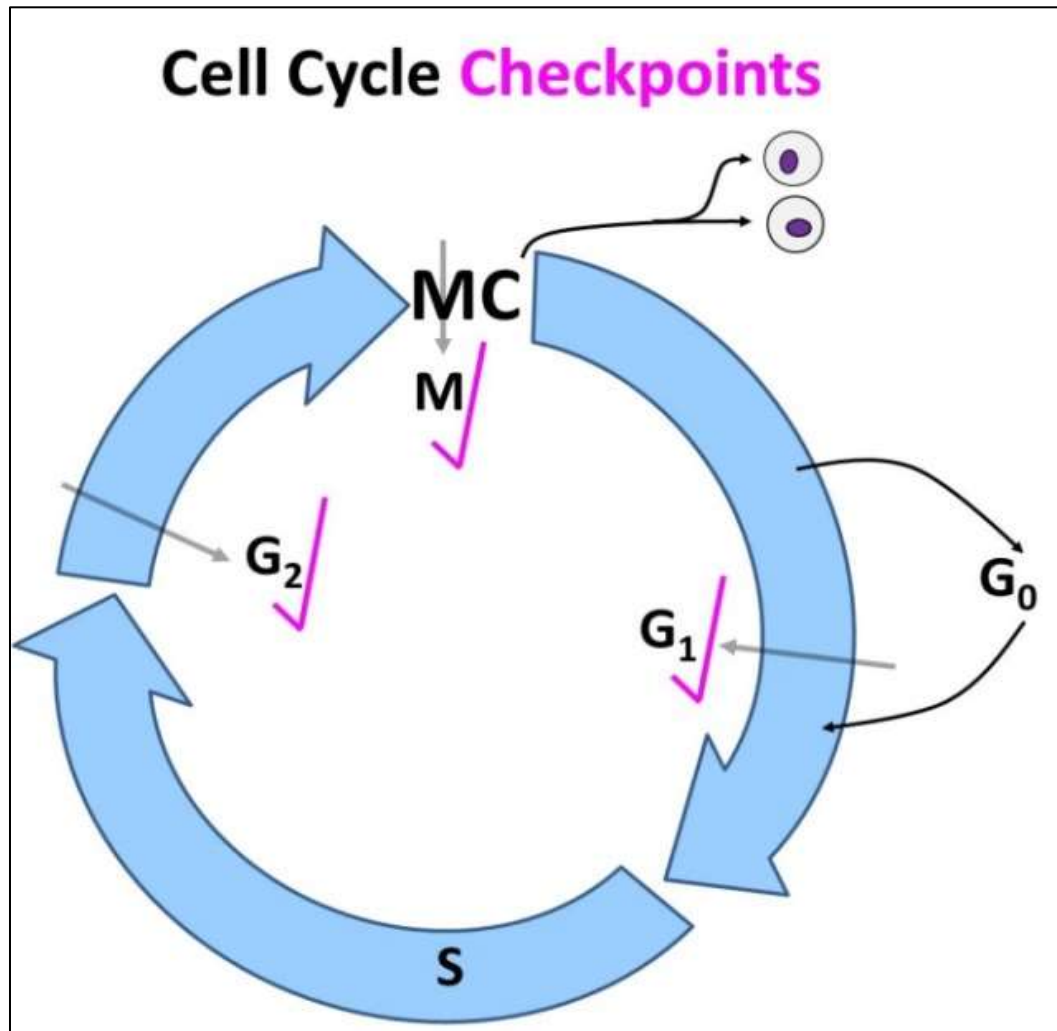

The ***G1 checkpoint*** is an interesting exception to the operation of “checkpoints” that govern the forward progress of cycling cells. When cells in a tissue are fully differentiated they are signaled to stop producing the active *G1 checkpoint* kinase. These *terminally differentiated* cells do not progress beyond G_1 into S. As we have seen, these cells are instead arrested in G_0 . Recall that somatic cells are ***diploid*** and germ cells (sperm, egg) are ***haploid***. Then are cells in G_2 that have already doubled their DNA ‘tetraploid’, at least briefly? Whether or not we can call G_2 cells tetraploid (officially, probably not), it is clear that terminally differentiated G_0 cells are diploid!

Let's take a closer look at some events that are being monitored at these *checkpoints*.

1. **The G1 Checkpoint**

We have already encountered the G1 (or '*restriction*') checkpoint, which determines whether cells will continue to the S phase. Cells will only progress to the S phase if chemicals (mostly proteins) necessary for the replication process are being made. These include enzymes of replication (DNA polymerases, helicases, primases...) and others. Only when these molecules have accumulated or become active at appropriate levels is it appropriate (and "safe"!) to enter S.

CHALLENGE: What are some other molecules that might be monitored at the G1 checkpoint.

2. **The G2 Checkpoint**

Passage through the G2 checkpoint is only possible if DNA made in the prior S phase is not damaged, or if it was, that the damage has been or can be repaired (e.g., by proofreading functions of replication or following correction of DNA damage by one of several DNA repair pathways). Cells that pass the G2 checkpoint have active genes allowing accumulation of proteins that will be needed for mitosis, such as nuclear proteins necessary to condense chromatin into chromosomes, tubulins for making microtubules, etc. Only when levels of these and other required proteins reach a threshold can the cell begin mitosis.

3. **M Checkpoint**

This is the checkpoint governed by the original *MPF*. It functions at metaphase, phosphorylating proteins that bind to chromatin causing it to condense and form chromatids. MPF-catalyzed phosphorylation also enables spindle fiber formation and the breakdown of the nuclear envelope. At metaphase, tension developed in the spindle apparatus tugs at the kinetochores holding the duplicated chromatids together. When this tension reaches a threshold level, MPF peaks and an active **separase** is produced causing the chromatids to separate. The tension in the spindle apparatus becomes the force that separates the new chromosomes in anaphase. At this time, proteins phosphorylated by MPF even initiate the breakdown of cyclin in the cell. Passing the M checkpoint means that the cell will complete mitosis (anaphase and telophase) and cytokinesis, and that each daughter cell will enter a new G1 phase.

4. *The G₀ State*

This is not really a phase of the cell cycle, since cells in G₀ have reached a terminally differentiated state and stopped dividing. In development this means that the formation of a tissue or an organ is complete. Some cells live short lives in G₀ (e.g., some embryonic cells), and others live so long in G₀ that they are seldom if ever replaced (muscle cells, neurons). An example of a differentiated cell type that can be normally reactivated from G₀ is the **lymphocyte**, an *immune system* white blood cell. Exposure to foreign chemicals or pathogens activates lymphocytes to re-enter the cell cycle where the newly divided cells make the antibodies that neutralize the chemicals and fight off the pathogens. On the other hand, if cells are unable to enter G₀ when they are supposed to, or if they are inappropriately signaled to exit G₀, they will re-enter the cell cycle. Such cells have escaped the checkpoints and controls on cell division, and may become the focal point of tumor and other cancer cell growth. To learn more, see Elledge SJ (1996) *Cell Cycle Checkpoints: Preventing an Identity Crisis*. Science 274:1664-1672.

Dividing yeast cells seem to have only the three checkpoints discussed here. More complex eukaryotes have more cell cycle controls, including more *cyclins*, more *cdks* and consequently, more *checkpoints*. Cyclins are conserved proteins encoded by related genes. Like the one in MPF, these cyclins are characterized by cyclic patterns of synthesis. Likewise, *cdks* are also encoded by evolutionarily conserved genes, and are maintained at constant levels throughout the cell cycle. Each kinase holoprotein (cyclin-bound cdk) is different, catalyzing the phosphorylation of sets of cellular proteins specific to each phase of the cell cycle.

Until recently, the effects of checkpoint action was thought to stall progress to the next phase of the cell cycle. A recent study suggests that problems in the S phase requiring DNA repair before the cell can complete G₂ and proceed to mitosis may not be resolved until mitosis is underway! Check this out at [DNA repair/replication during mitosis](#).

C. When Cells Die

As noted, few cell types live forever, and most live for a finite time. Most cells are destined to turn over (another euphemism for dying), mediated by *programmed cell death*, or **Apoptosis**. This occurs during normal development when cells are temporarily required for a maturation process (e.g., embryo formation, metamorphosis). When these cells are no longer necessary, or when a genetically or otherwise damaged cell is detected in a population of dividing cells, they undergo *apoptosis*.

Programmed cell death often starts with an external signal programmed to appear at a specific time in development. The signal molecule acts on target cells to induce transcription of the **Bcl2** gene. The *Bcl2* proteins **Bak** and **Bax** are outer mitochondrial membrane channel components that will allow the organelles to release *cytochrome C*, setting off the sequence of molecular events leading to *apoptosis*. This is animated at http://youtu.be/QL7M_j4LjVc. The effects of *cytochrome C* in the cytoplasm are illustrated below and animated at http://youtu.be/x3-ZKUbY_SY.

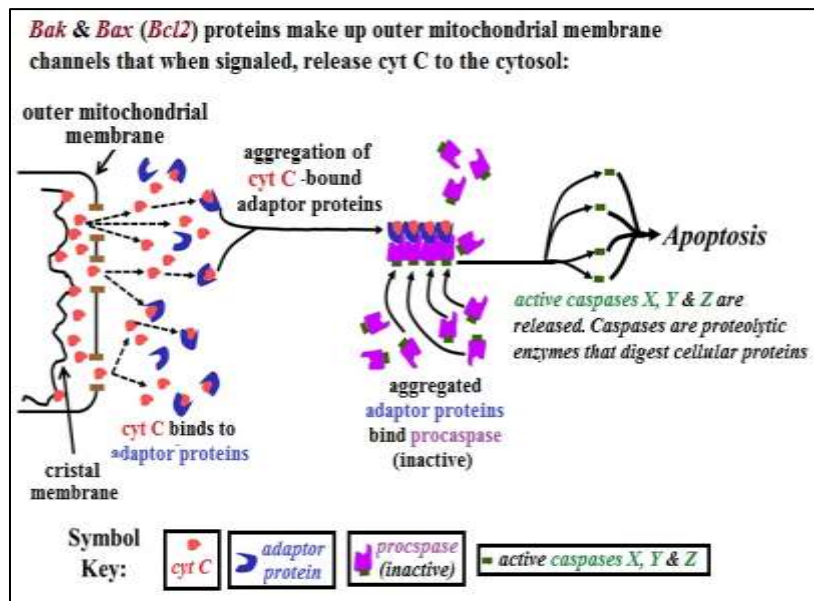

The exit of cytochrome C from mitochondria is possible because this electron acceptor is a peripheral membrane protein. It is only loosely bound to the cristal membrane, existing in equilibrium between membrane-bound and unbound states. As some cytochrome C molecules exit the intermembrane space, others detach from the cristal membrane and follow. In the cytosol, cytochrome C binds to **adaptor** proteins that then aggregate. Once aggregated the cytochrome c-adaptor complex has a high affinity for a biologically **inactive procaspase**. Binding of *procaspase* to the *cytochrome C*-*adaptor complex* causes an allosteric change in the *procaspase* which releases an active **caspase**. Active *caspases* are *proteolytic enzymes* that begin the auto-digestion of the cell. One example of apoptosis is amphibian metamorphosis. In tadpoles, the signal is *thyroid hormone*, which causes tadpole tail cells to be digested and reabsorbed. The reabsorbed molecules serve as nutrients that are used to grow adult frog structures.

For their work in identifying apoptosis genes, Sydney Brenner, H. Robert Horvitz and John E. Sulston shared the 2002 Nobel Prize in Medicine.

IV. Disruption of the Cell Cycle Checkpoints can Cause Cancer

If a checkpoint fails or if a cell suffers physical damage to chromosomes during cell division, or if it suffers a debilitating somatic mutation in a prior S phase, they may self-destruct in response to a resulting inappropriate biosynthesis or other biochemical imbalance. This is another example of *apoptosis*. But when cells die from external injury, they exhibit necrosis, an accidental rather than a programmed death. The difference between necrosis and apoptosis can be seen in electron micrographs of cells, below.

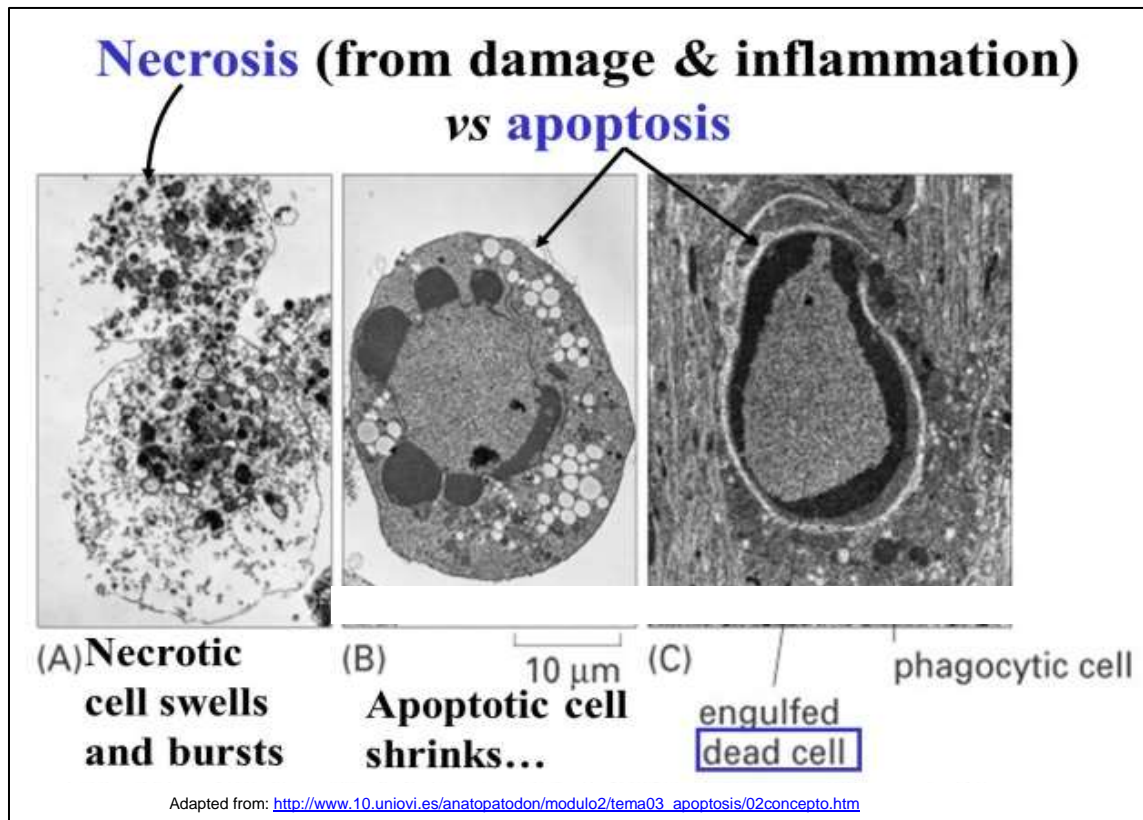

In the normal course of events, cycling cells continue to divide until they attain G_0 in the terminally differentiated state. We noted that most terminally differentiated cells have a finite lifespan in an organism, to be cleared by *apoptosis* and replaced by stem cells. We also noted that accidental signaling can bring cells out of G_0 , leading to renewed cell proliferation. While these cells are obviously abnormal, they are not detected by apoptotic defense mechanisms, so that they undergo uncontrolled cell divisions to become cancer cells. Likewise, physically damaged cells or cells with certain kinds of mutations may sometimes escape clearance by apoptosis. When they do, they may also become cancer cells.

Apoptotic clearance and the uncontrolled proliferation of cancer cells are shown below.

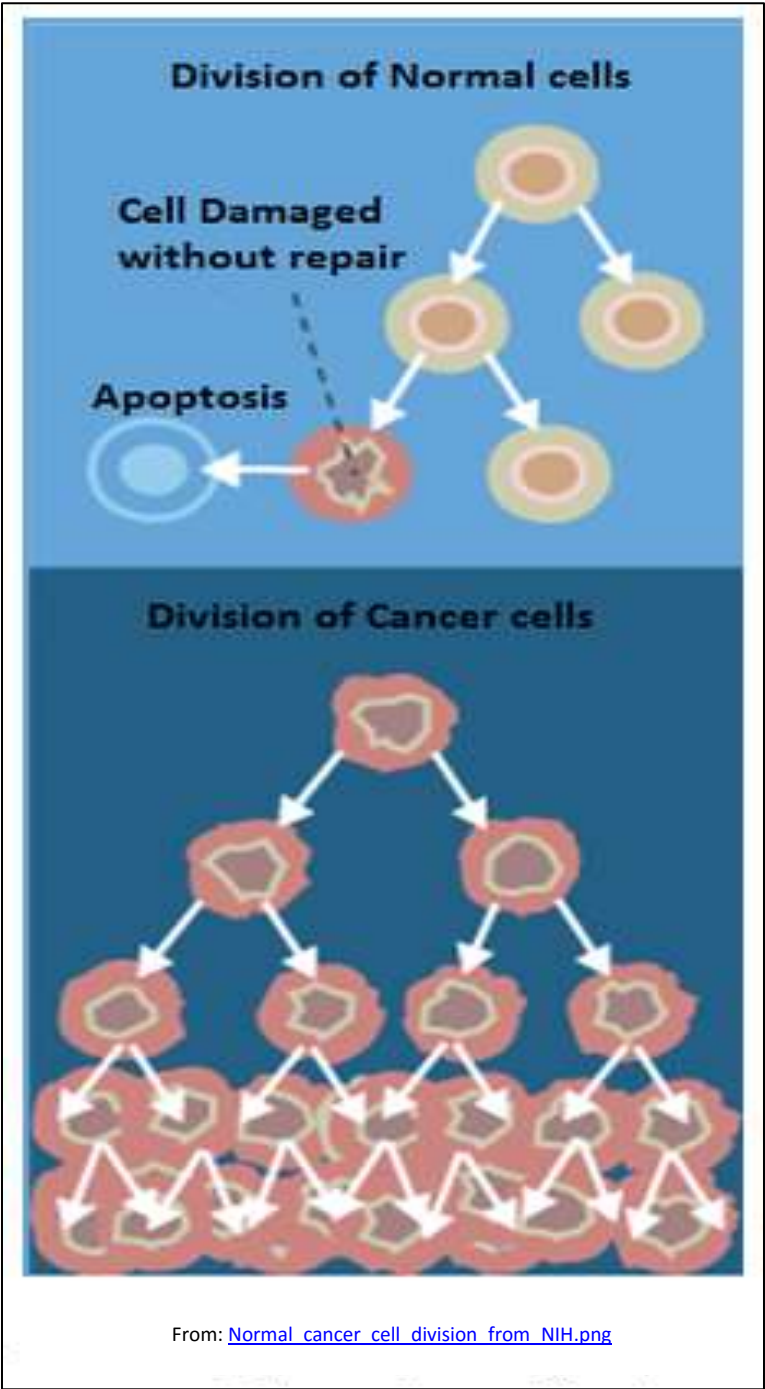

A. P53 Protein Mediates Normal Cell Cycle Control

Cancerous growth could result if a normal dividing cell should suffer a somatic mutation that disrupts normal cell cycle control. Think an over-expression of *cdk* for example. Or *cyclin* levels in daughter cells that never drop; such cells would never stop cycling.

CHALLENGE: Why a somatic mutation? What does it mean to say that certain cancers run in families, or that specific genes are associated with a particular cancer?

Other possibilities include a cell in G_0 stimulated to begin cycling again by an inappropriate encounter with a hormone or other signal. If undetected, these anomalies can transform cells to cancer cells. The **p53** protein (illustrated below) is a DNA-binding gene-regulatory protein that detects some of these anomalies and enables dividing cells to repair the damage before proceeding through cycle check points, or failing that will lead to apoptosis of the cell.

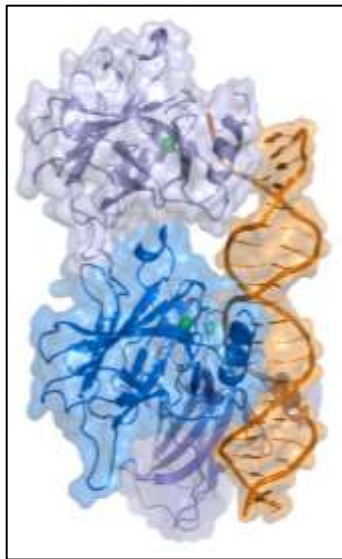

From:
<https://upload.wikimedia.org/wikipedia/commons/b/bb/P53.png>

Not surprisingly, mutations in the gene for the **P53 protein** (called TP53 in humans) are associated with many human cancers (pancreatic, lung, renal cell, breast, etc.). As many as half of human cancers are associated with mutated p53 genes. Thus, p53 is one of a class of **tumor suppressor proteins**. Studies of humans with a condition

known as **LFS** (*Li-Fraumeni syndrome*) have at least one mutated p53 allele. The mutation leads to a high lifetime risk (~100%) of cancer, beginning in childhood. In cultured cells in which the p53 gene is mutagenized, the cells exhibit key characteristics of cancer cells, including unregulated cell proliferation and suppression of apoptosis.

1. How p53 works

Normally, the p53 protein has a short half-life, in part because it is bound to an active **Mdm2** protein. To function in enabling cell cycle checkpoints, p53-Mdm2 must separate and be kept separate to allow p53 time to act. So, in response to stress (physical or chemical, such as DNA damage) an ATM *kinase* is activated and then phosphorylates **Mdm2**, causing it to dissociate from p53. The same kinase also phosphorylates another protein, **Chk2**, as well as the now 'free' **p53**. Phospho-p53 (active p53) up-regulates the **p21** gene, resulting in **p21 protein** synthesis. **P21** protein binds to CDKs responsible for the G1-to-S phase transition, forcing the arrest of the cell cycle while the cell attempts to repair DNA or other cell-division damage. If repair is successful the cell can progress from G1 to the S phase. If not, phosphorylated (active) Chk2 protein will initiate apoptosis. While active Chk2 has already bound and inactivated cyclin to slow/stop the cycle and allow DNA repair, if repair is not possible the Chk2-cyclin is targeted for degradation by proteasomes. Likewise, active (dephospho-) Mdm2 bound to remaining p53 is also targeted for proteasome destruction. The result is that the cell unable to repair DNA damage and progress through the cell cycle is diverted to an apoptotic fate. The actions of the ATM kinase are illustrated below.

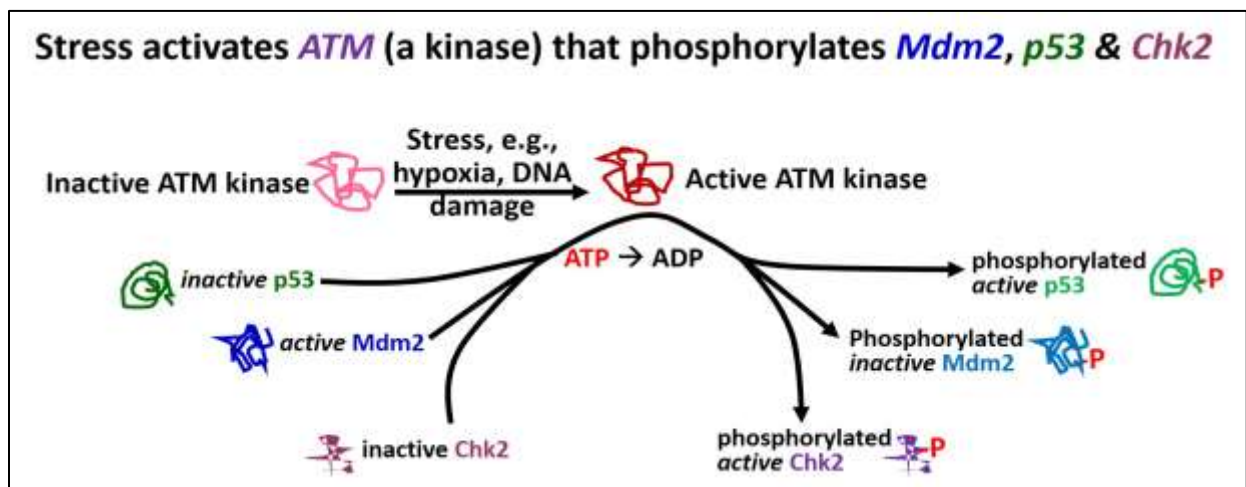

The levels and activity of p53 and the other proteins shown above control both the amount of p53 protein available to respond to cell cycling anomalies, and the responses themselves. The responses to activated (phosphorylated) p53 include

a rapid arrest of the cell cycle and activation of genes for DNA repair proteins and enzymes as well as of proteins required for apoptosis (in the event that repair efforts fail). The interactions of p53 with some of these proteins are summarized below.

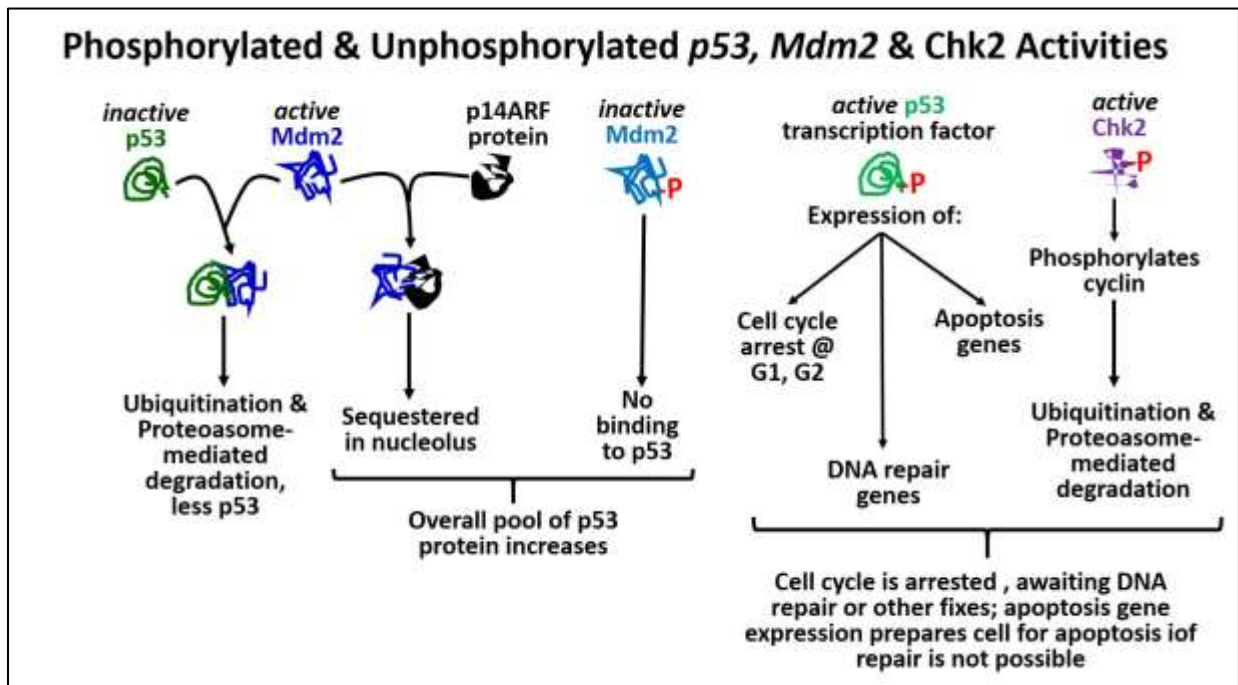

To sum up, the p53 protein suppresses malignant tumor growth by either allowing DNA or cellular repair before resumption of normal cell cycling, preventing unregulated cell divisions... or it sets off events leading to apoptosis, thereby also blocking tumorigenesis. If repair was possible, the p53 and other proteins are inactivated and/or destroyed and the cell cycle can resume. A mutant p53 that reduces or eliminates p21 or other essential DNA repair protein production will allow damaged cells to enter S and keep replicating and dividing.

In an interesting twist, it turns out that compared to humans, very few whales and elephants die from cancer, despite having thousands of times more cells than humans. The reason seems to be that, at least for elephants, they have as many as 20 copies (40 alleles) of their p53 genes... thus a mutation in one allele of one of them may have little effect; the tumor-repressing effects of the remaining p53 genes prevails. Read about this recent research at [Whales and Elephants Don't Get Cancer!](#)

2. The Centrality of p53 Action in Cell Cycle Regulation

Because of its multiple roles in regulating promoting DNA repair and controlling cell cycle checkpoints, p53 has been called “the Guardian of the Genome”! Here is some further evidence of this central role.

a) ‘Oncogenic Viruses’

Cancer causing viruses include Human Papilloma Virus (**HPV**), Epstein Barr Virus (**EBV**), Hepatitis B and C viruses (**HBV**, **HCV**), human immunodeficiency virus (**HIV**), Human herpes virus 8 (**HHV-8**) and simian virus 40 (**SV40**), among others.

CHALLENGE: If you don’t already know the cancers linked to these viruses, try a few searches to find out!

A link between SV40, p53 and cancer has been shown. SV40 was identified as a viral contaminant of polio vaccines in the 1960s. SV40 is tumorigenic in mammals, though an association of SV40 and cancer in humans is ambiguous. In infected cells, SV40 DNA enters the nucleus where it can be integrated into the host cell genome. SV40 infections are usually latent, (i.e., they cause no harm). But activation can lead to cellular transformation and the formation malignant sarcomas in muscles as well as tumors in other organs. When activated, SV40 genes are transcribed by cellular RNA polymerase II into mRNAs that encode proteins needed to replicate viral DNA and encapsulate the DNA in a membrane to create new viral particles. However, the relatively small SV40 genome does not encode all of the enzymes and factors need for viral DNA replication. So SV40 relies on host (infected) cells to provide these factors, which of course can only be made by the cell in the S phase. At that time, the SV40 **large T antigen** made early after infection, enters the host cell nucleus where it regulates transcription of genes essential to replication and viral particle formation. While in the nucleus, the *large T antigen* also binds to p53, interfering with transcription of p53 regulated proteins. Unable to exercise checkpoint functions, the host cell divides uncontrollably, forming cancerous tumors. SV40 large T antigen deregulation of the cell cycle ensures progression to the S phase and the unregulated co-replication of viral and host DNA.

b) *p53 and Signal transduction*

Stress can activate signal transduction pathways. For example, mutations affecting **MAPK** (MAP kinase) signaling pathway can lead to tumorigenesis. This can be explained by the observation that when activated, the MAPK pathway leads to amplified production of a kinase that phosphorylates p53. The active (phosphorylated) p53 can in turn augment activation of the MAPK signal transduction pathway. You may recall that MAPK signal transduction typically ends with a mitogenic response.

Another example of p53 interaction is with the **FAK** (*focal adhesion kinase*) protein. FAK activity is increased via the *integrin*-mediated signal transduction (recall that integrin in membranes binds fibronectin, contributing to formation of the extracellular matrix, or *ECM*). Elevated FAK activity participates in the regulation of cell-cell and cell-ECM adhesion at *focal adhesion points*. But in addition to its enzymatic role as a kinase, FAK also binds directly to inactive p53, enhancing p53-Mdm2 binding and therefore p53 ubiquitination... and destruction. In fact, higher-than-normal levels of FAK are associated with many different cancer tumor cell lines (colon, breast, thyroid, ovarian, melanoma, sarcoma...) that result when p53 is unable to properly activate cell cycle checkpoints.

While the interactions implied here are complex and under active study, these p53 activities certainly confirm its central role as both “guardian of the genome” and as “guardian of cell division”.

B. Growth and Behavior of Cancer Cells

Different cancer cell types have different growth and other behavioral properties. You may have heard of **slow growing** and **fast growing** cancers. *Colon* cancers are typically slow growing. In middle-age or older people, periodic colonoscopies can detect and remove colorectal tumors. *Pancreatic* cancers are fast growing and often go undetected until they reach an advanced stage. The twin goals of medical research are to detect the different cancers early enough for successful intervention, and of course to find effective treatments.

A single mutated cell in a tissue can become the growth point of a **tumor**, essentially a mass of cells cloned from the original mutated one. **Benign tumors** or growths (for example breast and uterine *fibroids* in women, or common moles) stop growing and are not life threatening. They are often surgically removed for the comfort of the patient (or because cells in some otherwise benign tumors have a potential to become cancerous).

Malignant tumors (also called *malignant neoplasms*) are cancerous and can grow beyond the boundaries of the tumor itself. When tumor cells are shed they may enter the bloodstream and travel to other parts of the body (the phenomenon called **metastasis**), where they can initiate the growth of more tumors. Because cancer cells continue to cycle and replicate their DNA, they can undergo additional somatic mutations. These further changes can facilitate metastasis and cancer cell growth in different locations in the body.

CHALLENGE: Where might you look for mutations that could be most directly involved in metastasis?

C. Cancer Treatment Strategies

There are many different kinds of cancers originating in different tissues of the body. They all share the property of uncontrolled cell division, albeit for different molecular and not well known reasons. The two major treatment strategies for cancers all aim at disrupting replication in some way. For example, **radiation therapy** aims mutagenic radiation at tumors in the hope that replicating DNA will be mutated at so many sites (i.e., genes) that they can no longer survive. Some tumors do not respond well to radiation (or can't easily be reached by radiation technologies), and some cancers do not even form focused tumors (for example lymphomas and leukemias involving lymph and blood cells). These are treated by **chemotherapy**, which also aims to derange replication or mitotic activities. One of the dideoxynucleotides we saw used in the Sanger method of DNA sequencing, ddCTP is in fact a chemotherapeutic agent (called **cordycepin**) because once it is incorporated into a growing DNA chain during replication, no additional nucleotides can be added to the DNA strand. **Taxol** is another chemo drug that acts by blocking spindle fiber microtubules from depolymerizing, thus blocking mitosis. These therapies are not necessarily specific for cancer cell types. When they are successful it is because cancer cells proliferate rapidly and constantly while other cell types do not.

The message you should be getting is that we have a long way to go before we develop cancer therapies that target specific cancers rather than spraying shotgun pellets at the DNA of all dividing cells. Many if not all of the side effects of radiation and chemical therapies result from the damage these treatments do to normal dividing cells (e.g., hair follicle cells accounting for hair loss among many cancer patients, depletion of blood cells that fail to be replaced by stem cells in bone marrow). So, we must wait for more specific cancer treatments, perhaps immunotherapies that will recognize only cancer and not normal cells.

Some iText & VOP Key Words and Terms

anaphase	G2 checkpoint	mTOR signaling
apoptosis	G2 phase	necrosis
ATM kinase	<i>Guardian of the Genome</i>	oncogenic viruses
benign tumors	integrin	p14ARF
cancer cells	interphase	p21
CDKs	invasive tumors	P53
cell cycle	LFS	programmed cell death
cell cycle checkpoints	Li-Fraumeni Syndrome	prophase
chemotherapy	M checkpoint	protein phosphorylation
Chk2	M phase of the cell cycle	proteasome
colchicine	malignant tumors	radiation therapy
cyclin	MAPK	S phase
cyclin level in cell cycle	maturation	signal transduction
cyclin-dependent kinases	maturation promoting factor	SV40
cytokinesis	Mdm2	T antigens
dideoxyNTP chemotherapy	metaphase	taxol
elephant p53 genes	metastasis	telophase
FAK	mitosis	tumor suppressor protein
G ₀ of the cell cycle	mitosis promoting factor	ubiquitination
G1 checkpoint	mitotic phases	
G1 phase	MPF	

Chapter 18: The Origins of Life

A short history; Origins under reductive vs. non-reductive conditions; Prebiotic chemical and metabolic evolution; Origins of communication (catalysis, autocatalysis, co-catalysis, biochemical pathways; Transition from the RNA World

From: <http://pandasthumb.org/archives/2010/02/03/PrimordialSoupPPR.jpg>



I. Introduction

It is nearly universally accepted that there was a time, however brief or long, when the earth was a lifeless planet. Given that the cell is the basic unit of life, and that to be alive is to possess all of the properties of life, this and any cell biology textbook would be remiss without addressing the questions of **when** and **how** the first cells appeared on our planet. Here is a reminder of those properties.

The Properties of Life	
Evolution:	long-term adaptation/speciation
Cell-based:	Cell=fundamental <i>unit of life</i>
Complexity:	<i>dynamic order</i> ; allows physical/biochemical change
Homeostasis:	maintains <i>balance</i> between <i>change</i> and <i>order</i>
Requires Energy:	needed to do <i>work</i> , i.e., all cellular functions
Irritability:	immediate sensitivity and response to stimuli
Reproduction:	sort of self-explanatory, yes?!
Development:	<i>programmed change</i> ; most obvious in multicellular organisms, but also found in prokaryotes

Remember, to be alive is to possess not just some, but all of these properties!

Abiogenesis is the origin of life from “non-living matter”. Of course describing abiogenesis is no longer possible by observation! But through experiment and educated guesswork, it has been possible to construct reasonable (if sometimes conflicting) scenarios to explain the *origins* of life, and hence our very existence. Note the italicized plural “origins”! In this chapter we will see that different scenarios share at least one feature, namely a set of geologic, thermodynamic and chemical conditions that favored an accumulation of organic molecules and proto-structures that would eventually become a cell. Those permissive conditions would have been an ecological, climatological, and environmental *prebiotic* laboratory in which but many experimental cells could have formed and competed. Origins of life were not only possible under these conditions, but probable! According to Jeremy England, of MIT, “... when a group of atoms is driven by an external source of energy (like the sun or chemical fuel) and surrounded by a heat bath (like the ocean or atmosphere), matter inexorably acquires the key physical attribute associated with life”. (<http://www.englandlab.com/uploads/7/8/0/3/7803054/2013jcpsrep.pdf>).

Cells of independent origins with all of the properties of life would have reproduced to form separate populations of cells. In this scenario, less successful populations go extinct and successful ones become dominant. Successful organisms spread spawning populations and generating new species. The **take-home message** is that if conditions on a prebiotic earth favored the formation of the ‘first cell’, then why not the formation of two, or dozens or even hundreds of ‘first cells’? One successful population of cells would be the source of the common ancestor of all life on earth..., the **Last Universal Common Ancestor**, or **LUCA**.

As to the question of **when** life began, geological and geochemical evidence suggests the presence of life on earth as early as 4.1 billion years ago. As to **how** life began, this remains the subject of ongoing speculation. *All* of the scenarios described below attempt to understand the physical, chemical and energetic conditions that might have been the ideal laboratory for prebiotic “*chemistry experiments*”. What all the scenarios share are the following requirements.

All Origins of Life Scenarios Must Explain:

- Prebiotic synthesis of organic molecules and polymers
- the origins of catalysis & replicative biochemistry
- the sources of free energy to sustain prebiotic biochemistry
- The beginnings of metabolism sufficient for life
- The origins molecular information storage and retrieval
- Enclosure of life’s chemistry by a semipermeable membrane

Whatever the pathway to the first living cells on earth, molecular studies over the last several decades support the common ancestry of all life on earth. The **progenote**, or **LUCA** was a cell that accomplished all of the prerequisite functions of life with a biochemistry now shared among all things alive today. Below is a phylogenetic tree of life domains that we have seen before, with the *LUCA* at its root.

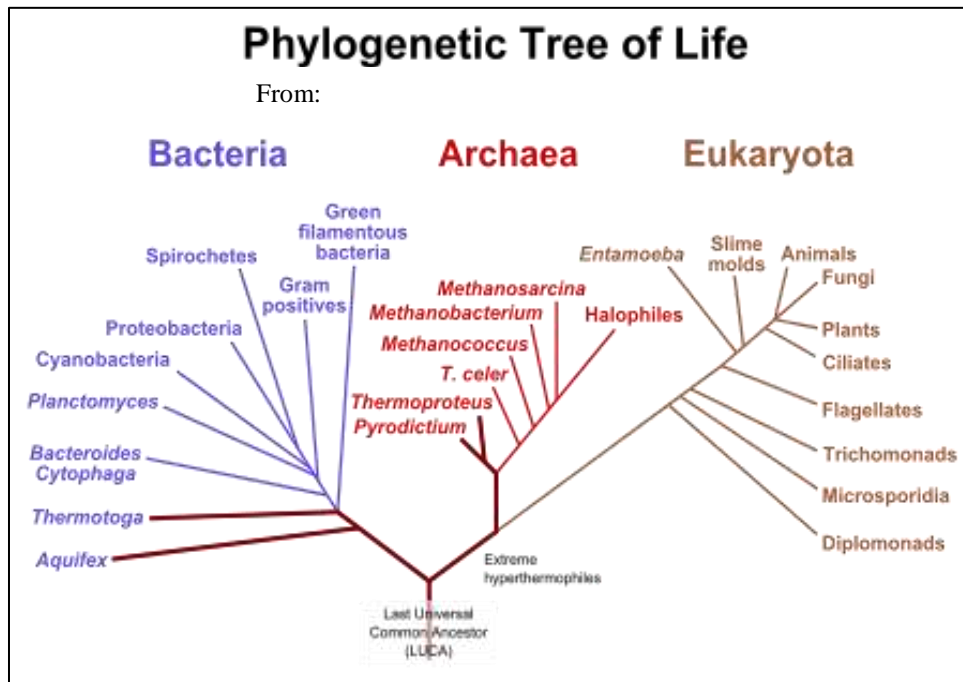

So, how did we get to the progenote, or the LUCA? Common features of life-origins hypotheses are:

- Reduction of inorganic molecules to form organic molecules
- a source of free energy to fuel the formation of organic molecules
- a scheme for catalytic acceleration of biochemical reactions
- separation of early biochemical 'experiments' by a semipermeable boundary.

Proposed scenarios for the creation of organic molecules include:

- import of organic molecules (or even life itself) from **extraterrestrial** sources.
- organic molecule synthesis on an earth with a **reducing atmosphere**.
- organic molecule synthesis on an earth with a **non-reducing atmosphere**.

Here we'll explore a few alternate free-energy sources and pathways to the essential chemistry of life dictated by these different beginnings. Then we look at possible

scenarios of chemical evolution that must have occurred before life itself. Finally, we'll consider how primitive (read "simpler") biochemistries could have evolved into the present-day metabolisms shared by all existing life forms.

Challenge Question: The terms *progenote* and *LUCA* are sometimes used to mean the same thing. Write definitions that would distinguish the progenote from the LUCA.

Voice-Over PowerPoint Presentations

Life Origins Part 1 [need link](#)

Life Origins Part 2 [need link](#)

Learning Objectives

When you have mastered the information in this chapter and the associated VOPs, you should be able to:

1. explain how organic molecules would capture chemical energy on a prebiotic earth.
2. list the essential chemistries required for life and why they might have been "selected" during chemical evolution.
3. discuss the different fates of prebiotically synthesized organic monomers and polymers and how these fates would influence the appearance of the first cells on earth.
4. compare and contrast two scenarios for an extraterrestrial origin of organic molecules.
5. summarize the arguments against Oparin's primordial soup hypothesis.
6. summarize the evidence supporting origins of life in a non-reducing atmosphere on earth.
7. compare the progenote and the LUCA.
8. discuss the evidence suggesting an origin of cellular life in the late Hadean eon.
9. describe how life might have begun in deep ocean vents – compare the possibilities of life beginning in *black smokers* vs. *white smokers*.
10. argue for and against an '*autotroph-first*' scenario for cellular origins.
11. explain why some investigators place significance on the early origins of free energy storage in inorganic proton gradients.
12. define autocatalysis, co-catalysis and co-catalytic sets; provide examples.
13. define **coevolution**.
14. describe the significance and necessity of 'coevolution' before life. In what ways is coevolution a feature of living things? Explain.

II. Thinking about Life's Origins: A Short Summary of a Long History

By all accounts, the earth must have been a very unpleasant place soon after its formation! For that reason, period from 4.8 to 4.0 billion years ago is called the **Hadean Eon**, after Hades, the hell of the ancient Greeks! Geological, geochemical and fossil evidence suggests that life arose between 3.8 and 4.1 billion years ago. But questions about life's origins are probably "as old as the hills..." or at least as old as the ancient Greeks! We only have records of human notions of life's origins dating from biblical accounts and, just a bit later, from Aristotle's musings. While Aristotle did not suggest that life began in hell, he and other ancient Greeks did speculate about life's origins by *spontaneous generation*, in the sense of *life* originating from *non-life*. He further speculated that the origins of life were gradual.

Later, in the middle ages, notions of origins and evolution were muted, at least in Europe, by the dominant theological accounts of creation. A few mediaeval voices ran counter to strict biblical readings of the creation stories, but it was not until the Renaissance period (14th-17th century) that an appreciation of ancient Greek *humanism* was reawakened, and with it, scientific curiosity and the ability to engage in rational questioning and research.

Many will recall that it was Louis Pasteur in the mid-19th century who put any notions of life forming from dead (e.g., rotten, or fecal) matter by showing that life would not form in sterilized nutrient solutions unless the broth was exposed to the air. Fewer know that much earlier, Anton Van Leeuwenhoek, the 17th century microscopist who first described bacteria and *animalcules* (mostly protozoa in pond water), tested the notion of spontaneous generation. By observing open and sealed containers of meat over time, he became convinced that 'large' animals like fleas and frogs did not arise on their own from putrid meat or slime. He also declared that insects come from insects and not from the flowers they visited. No lesser light than [Charles Darwin](#) suggested in 1859 that life may have begun in a "*warm little pond, with all sorts of ammonia and phosphoric salts, light, heat, electricity, &c., present, that a proteine compound was chemically formed ready to undergo still more complex changes.*" He even realized that these chemical constituents would not have survived in the atmosphere and waters of his day, but must have done so in a prebiotic world. In *On the Origin of Species*, he referred to life having been 'created'. Darwin was not referring to a biblical basis of creation, but clearly meant that life originated "*by some wholly unknown process*" at a time before which there was no life. Finally, Pasteur's definitive 1861 contribution was that 'invisible' *microbial life* likewise did not arise by spontaneous generation. Thus for creatures already on earth, they could only arise by **biogenesis** (*life-from-life*), the opposite of **abiogenesis** which now applies to only the first origins of life!

Among Darwin's friends and contemporaries were Charles Lyell and Roderick Murchison, both geologists who understood much about the slow geological changes that shaped the earth. Darwin was therefore familiar with the concept of extended periods of geological time, time he believed was necessary for the natural selection of traits leading to species divergence.

Fast-forward to the 1920s when J.H.B.S. Haldane and Alexander Oparin venture an hypothesis about the life's origins based on notions of the chemistry and physical conditions that might have existed on a **prebiotic earth**. Their proposal was based on the assumption that the earth's atmosphere was hot, hellish and reducing (i.e., filled with inorganic molecules able to give up electrons and hydrogens). There are more than a few hypotheses for which chemicals were already present on earth, or that formed when the planet formed about 4.8 billion years ago. We'll start our exploration with Oparin and Haldane's *reducing atmosphere*. Then we'll look at possibility that life began under *non-reducing conditions* (with passing reference to a few other ideas).

III. The Formation of Organic Molecules in an Earthly Reducing Atmosphere

A prerequisite to the prebiotic chemical experimentation is a source of organic molecules. Just as life requires energy (to do anything and everything!), converting inorganic molecules into organic molecules requires an input of *free energy*. Today, most living things get free energy by oxidizing nutrients or directly from the sun by photosynthesis. Recall that in fact all the chemical energy of life ultimately comes from the sun. But before there were cells, how did organic molecules form inorganic precursors?

Oparin and Haldane hypothesized a reductive atmosphere on the prebiotic earth, rich in inorganic molecules with 'reducing power' like H_2 , NH_3 , CH_4 , and H_2S , as well as CO_2 to serve as a carbon source. The predicted physical conditions on this prebiotic earth were:

- Lots of water (oceans)
- Hot (no free O_2)
- Lots ionizing (e.g., X-, γ -) radiation from space, (no protective ozone layer)
- Frequent ionizing (electrical) storms generated in an unstable atmosphere
- Volcanic and thermal vent activity

Oparin suggested that these abundant sources of free energy fueled the reductive synthesis of the first organic molecules to create what he called a "primeval soup". No doubt he called his primeval concoction a "soup" because it would have been rich in chemical (nutrient) free energy. While there are now challenging questions about the premise of a prebiotic reducing environment, the Oparin/Haldane proposal is still the best-known explanation for organic molecule synthesis, in no small part thanks to the experiments of Stanley Miller and Harold Urey.

Miller and Urey tested the prediction that under Haldane and Oparin's pebiotic earth conditions, inorganic molecules could produce the organic molecules in what came to be called the *primordial soup*. Their famous experiment in which they provided energy to a mixture of inorganic molecules with reducing power is illustrated below.

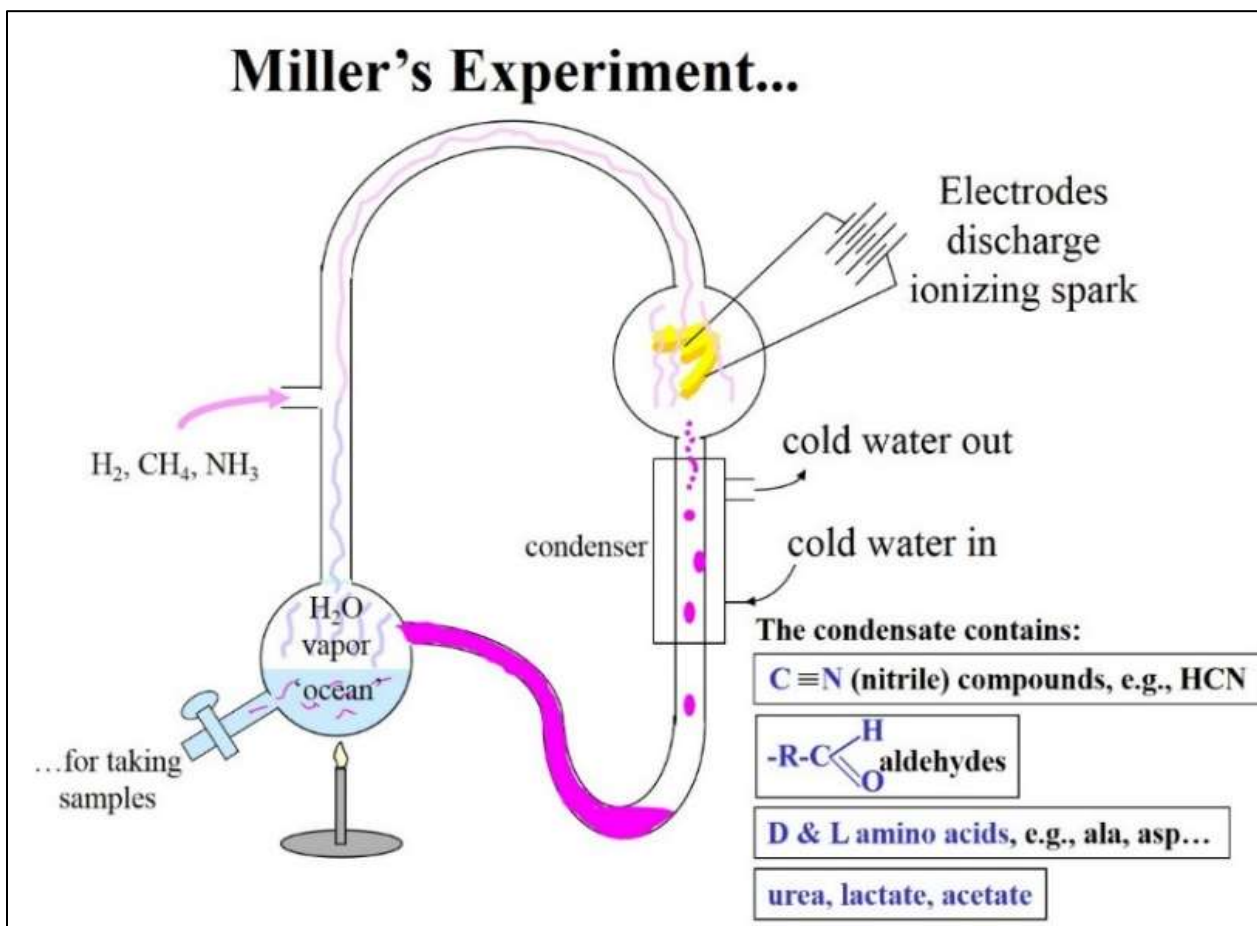

Miller's earliest published data indicated the presence of several organic molecules in their *ocean flask* including a few familiar metabolic organic acids (lactate, acetate) and amino acids... as well as several highly reactive *aldehydes* and *nitriles*. The latter can interact in spontaneous chemical reactions to form organic compounds. Later analyses further revealed purines, carbohydrates and fatty acids in the ocean flask. Later still, 50 years after Miller's experiments (and a few years after his death) some un-analyzed sample collection tubes from those early experiments were discovered. When the contents of these tubes were analyzed with newer, more sensitive detection techniques, they were shown to contain additional organic molecules not originally reported including 23 amino acids (to read more, click [Surprise Goodies in the Soup!](#)).

Clearly, the thermodynamic and chemical conditions proposed by Oparin and Haldane could support the *reductive synthesis* of organic molecules. The evolving chemistres proposed by Oparin and Haldane would likely have been internalized within semipermeable boundaries, in aggregates destined to become cells (examples of such structures are discussed below). A nutrient-rich primordial soup would likely have favored the genesis of *heterotrophic* cells that could use environmental nutrients for energy and growth, implying an early evolution of fermentative pathways similar to glycolysis.

However, these first cells would quickly consume the nutrients in the soup, bringing the earth's new vitality to a quick end! So, one must propose an early evolution of least small populations of cells that could capture free energy from inorganic molecules (chemoautotrophs) or even sunlight (photoautotrophs). As energy-rich organic nutrients in the 'soup' declined, autotrophs (notably photoautotrophs that could split water using solar energy) would be selected. Photoautotrophs would 'fix' CO₂, restoring carbohydrates and other nutrients to the oceans and adding O₂ to the atmosphere. Oxygen would have been toxic to most cells, but a few already had the ability to survive oxygen. Presumably these would have spread and evolved into cells that could *respire*, i.e., use oxygen to *burn* environmental nutrients. Respiratory metabolism must have followed hard on the heels of the spread of photosynthesis that began between 3.5 and 2.5 billion years ago (the Archaean Eon). Eventually, photosynthetic and aerobic cells and organisms achieved a natural balance to become the dominant species in our oxygen-rich world.

All in all, this scenario hangs together nicely, and has done so for many decades. But as we noted, newer evidence points to an earth atmosphere that was not reductive at all, casting doubt on the idea that the first cells on the planet were heterotrophs. More recent proposals are based on alternative sources of free energy and organic molecules that would have preceded life. These look quite different from those assumed by Oparin, Haldane and Miller.

IV. Origins of Organic Molecules in a NON-Reducing Atmosphere

Suggestions of a non-reducing earth atmosphere are based on several factors: (1) The early earth would have had insufficient gravity to hold H₂ and other light gasses; the resulting "outgassing" would have resulted in a loss of H₂ and other reducing agents from the atmosphere. (2) Geological evidence suggests that the earth's oceans and crust formed early in the Hadean Eon, just a few hundred million years after formation of the planet. (3) Studies of 4.4 billion year old (early Hadean Eon) Australian *zircon* crystals suggest that their oxidation state is the same as modern day rocks. That means that the early Hadean atmosphere was largely N₂ and CO₂, a distinctly *non-reducing* one!

A sample of this Australian zircon is shown below.



From: [Old Zircon Crystal fragment: The Oldest Known Piece of Earth](#)

How far back can we date the appearance of the first cells on earth? Solid geological evidence of life is found between 3.5 to 3.8 billion years ago (i.e., the *Archaean Eon*). Softer evidence of microbial life exists in the form of graphite and other ‘possible’ remains as old as 4.1 billion years ago, near the end of the Hadean Eon. So whether or not life began 3.5 or 4.1 billion years ago, its beginnings may have had to contend with a non-reducing environment. Assuming a non-reducing environment, some alternative scenarios assume that life itself arrived on earth from extraterrestrial sources (a phenomenon called ***Panspermia***). Other models (more amenable to experimental test) suggest either that prebiotic organic molecules came from ***extraterrestrial*** sources, or that they formed in more localized favorable ***terrestrial*** environments.

A. Panspermia – an Extraterrestrial Origin of Earthly Life

Panspermia posits that life itself was delivered to our planet on comets or meteorites. Since these are unlikely to have sustained life in space, they must have been a kind of interstellar ‘mailbox’ into which dormant life forms were deposited. The cells in the mailboxes must have been *cryptobiotic*. Examples of cryptobiotic organisms exist today (for example, bacterial spores and even brine shrimp!). Once delivered to earth’s more life-friendly environment, organisms would emerge from their dormant state, eventually populating the planet. There is however, no evidence of dormant or cryptobiotic life on comets or meteorites, and no hard evidence to support *Panspermia*. On the other hand, there is evidence that is at least consistent with an extraterrestrial source of organic molecules, and plenty to support more terrestrial origins of life. In any case, notions of *Panspermia* (and even extraterrestrial sources of organic molecules) just beg the question of the conditions that would have led to the origin of life elsewhere.

While panspermia is not a favored scenario, it is nevertheless intriguing since it is in line with hypotheses that organic molecules may have formed soon after the *Big Bang*. And

if ready-made organic molecules and water were available, we can expect (and many do!) that there is life on other planets. This expectation has generated enough excitement to stimulate serious discussion and serious funding of programs looking for signs of life on other planets. For example, NASA funded Rover's search and discovery of signs of water on Mars, and even supported the more earth-bound *Search for Extraterrestrial Intelligence* (the SETI program) on the grounds that life not only exists elsewhere, but that it evolved high level communication skills! For a fascinating story about meteorites from Mars that contain water and are worth more than gold, look at the *Martian Obsession* article at: <http://science.sciencemag.org/content/346/6213/1044.full>!

B. Extraterrestrial Origins of Organic molecules

Could organic molecules actually have arrived on earth from outer space? They are abundant, for example in *interstellar clouds*, and could have become part of the earth as the planet formed around 4.8 billion years ago, suggesting that there was no need to create them *de novo*. One hypothesis suggests meteorites, comets and asteroids, known to contain organic molecules, brought them here during fiery impacts on our planet. Comet and meteorite bombardments would have been common 3.8 or more billion years ago. In this scenario the question of how (*not* on earth!) free energy and inorganic molecular precursors reacted to form organic molecules is moot!

A related hypothesis suggests that those fiery hits themselves provided the free energy necessary to synthesize the organic molecules from inorganic ones... a *synthesis-on-arrival* scenario. With this hypothesis, we are back to an organic oceanic primordial soup. But some have suggested that organic molecules produced in this way (not to mention any primordial life forms) would likely have been destroyed by the same ongoing impacts by extraterrestrial bodies; witness the (relatively recent!) dinosaur extinction by an asteroid impact off the coast of Mexico some 65.5 million years ago.

C. Organic Molecular Origins Closer to Home

Deep in the oceans far from the rampant free energy and meteoric bombardment of an oxygen-free and ozone-less sky, deep-sea hydrothermal vents would have been spewing reducing molecules (e.g., H₂S, H₂, NH₄, CH₄), much as they do today. Some vents are also high in metals such as lead, iron, nickel, zinc copper, etc. When combined with their clay or crustal substrata, these minerals could have provided unique surfaces for the catalytic enhancement of organic molecule synthesis. Could such localized conditions have been the focus of prebiotic chemical experimentation leading to the origins of life? Let's look at two kinds of deep sea hydrothermal vents recognized today: *volcanic* and *alkaline*.

1. *Origins in a High-Heat Hydrothermal Vent*

The free energy available from a volcanic hydrothermal vent would come from the high heat (temperatures ranging to 350°C) and the minerals and chemicals expelled from the earth's mantle. An example of a volcanic hydrothermal vent is illustrated below.

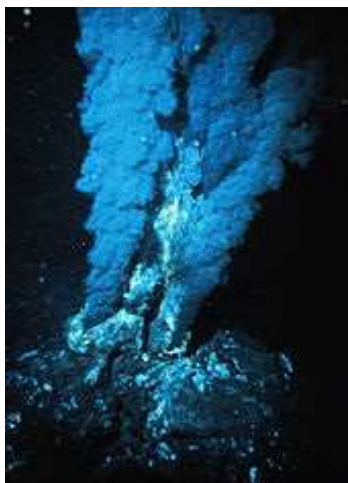

From: <http://www.photolib.noaa.gov/htmls/nur04506.htm>

Conditions assumed for prebiotic volcanic hydrothermal vents could have supported catalytic syntheses of organic molecules from inorganic precursors (see [Volcanic Vents and organic molecule formation](#)). The catalysts would have been metal (nickel, iron...) minerals. Chemical reactions tested include some that are reminiscent of biochemical reactions in chemoautotrophic cells alive today. Günter Wächtershäuser proposed the [iron-sulfur world theory](#) of life's origins in these vents, also called "black smokers". These vents now spew large amounts of CH₄ and NH₄, and experiments support the idea that iron-sulfur aggregates in and around *black smokers* could have provided catalytic mineral surfaces for the prebiotic formation of organic molecules like methanol and formic acid from dissolved CO₂, CH₄ and NH₄. Wächtershäuser also suggested that prebiotic selection acted not so much on isolated chemical reactions, but on aggregates of *metabolic reactions*. We might think of these *aggregates* as biochemical pathways or multiple integrated pathways. He proposed selection of cyclic chemical reactions that released free energy usable by other reactions. This prebiotic **metabolic evolution** of reaction chemistries (rather than a simpler chemical evolution) would have been essential to the origins of life. In fact, a variety of extremophiles (e.g., thermophilic archaea) now live in and around *black smokers*.

But there are problems with a life-origins scenario in volcanic hydrothermal vents. For one thing, that their high temperatures would have destroyed as many organic molecules as were created. Also, the extremophilic archaea now found around these volcanic vents cannot be the direct descendants of any cells that might have originated there. Woese's phylogeny clearly shows that archaea share a lineage with eukaryotes (not Bacteria - see above). Therefore, extremophilic cellular life originating in the vents must have first have given rise to a more moderate LUCA before then dying off themselves... after which extremophiles would once again evolve independently to re-colonize the vents! This mitigates against an extremophiles-first origins scenario. Given these concerns, recent proposals focus on life origins in less extreme ***alkaline hydrothermal vents***.

2. ***Origins in an Alkaline Deep-Sea Vent***

One of the more satisfying alternatives to a soupy origin of heterotrophic cells is the origins of autotrophic life in *alkaline vents*. For starters, at temperatures closer to 100 °C -150°C, alkaline vents (***white smokers***) are not nearly as hot as black smokers. An *alkaline vent* is shown below.

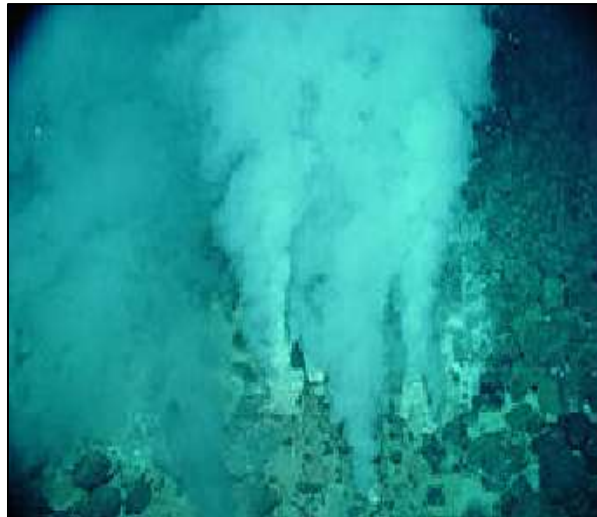

From: http://oceanexplorer.noaa.gov/explorations/04fire/logs/hirez/champagne_vent_hirez.jpg

Other chemical and physical conditions of alkaline vents are also consistent with an origins-of-life scenario dependent on *metabolic evolution*. For one thing, the interface of with alkaline vents with acidic ocean waters has the theoretic potential to generate many different organic molecules [Shock E, Canovas P. (2010) *The potential for abiotic organic synthesis and biosynthesis at seafloor hydrothermal systems*. Geofluids 10 (1-2):161-92)].

In laboratory simulations of alkaline vent conditions, the presence of dissolved CO₂ favors **serpentinization**, a reaction of water and heat with *serpentinite* (an iron-containing mineral found on land and in the oceanic crust). A sample of serpentinite polished to make a countertop (!) is shown below.



In serpentinization, a mineral called *olivine* [(Mg⁺², Fe⁺²)₂SiO₄] reacts with dissolved CO₂ to form methane (CH₄). Other reactions involving serpentinite involve a warm aqueous oxidation of iron that could account for abundant H₂ in the *white smoker* emissions. Various other hydrocarbon gases may have also been produced by *serpentinization*. So the first precondition of life, the energetically favorable creation of organic molecules, is possible in alkaline vents. Let's now consider an intriguing proposal for the metabolic origins of life at that acid/alkaline interface of vent and ocean.

The proponents of cellular origins in a late-Hadean non-reducing ocean recognize that organic molecules from an alkaline, or any vent would quickly disperse into ocean waters. Furthermore, the alkaline emissions from the vent would be rapidly neutralized in the wider acidic oceans. Without a nutrient-rich organic soup there would be no selective force for the origins of heterotrophic cellular metabolism. What then, were the thermodynamic conditions in an alkaline vent that could have led to cellular life and what kinds of cells would have formed?

The porous rock structure of today's alkaline vents provide micro-spaces or micro-compartments that might have captured alkaline liquids emitted by *white smokers*. And it turns out that conditions in today's alkaline vents support the formation of hydrocarbon **biofilms**. Micro-compartments lined with such biofilms could have formed a primitive prebiotic membrane against a rocky "cell wall", within which alkaline waters would be trapped. The result would be a natural *proton gradient* between the alkaline solutions of organic molecules trapped in the micro-compartments and the surrounding acidic ocean waters. Did all this happen?

The issue is that there was probably no primordial soup. Without a nutrient-rich environment, **heterotrophs-first** not an option. If as seems likely, the only option left is an **autotrophs-first** scenario for the origins of life. Nick Lane and his coworkers (<http://www.nick-lane.net/LAM%20BioEssays.pdf>) proposed that proton gradients are indeed the selective force behind the evolution of early metabolic chemistries in the alkaline vent scenario. Organized around biofilm compartments, prebiotic structures and chemistries would have harnessed the free energy of the natural proton gradients. In other words, the first protocells, and then cells, would likely have been **chemoautotrophs**.

Life-origins in a non-reducing (and oxygen-free) atmosphere raises additional questions. Were proton gradients a source of free energy sufficient to fuel and organize life's origins? How did cells arising from prebiotic chemiosmotic metabolism actually harness the energy of a proton gradient? Did such first cells begin life with an *ATP synthase* that transduced gradient free energy into the chemical free energy of ATP? Or did they at first couple relief of the gradient to the synthesis of thioester linkages (e.g., acetyl-S-CoA) or other high energy intermediate compounds? Regardless of how proton gradient free energy was initially captured, a proton-pumping **chemoautotrophic LUCA** must have used membrane-bound pumps and an ATPase to harness gradient free energy to make ATP, since *all* of its descendants do so. Later on, how did cells formed in alkaline vents escape the vents to colonize the rest of the planet? Finally, when did **photoautotrophy** (and specifically oxygenic photoautotrophy) evolve? Was it a late evolutionary event? Or did photosynthetic cells evolve quite early among some of the chemoautotrophic denizens of the white smokers, biding their time before exploding on the scene to create our oxygenic environment?

In the alkaline vent scenario, chemiosmotic metabolism predated life. Therefore the first chemoautotrophs did not need the fermentative reactions that would have been required by a heterotrophs-first origin scenario. Even though all cells alive today incorporate a form of glycolytic metabolism, *glycolysis may not be the oldest known biochemical pathway*, as we have thought for so long.

In support of the late evolution of glycolytic enzymes, those of the archaea show little structural resemblance to those of bacteria. If fermentative heterotrophy was a late evolutionary development, then LUCA and its early descendants lacked a glycolytic pathway. LUCA then must have been one of many 'experimental' autotrophic cells, most likely a chemoautotroph deriving free energy from inorganic chemicals in the environment. To account for heterotrophs in Bacteria, Archaea and Eukaryota, heterotrophy would have had to evolve separately in the two antecedent branches descending from the last universal common ancestor of bacterial, archaeal and eukaryotic organisms. The phylogeny shown below illustrates the *autotrophs-first* scenario.

Adapted from: https://en.wikipedia.org/wiki/Phylogenetic_tree

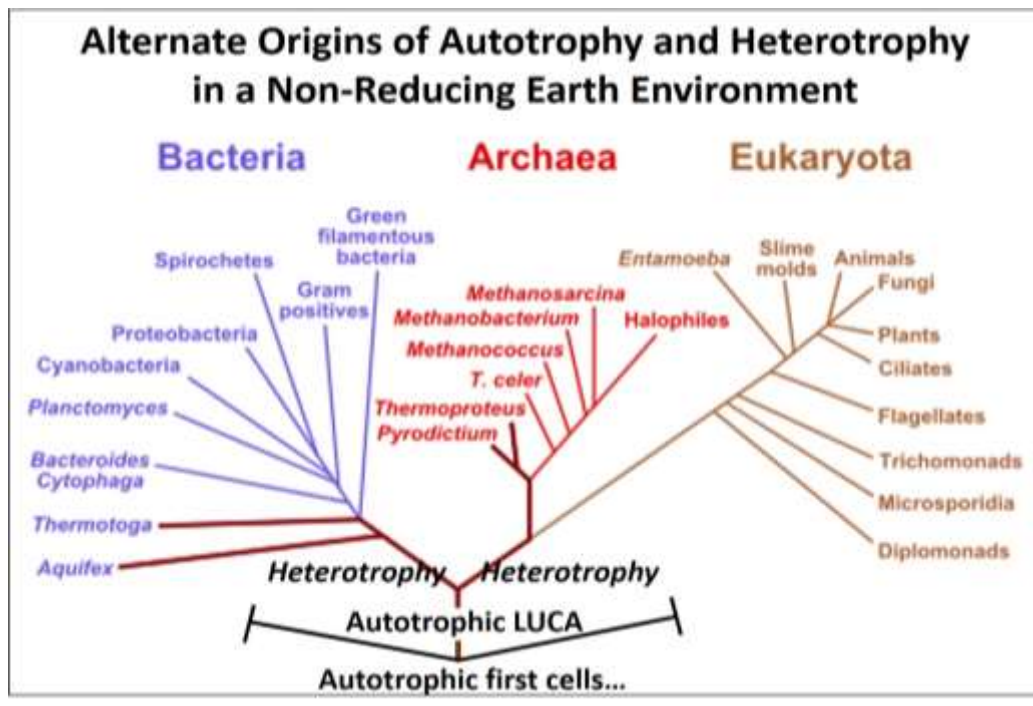

3. A Summing Up

Speculation about life's origins begins by trying to identify a source of free energy with which to make organic molecules. As we have seen, the first cells could have been heterotrophs formed in a reducing earth environment, from which autotrophs later evolved. Alternatively, the earliest cells were autotrophs formed under non-reducing conditions in the absence of a primordial soup..., and only after these autotrophs had produced enough nutrient free energy to sustain them did heterotrophs belatedly emerge.

As we have seen, there are still questions to be answered about life-origins under non-reducing conditions. Even the composition of the prebiotic atmosphere is still in some contention (see [Non-reducing earth-Not so fast!](#)). Let's put these concerns aside for a moment and turn to events that get us from the LUCA and its early descendants to the chemistries common to all cells today. The descriptions that follow are educated guesses about pathways taken early on towards the familiar cellularity now on earth. They mainly address the selection of catalytic mechanisms, replicative metabolism, the elaboration of biochemical pathways, and the chemical communication that organized cell function and complexity. We'll see that some of the ideas presented are historically tied to heterotrophs-first origins. But they some version of these explanations is required to get *from non-life to life* and *from the LUCA to life today*.

V. Origins of Polymers and Replication

To get to the first cells, we must return to the trail of prebiotic events that would eventually support cellular origins, including the mobilization of small organic molecules to synthesize macromolecules. In other words, chemical evolution would have selected *efficient* and *reproducible* mechanisms for the synthesis of polymers suitable for life. This requires an early selection of mechanisms of **catalysis** and **replication**. Today we think of these as separate cell functions; nucleic acids store and replicate information while chemical reactions are catalyzed by enzymes.

But in a way, what enzymes and nucleic acids do serve the same basic function! Replication is the faithful reproduction of the information needed to make a cell, while catalysis ensures the redundant production of all other molecules essential to life, including the enzyme catalysts themselves. Put another way, catalyzed *polymer* synthesis is just the replication of the work-horse molecules that accomplish cellular tasks. In turn, what we think of as 'replication' is nothing more than the replication of nucleic acid *information* necessary to faithfully reproduce these work-horse molecules. How might informational and catalytic chemistries have co-evolved? What if prebiotic catalysis and replication were conveniently combined in the same molecule? In fact, life may have originated in a prebiotic **RNA world!** Support for a prebiotic RNA world comes from the fact that

- Some RNAs are **ribozymes** (recall self-splicing introns) and some are part of RNA-protein complexes (**ribonucleoproteins**) with catalytic activity (recall ribosomes, spliceosomes and the secretory signal recognition particle).
- **retroviruses** (e.g., HIV) store their genetic information in *RNA genomes* that may have been integral to the emergence of cellular life.

Even today, not all catalysts are proteins and not all information is DNA. We'll look at the origins of catalysis and replication as concurrent selective prebiotic events.

A. Origins of Organic Polymers

There are several scenarios for the synthesis and replication of polymers. The tidal pool scenario has the feel of 'best-fit' with origins of life in a reducing environment. On the other hand, self-replicating molecules have been demonstrated experimentally, and could have *autocatalyzed* their duplication independent of a reducing environment.

1. The Tidal Pool Scenario

In this scenario, prebiotic organic monomers concentrate in tidal pools in the heat of a primordial day, followed by polymerization by dehydration synthesis. The formation of polymer linkages is an 'uphill' reaction requiring free energy. Very high temperatures (the *heat of baking*) can link monomers by dehydration synthesis and may have done so in tidal pool sediments to form random polymers. This scenario further assumes that the polymers would be dispersed from the tidal pools with the ebb and flow of high tides. The tidal pool scenario is illustrated below.

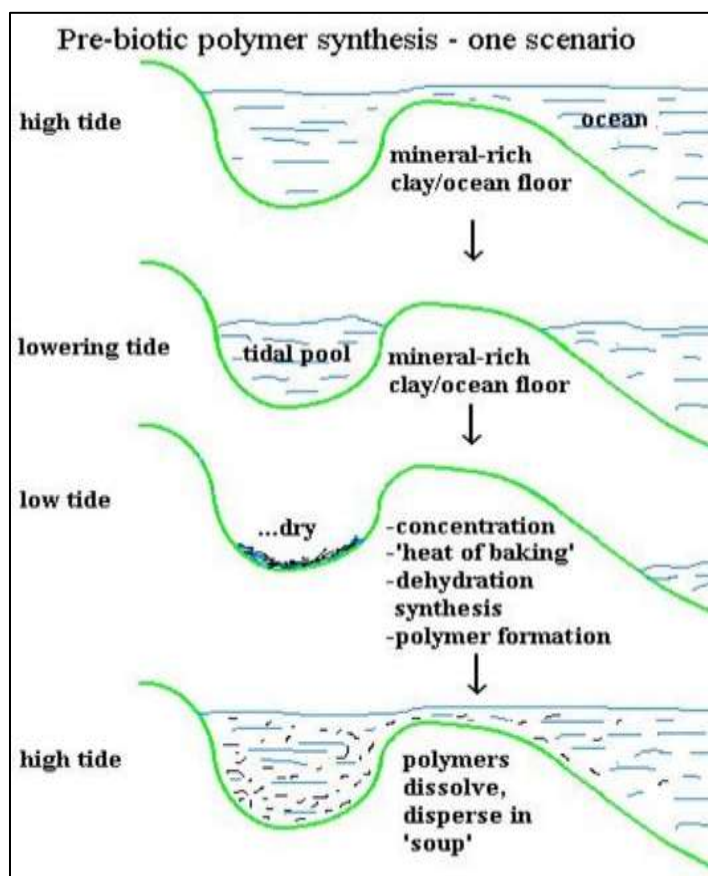

The concentration of putative organic monomers at the bottom of tidal pools may have offered opportunities to catalyze polymerization, even in the absence of very high heat. Many metals (nickel, platinum, silver, even hydrogen) are inorganic catalysts, able to speed up many chemical reactions. Such metals have been found in the sediments of primordial oceans, and mineral aggregates in soils as well as clays can be experimentally shown to possess catalytic properties.

The fact that metals are now an integral part of many enzymes suggests that biological catalysts could indeed have their origins in simpler aggregated mineral catalysts in ocean sediments. Before life, the micro-surfaces of mineral-enriched sediment, if undisturbed, could have been able to repeatedly catalyze the same or at least similar reactions, leading to related sets of polymers. Consider the possibilities for RNA monomers and polymers, based on the assumption that life began in an RNA world. The possibilities are illustrated below.

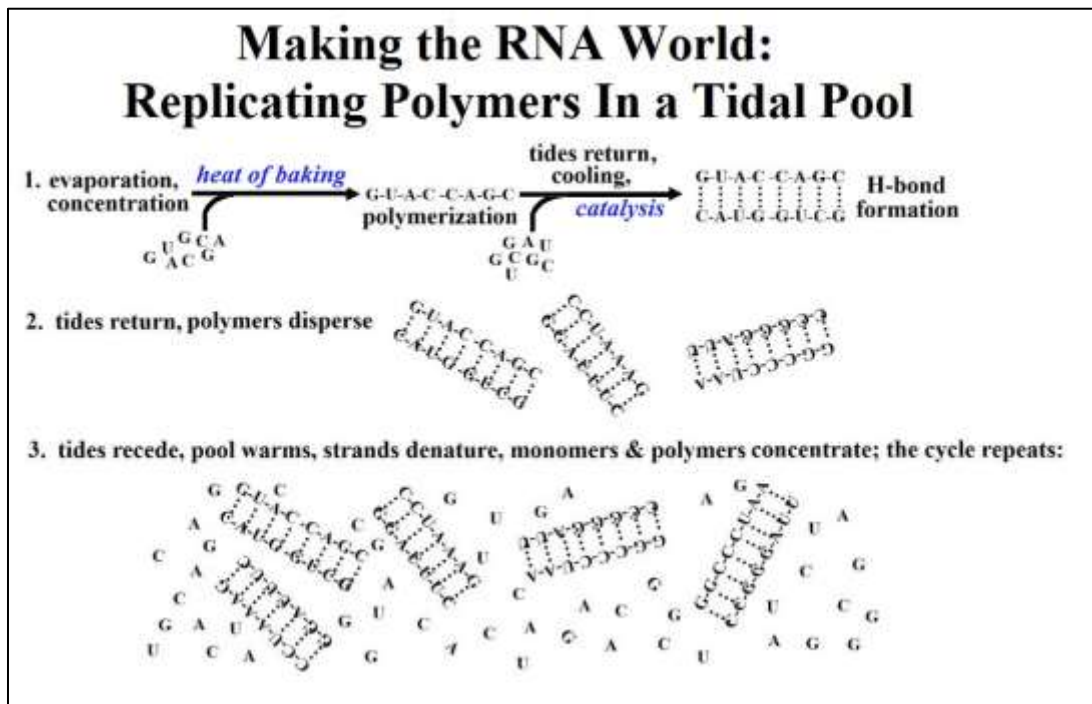

The result predicted here is the formation not only of RNA polymers (perhaps only short ones at first), but of H-bonded double-stranded RNA molecules that might effectively replicate at each cycle of concentration, polymerization and dispersal. Heat and the free energy released by the reactions themselves could have supported polymerization, while catalysis would have enhanced the fidelity of RNA replication.

In the tidal pool scenario, repeated high heat or other physical or chemical attack might degrade the new-formed polymers..., except for some RNA double strands that were more resistant to destruction. If true, then some of the early RNA duplexes would accumulate at the expense of the weaker, more susceptible ones. Only the *fittest* replicated molecules would be selected!

Most likely, it was probably protected metabolic chemistries inside semipermeable compartments (such as biofilm membranes proposed for alkaline vents) that were the real objects of prebiotic selection. Before we consider several other structures that could have aggregated and protected those chemistries behind semipermeable membranes, let's look at another source of catalytic activity that could have participated in creating an RNA world.

2. A Self-Replicating Molecule - an Example of Autocatalysis

There exist molecules that can catalyze their own synthesis; these would be self-replicating **autocatalysts**! Could one of these autocatalysts have been a prebiotic prelude to the RNA world? Amino-adenosine triacid-ester (AATE) is a present-day *autocatalyst*. The structure and replication of AATE is described below (note that it includes a modified purine base).

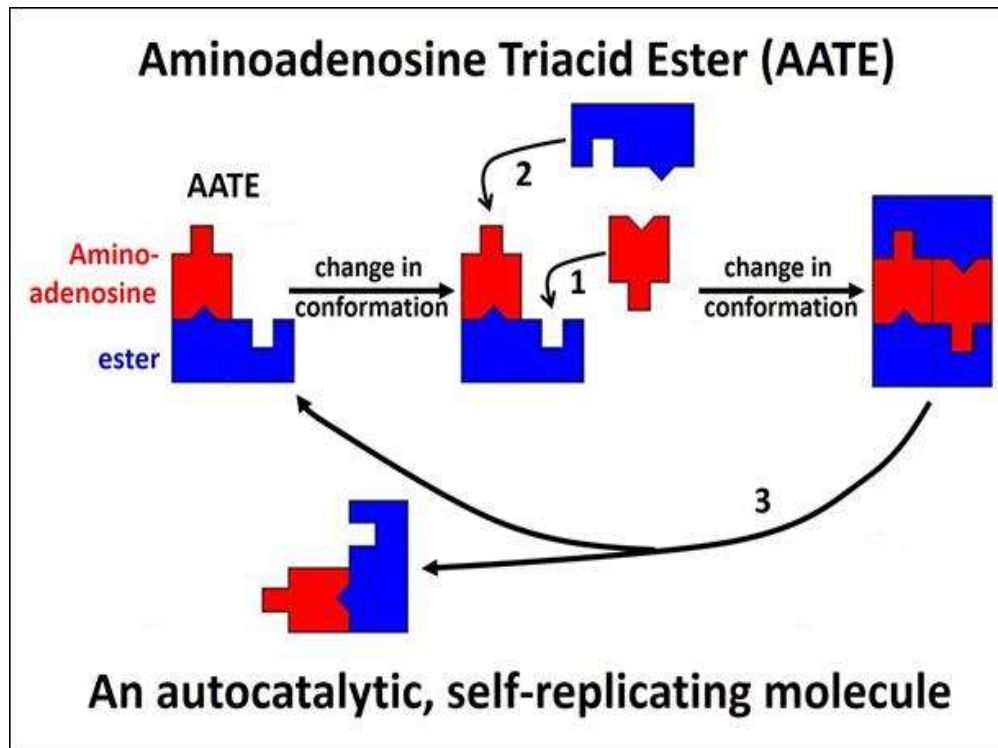

The replicative reaction proceeds in the following steps:

1. The aminoadenosine triacid ester binds another molecule of aminoadenosine.
2. The two aminoadenosines, now in opposite orientations, can attract and bind a second ester.
3. After bond-rearrangements, the molecule separates into two molecules of AATE.

This reaction is catalytic because the stereochemistry of the reacting molecules creates an affinity of the aminoadenosine ester molecule first for an additional free aminoadenosine molecule and then for a second free ester. The structure formed then allows linkage of the second aminoadenosine and ester followed by the separation of both AATE molecules. Subtle, sequential changes in the molecular conformation of the molecules result in the changes in affinities of the molecules for each other,. In the replicative reaction, the concentration of AATE, free ester and free aminoadenosine would drive the reaction.

Could AATE-like molecules have been progenitors of autocatalyzed polymer replication. Could replication of a prebiotic AATE-like molecule have led to an RNA world? To date, experiments with prebiotic chemistries have not produced a self-replicating molecule. But the possibility is all the more intriguing because the 'triacid' includes a nucleotide base!

VI. Molecules Talk: Selecting Molecular Communication and Complexity

The accumulation of structurally related, replicable and stable polymers reflects an environmental chemical **homeostasis** (one of those properties of life!). In our complex human society, we define **communication** by its specificity; without careful choice of words our speech would be mere babel. In chemical terms, chemical selection necessarily favored increasing **specificity** of molecular interactions in a challenging environment, resulting in **molecular communication** and **complexity** (another property of life!). In fact, all of the properties of life must have accompanied the achievement of more and more complex intermolecular communication.

Simply put, a prebiotic (or for that matter a cellular) genetic change that alters the rate of one catalytic reaction (if not destructive) will drive the selection of changes in components of interconnected metabolic chemistries. If **molecular communication** required the evolution of catalytic specificity, then the final elaboration of complexity and order as a property of life further requires the selection of mechanisms of **regulation** and **coordination**.

A. Intermolecular Communication Leads to An Early Establishment of Essential Interconnected Chemistries

We have suggested that precursors to enzymes were probably minerals embedded in clay or other substrata, providing surfaces that naturally aggregated organic molecules and catalyzed repetitive reactions. But the objects of prebiotic selection would be not have been monomers and polymers alone, no matter how stable they were. Selection would have favored polymers that enhanced growth and reproduction of successful aggregates, polymers that could catalyze their own synthesis, perhaps collaborating with inorganic catalytic minerals. The result would be an elaboration of *interconnected chemical reactions* between molecules with high affinity for each other and thus increasing specificity. In the context of life origins and evolution, **co-catalysis** describes the activities of these interconnected metabolic reactions.

High-affinity interactions are inherently **protective**. In a prebiotic world, protected stable metabolic chemistries must have formed or become part of **molecular assemblies** that would be targets of selection during chemical/metabolic evolution. These structural and catalytic assemblies must have been selected early in chemical evolution. Increasing the specificity of molecular interactions results from continuing co-evolution of catalysts, substrates and co-catalytic reaction sets, leading to more and more sophisticated molecular **communication**. Once established, efficient biochemical reaction sets would be constrained against evolutionary change. Any change (mutation) that threatened this efficiency would mean the end of any prebiotic (or for that matter, cell) lineage! This explains why we find the same form of energy-generating (e.g., autotrophic and fermentative), replicative (DNA, RNA, protein synthesis) and chemiosmotic pathways in all of LUCA's descendants. Likewise, the first cells must have used with very similar, organized and efficiently catalyzed metabolic chemistries.

Sophisticated or effective communication, requires **coordination**, the capacity to make *chemical decisions*. Selection of molecular assemblies, or aggregates that sequestered metabolic reaction would ensure that only certain molecules communicate with each other. This sequestration is likely to have occurred repeatedly during chemical evolution, beginning with the synthesis of larger, polymeric molecules and possibly, an aggregation of primitive lipoidal molecules. We can think of increasingly effective catalysis in an enclosed environment as **a conversation mediated by good speakers!** *Coordination* is a property that likely co-evolved with life itself!

B. Origins of Coordination

Let's look the possible structures churning around in the prebiotic chemistry set that might have self-assembled, or sequestered compatible chemistries of life. We have already seen the alkaline vent *biofilm compartment*. **Coacervates**, **proteinoid microspheres** and **liposomes** (below) are structures that can be made in a laboratory, are demonstrably semipermeable, and in that some cases can even replicate!

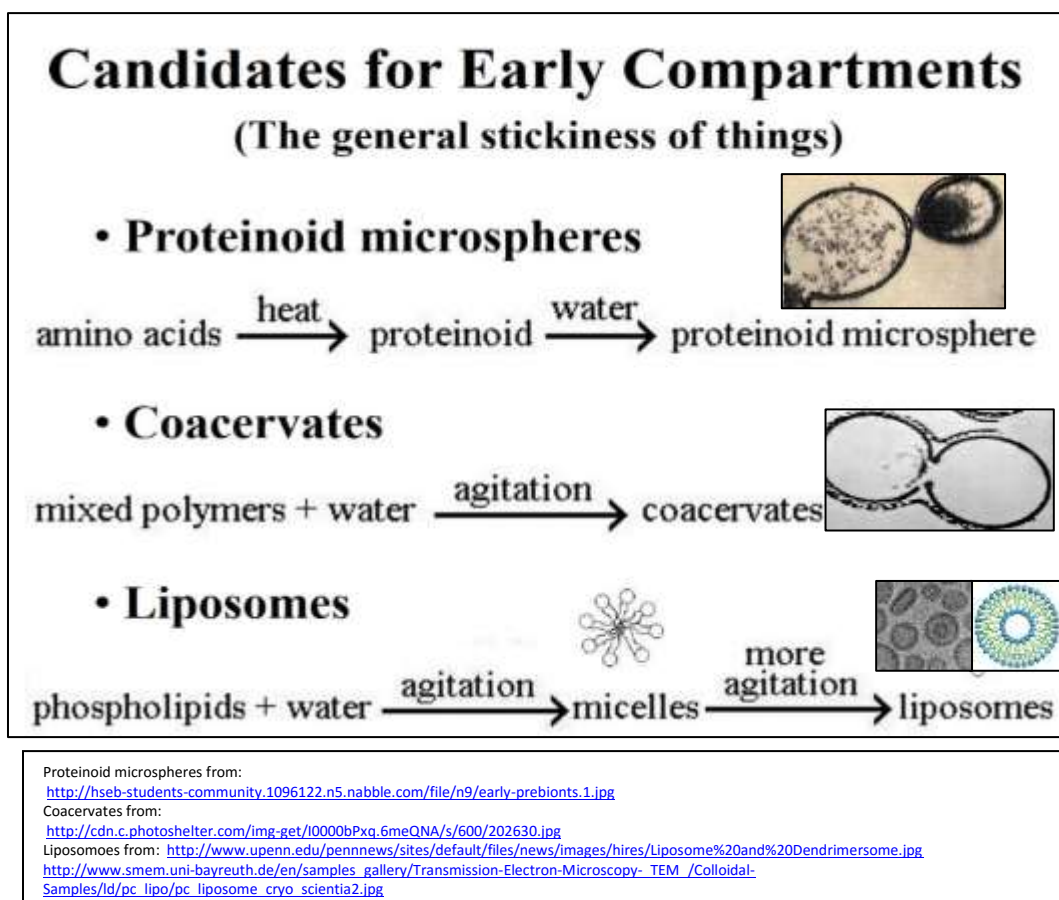

Oparin proposed that the action of sunlight in the absence of oxygen could cause ionized, oppositely charged organic molecules (e.g, amino acids, carbohydrates, etc.) to form droplets from organic molecules in his primordial soup. These **coacervates** were actually produced in 1932, visualized by microscopy and shown to be a semi-permeable compartment. They even behaved as if they were able to grow and reproduce (also as Oparin originally suggested they might).

In the 1950s, Sidney Fox produced **proteinoid microspheres** from short peptides that formed spontaneously from aqueous amino acid solutions heated to dryness (not unlike what happens in the tidal pool scenario of polymer formation from organic monomers). These can be seen by light and electron microscopy.

Liposomes may have been the structure of choice for forming a primitive cell. However, while they can be easily produced under present day conditions, it isn't clear that they existed on a pre-biotic earth. Nevertheless, cellular membranes had acquired their phospholipid bilayer structure by the time of LUCA since they are a feature of all LUCA's descendents. Prior to LUCA, chemical rearrangements must have occurred to enable incorporation of a phospholipid bilayer boundary around cells.

We have already considered the **biofilm** proposed for cellular origins in an alkaline vent, and the resulting separation of acidic ocean protons from the interior of such protocells that could have driven the early evolution of chemiosmosis as a means to create chemical energy, complete with the concurrent 'evolution' of ATP synthases and the enzymes of proton transport, again because all cells descendent from LUCA's possess these biochemistries.

Of course, proteinoid microspheres, coacervates, biofilm-based 'membranes and liposomes are not alive, and are therefore not cells. But one or another of them must have been where an enhanced **coordination of molecular communication** required for life began.

The important **take-home message** here is that whatever the original structure of the first cells, they did arise soon after the organic chemical prerequisites of life began to acquire familiar metabolic functions. We need to see chemical and structural progress to cellularity as concurrent metabolic evolutionary events. At some point, selection of sequestered biochemistries led to **protocells** and then to the first cells, each with all of the properties of life. As we will see now, the first of these biochemistries may have combined more than one essential function of life in a single kind of molecule!

C. Origins of Information Storage and Retrieval in an RNA World

Let's accept that molecular communication began with the packaging of interconnected co-catalytic sets into semipermeable structures. Then the most 'fit' structures were selected for efficient coordination of meaningful, timely chemical messages. Ultimately, coordination requires **information processing, storage and retrieval**. We can't pinpoint a sequence of events by which a protocell acquired this ability. But we can still suggest scenarios that might have led to the Francis Crick's *Central Dogma* of information flow from DNA to RNA to protein.

The Central Dogma, modified to account for reverse transcription and the behavior of retroviruses, is summarized below.

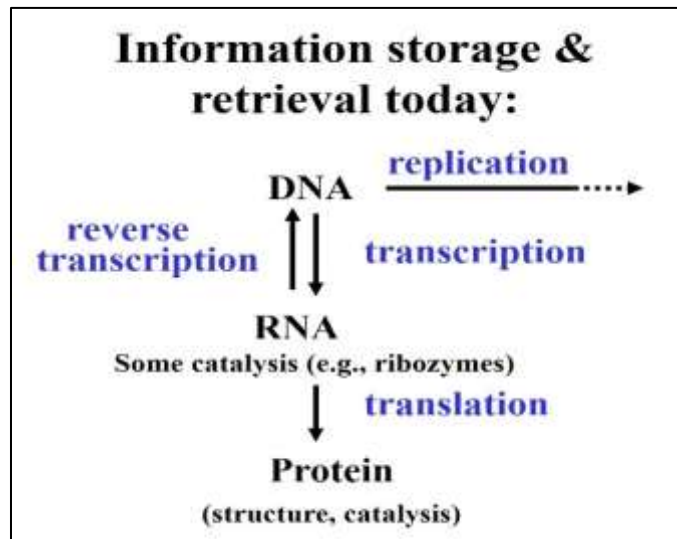

We do not really know how cells came to rely on DNA to store, pass on and mobilize genetic information, but we have presented reasons to believe that the first replicating nucleic acid was RNA, creating the *RNA world* described earlier. Here again is the evidence that leads us to this conclusion.

- Based on the stem-and-loop and other structures that form when RNA molecules undergo internal H-bonding, we know that RNAs can take on varied and intricate shapes.
- Diverse conformations are consistent with the evolution of specificity in the interaction of RNAs with other molecules in a prebiotic environment.
- RNAs, either alone as *autocatalysts* (for example, self-splicing mRNAs) or in catalytic ribonucleoprotein complexes (for example, in ribosomes) exist in cells today.
- Some of these RNAs (specifically rRNAs), have a long phylogenetic heritage, shared by cells in all three domains of life.

The propensity of single stranded RNA molecules to fold based on internal H-bonding can lead to those diverse three-dimensional shapes (tertiary structure). Some of these structures could have interacted with other molecules in a prebiotic environment. Because they could be replicated according to different prebiotic scenarios, these same RNAs could also pass on simple genetic information contained in their base sequences.

This combination of informational and catalytic properties in a single molecule is illustrated below.

RNA: the first information storage molecule

Shape, specificity & catalysis

Today, RNAs called **ribozymes** can catalyze aspects of their own synthesis:

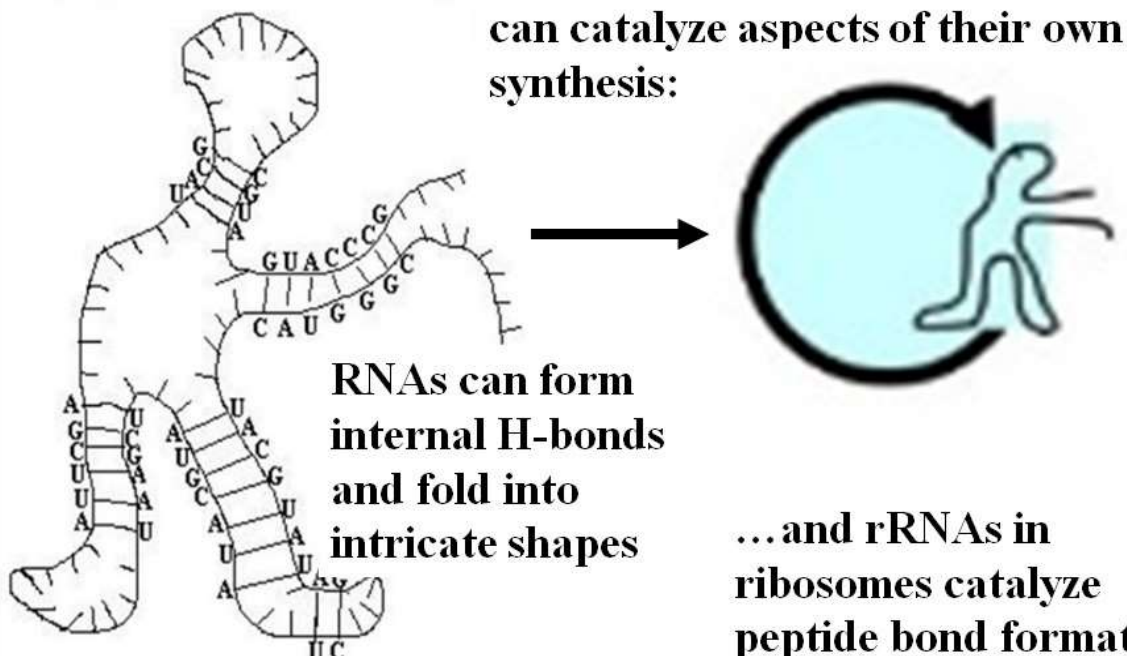

RNAs can form internal H-bonds and fold into intricate shapes

... and rRNAs in ribosomes catalyze peptide bond formation!

The capacity of RNAs as catalysts and warehouses of genetic information cannot be demonstrated for DNA, and speaks to an efficient candidate for the first *dual (multi-) purpose* polymer! You can read more about the proposed 'RNA worlds' in which life may have begun in Cech TR (2012) [*The RNA Worlds in Context*. In *Cold Spring Harbor Perspectives in Biology* (Cold Spring Harbor, NY: Cold Spring Harbor press) 4(7):a006742e].

What might RNA catalysis beyond self-replication have looked like in simpler times?

Consider the interaction between a two hypothetical RNAs and different hypothetical amino acids bound to each, shown below.

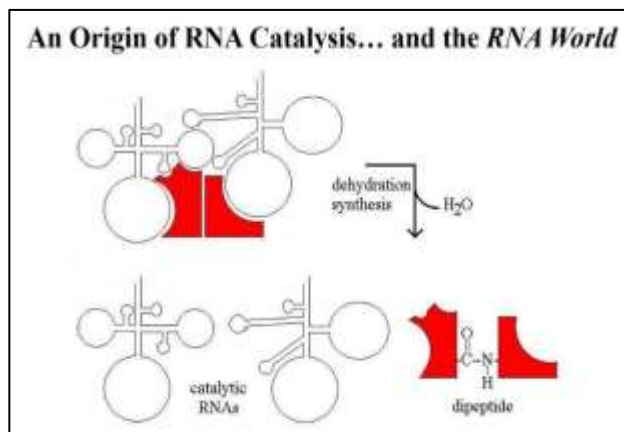

The binding of each RNA to its amino acid would be a high affinity, specific interaction based on charge and shape complementarity. Likewise, the two RNAs have a high affinity for each other based on similar chemical and physical complementarities. One can even envision some strong H-bonding between bases in the two RNAs that might displace intra-strand H-bonding (not shown here). The result is that the two amino acids are brought together in such a way that catalyzes peptide bond formation. This will require an input of free energy (recall that peptide bond is one of the most energy intensive reaction in cells). For now let's assume an energy source and focus on the specificities required for RNA catalytic activity.

We know that tRNAs are now the intermediaries between nucleic acids and polypeptide synthesis. So we can ask if the kind of activity in the illustration above could have led to tRNA-amino acid interactions we see today. There is no obvious binding chemistry between today's amino acids and RNAs, but there may be a less obvious legacy of the bindings proposed in the illustration above. This has to do with the fact that the genetic code is universal, which means that any structural relationship between RNA and amino acids must have been selected early (at the start!) of cellular life on earth. Here is the argument.

1. The code is indeed universal (or nearly so)
2. There is a correlation between the chemical properties of amino acids and their codons, for example:
 - Charged (polar) amino acids are encoded by triplet codons with more G (guanine) bases.
 - Codons for uncharged amino acids more often contain a middle U (uracil) base.

These correlations would mean that early binding of amino acids to specifically folded RNAs was replaced in evolution by enzyme-catalyzed covalent attachment of the amino acid to the 'correct' tRNAs we see today. We might imagine a separation of the template function of RNAs from most of their catalytic activities driven by the selection of polypeptides because a string of 20 different amino acids provides for much greater diversity of structure (i.e., shape and function) than folded RNAs. That would in turn accelerate the pace of chemical (and ultimately cellular) evolution. A transition from self-replicating RNA events that might have been a precursor to the translation of proteins from mRNAs is illustrated here.

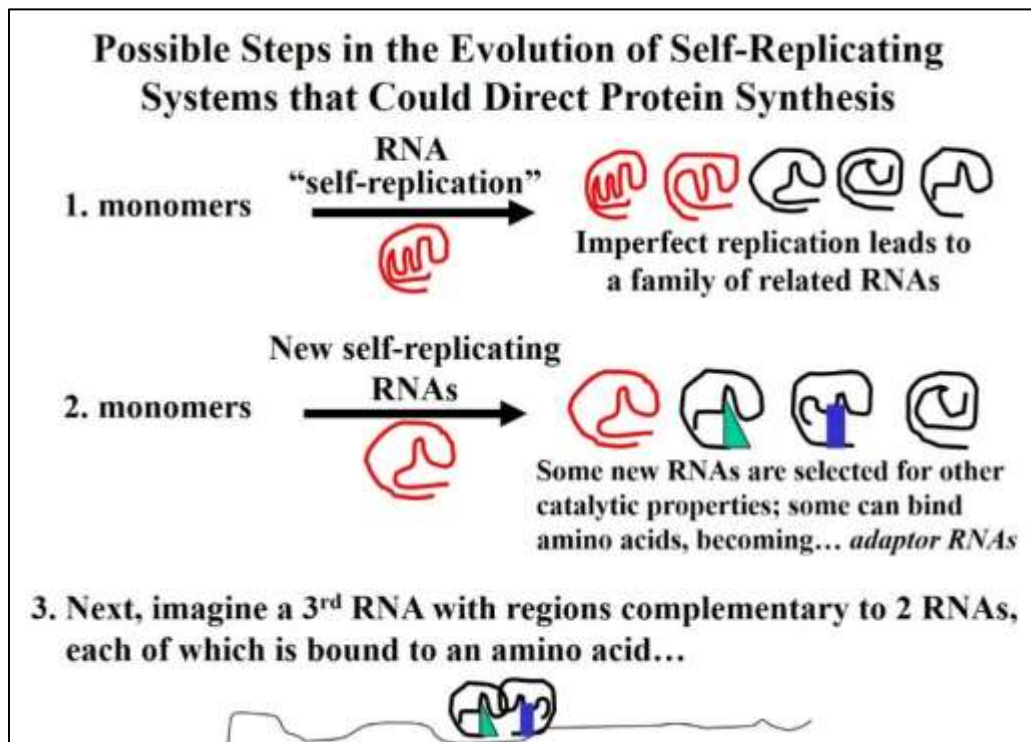

The RNAs referred to as **adaptor** RNAs in the illustration will become tRNAs; the novel, relatively unfolded RNA depicts a presumptive mRNA. Thus, even before the entry of DNA into our RNA world, it is possible to imagine the selection of the defining features of the genetic code and mechanism of translation (protein synthesis) that characterizes all life on the planet.

Next, we consider "best-speculations" of how RNA-based information storage and catalytic chemistries might have made the evolutionary transition to DNA-based information storage and predominantly protein based enzyme catalysis.

D. From Ribozymes to Enzymes; From RNA to DNA

The term *co-catalysis* could very well describe biochemical reactions in which a catalyst accelerates a chemical reaction whose product feeds back in some way on its own synthesis. We saw this in action when we discussed enzyme regulation and the control of biochemical pathways. Catalytic feedback loops must have been key events in the evolution of the *intermolecular communication* and *metabolic coordination* required for life. Here we'll consider some scenarios for the evolutionary transition from the RNA catalysis, information storage and replication combined in RNA into something more recognizable as today's nucleic acid information storage and protein-based catalytic metabolism.

1. Ribozymes Branch Out: Replication, Transcription and Translation

RNAs may have catalyzed their own replication, an autocatalytic process much like the AATE in a test tube. At the same time, some RNAs may also have attracted amino acids to their surfaces and catalyzed peptide bond formation, as already described. Shapely prebiotic RNAs may therefore have catalyzed synthesized the peptides... that would eventually take over catalysis of RNA synthesis! The scenario is summarized below.

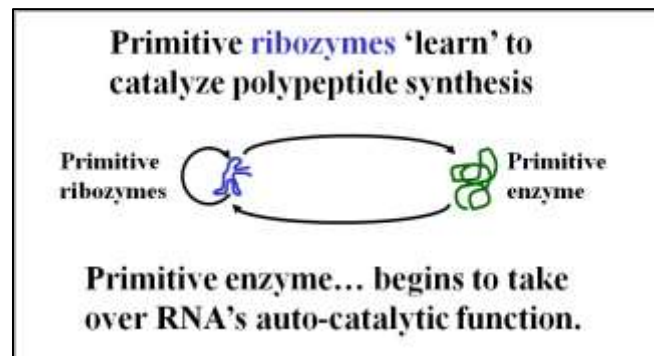

Selection favoring the synthesis of short oligopeptides and polypeptides is consistent with a catalytic diversification that led to the dominance of protein catalysts, i.e., enzymes. The primitive enzyme shown here must have been selected because it assisted autocatalytic replication of the RNA itself! Over time, the enzyme could evolve along with the RNA, eventually replacing autocatalytic RNA replication with the enzyme-catalyzed RNA synthesis we recognize as transcription today. Thus ribozymes are just the vestiges of the RNA world!

Let's turn now to some ideas about how early metabolism in an RNA world could make the transition to the DNA-RNA-protein world we have today.

2. Transfer of Information Storage from RNA to DNA

The transfer of function from RNA to DNA is by no means a settled issue among students of life origins and early evolution. A best guess is that the elaboration of protein enzymes begun in the RNA world would lead to reverse transcriptase-like enzyme that copied RNA information into DNA molecules. DNA information may have been selected because DNA is more stable than RNA. The basic transfer scenario is illustrated below.

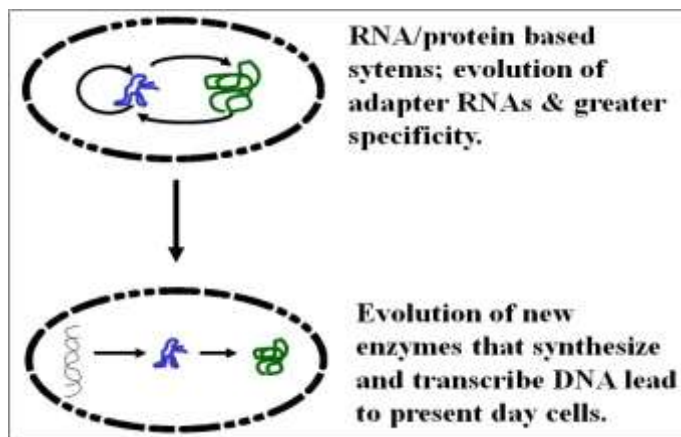

Since all cells alive today store information in DNA (only some viruses have an RNA genome), the role of DNA as an information molecule must have preceded the origin of life..., or must have occurred in the cells from which the LUCA arose. The basics of the transition from the RNA world to information storage and replication represents a series of evolutionary steps yet to be worked out to everyone's satisfaction!

E. The Evolution of Biochemical Pathways

The tale of the evolution of enzymes from ribozymes and of informational DNA from RNA, and other metabolic chemistries behind prebiotic semipermeable boundaries is ongoing in cells today. Undoubtedly, early cellular metabolism involved only reactions crucial to life. The evolutionary trend is inexorably towards greater complexity of molecular communication and coordination..., in other words, towards increasingly refined regulation of metabolism. Whether in cells or in prebiotic structures, we can hypothesize how a new chemical reaction could evolve. For example, assume that a cell requires molecule **D** for an essential function which it acquires from an external, environmental source. What happens if levels of **D** in the environment become *limiting*?

As illustrated below, cells would die without enough **D**. Only cells that already have the ability to make **D** in the cell could survive.

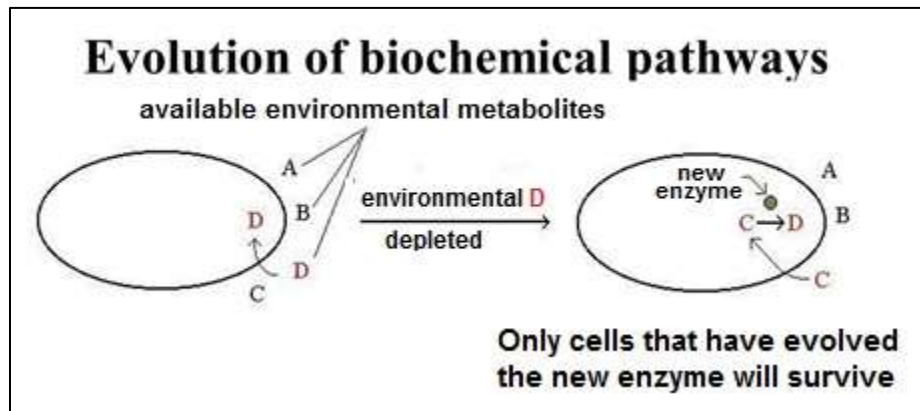

Challenge Question: Using the illustration above as a guide, draw the steps leading to the evolution of a biochemical pathway converting **A** to **B** and **B** to **C**. Explain what you assume in each step of your drawing.

In another scenario, cells are using **A** sourced from the environment, but a mutation results in enzyme activity that can convert **A** to **B**. Here, **B** is not present in the environment to begin. This scenario is illustrated below.

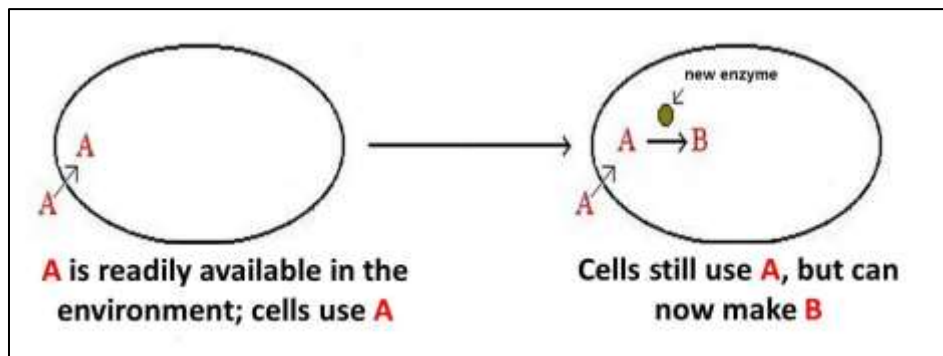

VII. A Summary and Some Conclusions

Our consideration of how life began on earth was intentionally placed at the end of this textbook, after we tried to get a handle on how cells work. Clearly any understanding life's origin scenarios is very much a matter of informed, if divergent speculations. The different, sometimes opposing notions for the life's origins entertained here all address events that presaged life under 'best-guess' hypothetical conditions. After trying to get a grip on prebiotic events, we asked how we got from what could have happened under a given set of prebiotic conditions to the cellular life we recognize today. All proposals recognize that the first cells had all of the properties of life. Starting with that common understanding, all arguable scenarios try to navigate pathways from primitive, less controlled chemistries to more regulated and coordinated metabolisms, in other words from chemical simplicity to biochemical complexity. Chemical and metabolic evolution begun in before life often overlaps in time with cellular evolution, at least until the LUCA. This universal common ancestor had already escaped the RNA world, replicating DNA, transcribing RNA and translating mRNAs into polypeptides, all behind a semipermeable phospholipid bilayer. Whether a heterotroph or (increasingly more likely) an autotroph, LUCA uses the energy of ATP to power all of its cellular work, as do its descendants. Cellular evolution after the LUCA is focused on continued selection of the complexities of metabolism that enables the spread of life from wherever it started.

Challenge Question: The link below will take you to part of an interview in 2016 with Stephen Hawking, the famous astrophysicist.

[Stephen Hawking on the Evolution of Artificial Intelligence](#)

In the interview, Hawking worries that when artificial intelligence matures (presumably in computers or other more 'hands-on' devices), it/they will be able to evolve. What do you think this means to Hawking? Or, alternatively, what do you think it might mean if, as I have suggested, evolution is the *prime directive* of living things?

Cellular evolution after the LUCA focused on selection of the complexities of metabolism that enables the spread of life from wherever it started. Selection by new circumstance from among random, originally neutral genetic changes continue to this day, leading to diversity of species. The overall take-home message of this chapter should be an understanding of the molecular basis of evolution that can help us understand how life may have begun on earth (or anywhere for that matter!). In turn, speculation about life's origins must inform us about how the properties of life were selected under a set of prebiotic physical and chemical conditions.

List of Videos on Youtube

Recorded Voice-Over PowerPoint (VOP) Lectures

- 1 [Cell Tour Part 1](#)
- 2 [Cell Tour Part 2](#)
- 3 [Life's Properties, Origins & Evolution](#)
- 4 [Techniques for Studying Cells](#)
- 5 [Chemistry and the Molecules of Life](#)
- 6 [Biochemistry Part1: Carbohydrates, Lipids & Proteins](#)
- 7 [Biochemistry Part 2: DNA, RNA, Macromolecular Assembly](#)
- 8 [Proteins: Structure & Function](#)
- 9 [Proteins: How We Study Them](#)
- 10 [Bioenergetics Part 1](#)
- 11 [Bioenergetics Part 2](#)
- 12 [Enzymes: Catalysis](#)
- 13 [Enzymes: Kinetics Part 1](#)
- 14 [Enzymes: Kinetics Part 2](#)
- 15 [Glycolysis: Stage 1](#)
- 16 [Glycolysis: Stage 2](#)
- 17 [Glycolysis & Gluconeogenesis: How the Atkins Diet Works](#)
- 18 [Respiration: The Krebs Cycle](#)
- 19 [Respiration: Electron Transport](#)
- 20 [Respiration: Oxidative Phosphorylation](#)
- 21 [DNA -The Stuff of Genes](#)
- 22 [DNA Structure](#)
- 23 [DNA & Chromosomes](#)
- 24 [DNA & Chromatin](#)
- 25 [DNA Replication Part 1](#)
- 26 [DNA Replication Part 2](#)
- 27 [RNA: Overview of Transcription](#)
- 28 [RNA: Transcription & Processing Part 1](#)
- 29 [RNA: Transcription & RNA Processing Part 2](#)
- 30 [RNA Translation: The Genetic Code](#)
- 31 [Translation: Initiation](#)
- 32 [Translation: Elongation](#)
- 33 [Translation: Termination](#)
- 34 [Gene Regulation in Prokaryotes](#)
- 35 [Gene Regulation in Eukaryotes](#)
- 36 [Gene Activity & Chromatin](#)

- 37 [Gene Activity: Epigenetic Inheritance](#)
- 38 [Gene Activity: Post-Transcriptional Regulation](#)
- 39 [DNA Technologies: cDNA Libraries](#)
- 40 [DNA Technologies: DNA Sequencing](#)
- 41 [DNA Technologies: Genomic Libraries](#)
- 42 [DNA Technologies: The Polymerase Chain Reaction \(PCR\)](#)
- 43 [DNA Technologies: Microarrays](#)
- 44 [Membranes: Basic Structure](#)
- 45 [Membranes: Structure of Membrane Proteins](#)
- 46 [Membranes: Transport](#)
- 47 [Membranes: Potential and Excitation](#)
- 48 [Membranes: Directing Protein Traffic in Cells](#)
- 49 [Membranes: Cell-Cell Communication, the Cell Surface and Cell Junctions](#)
- 50 [Membranes: Intercellular Communication & Signal Transduction](#)
- 51 [Cytoskeleton- Microtubules, Microfilaments, Intermediate Filaments](#)
- 52 [Cytoskeleton: Actin, Myosin & the Muscle Contraction Paradox](#)
- 53 [Cytoskeleton: Resolving the Actin-Myosin Muscle Contraction Paradox](#)
- 54 [Cytoskeleton: Regulation of Skeletal Muscle Contraction](#)
- 55 [Cell Division: Discovery of the Cell Cycle](#)
[Cell Division: Cyclins, MPF, Apoptosis, Cell Cycle Checkpoints](#)

Videos Embedded in the iText

http://youtu.be/Bw23E7e0YNk	<i>ID EM Nuclei</i>
http://youtu.be/oZX1H0X7xQY	<i>Phase Contrast Micrograph of Isolated Chloroplasts</i>
http://youtu.be/g6Ra9_c2laQ	<i>Polar H₂O</i>
http://youtu.be/qPgZnmVFv8g	<i>Thermodynamic Laws</i>
http://youtu.be/27B0D1uf8GM	<i>Enthalpy</i>
http://youtu.be/cpps2CZ0aA4	<i>Calorimetry</i>
http://youtu.be/BCsGqmO35BY	<i>Calorimeter Experiment</i>
http://youtu.be/gKSFLTyyzEI	<i>Reduction Potentials...</i>
http://youtu.be/PwLbYYyudZA	<i>Electron Flow in ET...</i>
http://youtu.be/BLEB0A_9Tt4	<i>PSI Photosynthesis Clip</i>
http://youtu.be/t4RIsDDsNi8	<i>Z Scheme of Photosynthesis</i>
http://youtu.be/T6HfiwC0eul	<i>Cyclic Photophosphorylation</i>
http://youtu.be/XtzExh3I17c	<i>Dark Reactions of Photosynthesis</i>
http://youtu.be/p_c7VJvqEbo	<i>Prescott Experiment</i>
http://youtu.be/51sT-3YU9yk	<i>Semicon Replication...</i>
http://youtu.be/29gFdfhtmYk	<i>E. coli Replication Initiation</i>
http://youtu.be/_c_JCjYrTZM	<i>Eukaryotic Replicons in S Phase</i>
http://youtu.be/xdm4UpixaLU	<i>Telomerase Action</i>
http://youtu.be/ThMSitggND0	<i>Processive Replication</i>
http://youtu.be/UN56se_-yfY	<i>snRNPs and mRNA Splicing</i>
http://youtu.be/jpHSgq1MlPq	<i>rRNA Ribosome Assembly and Export</i>
http://youtu.be/0m-PXfWWxNA	<i>mRNA-30S Subunit Association</i>
http://youtu.be/21C01D2Tgeq	<i>miRNAs</i>
http://youtu.be/BTAi3RoSkV0W	<i>siRNA Pathway</i>
http://youtu.be/KoU9y3W3wsk	<i>Translation Initiation Complex Formation</i>
http://youtu.be/swy_qV6_Fb8	<i>Translation Elongation</i>
http://youtu.be/YN3qUL5svnQ	<i>lac Operon Transcription & Translation</i>
http://youtu.be/RKf66-VzYI0	<i>Basic lac Operon Transcription</i>
http://youtu.be/MNQ8CzhDfCg	<i>lac Operon Derepression</i>
http://youtu.be/G590s9xZ9VA	<i>Transcription Regulation by Steroid Hormones</i>
http://youtu.be/CSvNSm7pgyc	<i>Signal Transduction Pathways</i>
http://youtu.be/Hp00FPV62y0	<i>Translational Control of Globin Gene Expression by Hemin</i>
http://youtu.be/_g-DQq4XDfw	<i>Proteasome-Ubiquitin Action</i>
http://youtu.be/_z-ydn718yM	<i>Make Recombinant Plasmids-Transform Bacteria</i>
http://youtu.be/nemMygDhMLc	<i>Replica Plating to Identify Recombinant Clones</i>
http://youtu.be/KgNjHunG79M	<i>Restriction Map Experiment</i>
http://youtu.be/9Qp3Ff90K_A	<i>Microarray Question</i>
http://youtu.be/p2zxwQl8n9s	<i>Microarray Robotics</i>
http://youtu.be/oGsET23q-e0	<i>Demonstrating a Fluid Mosaic Membrane</i>
http://youtu.be/TkHNC8ePMPE	<i>Making Cell Surface Glycoproteins</i>
http://youtu.be/1PPz5kzOChg	<i>Diffusion Across Membranes</i>
http://youtu.be/OEFUvF56deU	<i>Glucose Transport vs. Symport</i>
http://youtu.be/SXL1RBK3Rm8	<i>Facilitated Diffusion</i>

http://youtu.be/-xZvya2Gt50	<i>[Na⁺][K⁺] Pump</i>
http://youtu.be/BLvXIoKh8ul	<i>Propagation of an Action Potential</i>
http://youtu.be/tSks9WPDxHM	<i>Ion Channels in Neurotransmission</i>
http://youtu.be/ggkwaqly-ROE	<i>Channel States in an Action Potential</i>
http://youtu.be/SIM6U0Y6BxQ	<i>Endomembranes in Action</i>
http://youtu.be/csQ_-e92C-Q	<i>COPs and SNARES</i>
http://youtu.be/vgZHF_Ju-PQ	<i>Importing Proteins to Nucleus</i>
http://youtu.be/cTlu79rhJYs	<i>Mitochondrial Protein Import</i>
http://youtu.be/Se9N5sKmYcE	<i>G-Protein Signaling</i>
http://youtu.be/fz9Irgm0lyg	<i>Fight or Flight Amplification Cascade</i>
http://youtu.be/Czs2hIWvCQQ	<i>Receptor Kinase Ligand Binding</i>
http://youtu.be/FjS6HtpLOgE	<i>Receptor Tyrosine Kinase Activation</i>
http://youtu.be/m9cVMHFkDhY	<i>Receptor Kinase e.g., Mitogenic Pathway</i>
http://youtu.be/CkeYBSD9RjQ	<i>Microtubule Polarity Experiment</i>
http://youtu.be/1PSenpp7TmE	<i>Spindle Fibers Exert Force on Chromatids</i>
http://youtu.be/Y6RBJfUpZec	<i>Sliding Microtubules</i>
http://youtu.be/zsKhdjIAw8s	<i>Reconstituted Sarcomere Contraction</i>
http://youtu.be/CrB7A_DAk3I	<i>Myosin Head Allostery During Sliding Along Actin</i>
http://youtu.be/HpZpA-vYDBU	<i>Calcium Release from Sarcoplasmic Reticulum</i>
http://youtu.be/LvDSi7xtdYo	<i>Actin and Cytokinesis</i>
http://youtu.be/QL7M_j4LjVc	<i>Bcl2 Gene Activation in Apoptosis</i>
http://youtu.be/x3-ZKUbY_SY	<i>Caspase Activation leads to Apoptosis</i>